

Welding Consumables

Product Catalogue



www.lincolnelectric.eu

LINCOLN[®]
ELECTRIC
THE WELDING EXPERTS[®]

PACKAGING SOLUTIONS

STICK ELECTRODES



CARDBOARD: The cost effective solution for regular applications without special requirements



PROTECH™: Competitive vacuum packaging for stick electrodes



SAHARA READYPACK®: The best vacuum pack for the most demanding applications that require an absolute guarantee for low diffusible hydrogen and/or low moisture level



LINC CAN™: for severe working conditions and when a guarantee on moisture absorption resistance is needed



LINC PACK: 1kg-pack, ideal for maintenance & repair welding and for small welding jobs in general



PE tube



ROD OVEN HYDROGUARD™ Protect your stick electrodes from moisture pick up and prevent weld cracking and porosity

TABLE OF CONTENTS

GENERAL INFORMATION	4
STICK ELECTRODES	63
MIG/MAG WIRES	296
TIG WIRES	357
FLUX-CORED WIRES	405
SUBMERGED ARC CONSUMABLES	526
PIPELINER RANGE	603
CERAMIC BACKING MATERIALS	640

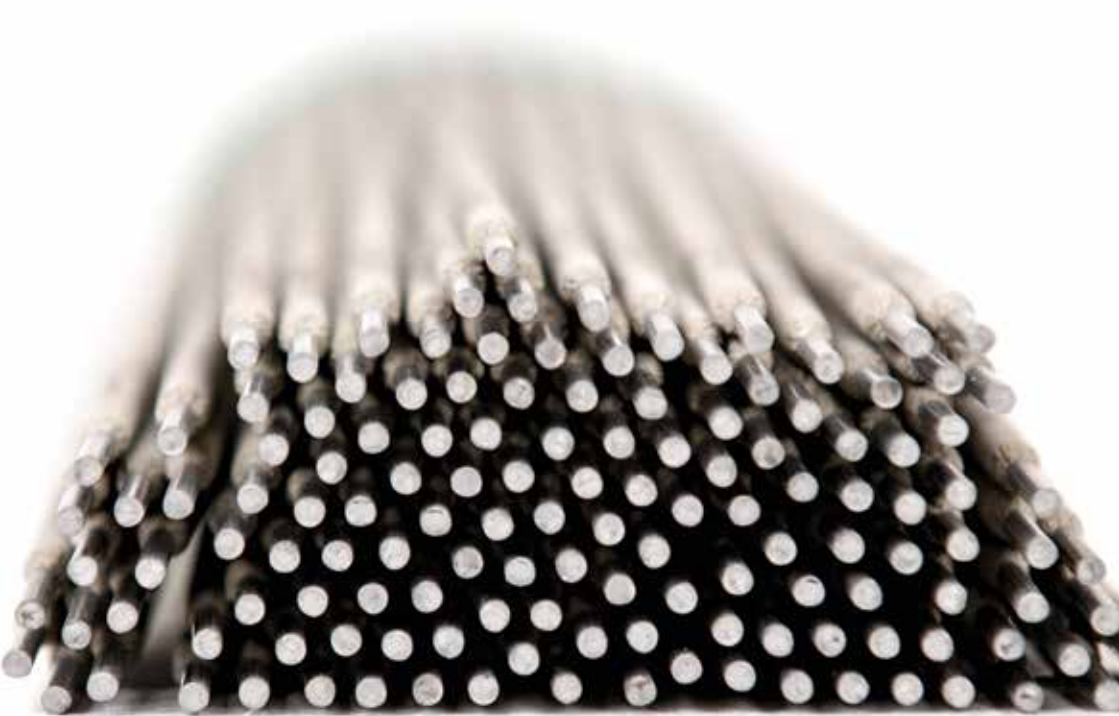

GENERAL INFORMATION

Chemical composition & Classification..... 8

Corresponding welding consumables25

EN/ISO classification.....30

A/F/M Numbers35

Welding positions.....36

Selection tables.....38

Cost calculations for steel constructions with stick electrodes48

Ferrite in weld metal..... 51

Packaging and sizes54

Sahara® ReadyPack®57

Storage and handling.....58

DATASHEETS COVERED ELECTRODES

Mild and Fine Grained Steel

Fleetweld® 5P+..... 64

Supra®66

Omnia®68

Pantafx®70

Omnia® 4672

Numal.....74

Cumulo®76

Universalis®78

Rental.....80

Ferrod® 165A82

Ferrod® 135T84

Ferrod® 160T86

Gonia 18088

Baso® 48SP90

Basic 701892

Baso® 51P94

Lincoln 7016 DR.....96

Baso® 10098

Baso® 120100

Baso® G102

Baso® 26V.....104

Vandal.....106

Conarc® 48108

Conarc® 49110

Conarc® 49C112

Conarc® One114

Conarc® 50116

Conarc® 51118

Conarc® 52120

Lincoln 7018-1.....122

Conarc® L150124

Conarc® V180126

Kardo.....128

Low Alloy Steel

Shield Arc® HYP+..... 130

Shield Arc® 70+132

Conarc® 55CT.....134

Conarc® 60G136

Conarc® 70G.....138

Conarc® 74140

Conarc® 80142

Conarc® 85144

Kryo® 1146

Kryo® 1N.....148

Kryo® 1P..... 150

Kryo® 1-145.....152

Kryo® 1-180.....154

Kryo® 2.....156

Kryo® 3.....158

Kryo® 4.....160

SL®12G.....162

SL®19G.....164

SL®20G.....166

SL®22G.....168

SL®502170

SL®9Cr(P91)172

Stainless and Heat Resistant Steel

Arosta® 304L174

Limarosta® 304L176

Vertarosta® 304L178

Jungo® 304L180

Arosta® 347182

Jungo® 347184

Arosta® 316L186

Limarosta® 316L188

Vertarosta® 316L190

Jungo® 316L192

Limarosta® 316L-130194

Arosta® 318.....196

Jungo® 4465198

Jungo® 4500.....200

Arosta® 4462202

Jungo® 4462204

Jungo® 309L206

Arosta® 309S208

Limarosta® 309S.....210

Arosta® 309Mo212

Nichroma214

Nichroma 160216

Limarosta® 312218

Arosta® 307220

Arosta® 307-160222

Jungo® 307224

Arosta® 304H226

Arosta® 309H.....228

Intherma® 310230

Intherma® 310B.....232

Lincox P 308L234

Lincox 308L236

Lincox P 316L238

Lincox 316L240

Lincox P 309L242

Lincox 309L244

Nickel alloys

NiCro 31/27..... 246

NiCro 60/20.....248

NiCro 70/15250

NiCro 70/15Mn252

NiCro 70/19.....254

NYLOID 2256

NYLOID 4258

Aluminium Alloys

AlMn260

AlSi5.....262

AlSi12.....264

Hardfacing Applications

Wearshield® BU-30266

Wearshield® Mangjet (e).....268

Wearshield® 15CrMn270

Wearshield® MM 40272

Wearshield® MM274

Wearshield® T&D276

Wearshield® MI (e).....278

Wearshield® ABR.....280
 Wearshield® ME (e).....282
 Wearshield® 60 (e).....284
 Wearshield® 70.....286
 Wearshield® 420.....288

Cast Iron

RepTec Cast 1.....290
 RepTec Cast 3.....292
 RepTec Cast 31.....294

DATASHEETS MIG WIRES

Typical Operations Procedures297

Mild Steel

LNM 25298
 UltraMag®299
 UltraMag® G4Si1300
 SupraMIG®301
 SupraMIG® CF302
 SupraMig® HD303
 SupraMIG Ultra®304
 SupraMIG Ultra® CF305
 SupraMig Ultra® HD306

Low Alloy Steel

LNM 28307
 LNM MoNi308
 LNM MoNiVa309
 LNM MoNiCr310
 LNM Ni1311
 LNM Ni2.5312
 LNM 12313
 LNM 19314
 LNM 20315

Stainless Steel

LNM 304LSi316
 LNM 304L317
 LNM 347Si318
 LNM 316LSi319
 LNM 318Si320
 LNM 4439Mn321
 LNM 4455322
 LNM 4362323
 LNM 4462324
 LNM 4500325
 LNM 2507326
 LNM 309LSi327
 LNM 307328
 LNM 304H329
 LNM 309H330
 LNM 310331
 LNM 312332

Nickel alloys

LNM CuAl8338
 LNM CuAl8Ni6339
 LNM CuNi30340
 LNM CuSn341
 LNM CuSi3342

Copper alloys

LNM CuAl8340
 LNM CuAl8Ni6341
 LNM CuNi30342
 LNM CuSn343
 LNM CuSi3344

Aluminium alloys

SuperGlaze® MIG 1070343
 SuperGlaze® MIG 1100344
 SuperGlaze® MIG 2319345

SuperGlaze® MIG 4043346
 SuperGlaze® MIG 4047347
 SuperGlaze® MIG 5087348
 SuperGlaze® MIG 5183349
 SuperGlaze® MIG 5356350
 SuperGlaze® MIG 5356 TM351
 SuperGlaze® MIG 5556352
 SuperGlaze® MIG 5556A353
 SuperGlaze® MIG 5754354

Hardfacing

LNM 420FM355
 LNM 4M356

DATASHEETS TIG WIRES

Mild Steel

LNT 25358
 LNT 26359

Low Alloy Steel

LNT 28360
 LNT Ni1361
 LNT NiMo1362
 LNT Ni2.5363
 LNT 12364
 LNT 19365
 LNT 20366
 LNT 502367
 LNT 9Cr(P91)368

Stainless Steel

LNT 304LSi369
 LNT 304L370
 LNT 347Si371
 LNT 316LSi372
 LNT 316L373
 LNT 318Si374
 LNT 4439Mn375
 LNT 4500376
 LNT 4462377
 LNT Zeron® 100X378
 LNT 309LHF379
 LNT 309LSi380
 LNT 309L381
 LNT 304H382
 LNT 310383

Nickel alloys

LNT NiCro 60/20384
 LNT NiCro 70/19385
 LNT NiCroMo 59/23386
 LNT NiCu 70/30387
 LNT NiTi388

Copper alloys

LNT CuNi30389
 LNT CuSn6390
 LNT CuSi3391

Aluminium alloys

SuperGlaze® TIG 1070392
 SuperGlaze® TIG 1100393
 SuperGlaze® TIG 4043394
 SuperGlaze® TIG 4047395
 SuperGlaze® TIG 5183396
 SuperGlaze® TIG 5183397
 SuperGlaze® TIG 5356398
 SuperGlaze® TIG 5554399
 SuperGlaze® TIG 5754400

All information in this data sheet is accurate to the best of our knowledge at the time of printing. Please refer to www.lincolnelectric.eu for any updated information.
 Fumes: Safety Data Sheets (SDS) are available on our website.

Autogenous Wires

LNG I401
 LNG II402
 LNG IV403

DATASHEETS FLUX-CORED WIRES

OUTERSHIELD (gas shielded)

Metal cored, un-and low alloyed

Outershield® MC700406
 Outershield® MC710-H408
 Outershield® MC710C-H410
 Outershield® MC715-H412
 Outershield® MC715-Ni1-H414
 Outershield® MC420N-H416
 Outershield® MC460VD-H418

Rutile and Basic, Un-alloyed

Outershield® 70-H420
 Outershield® 71E-H422
 Outershield® 71M-H424
 Outershield® 71MS-H426
 Outershield® T55-H428

Rutile, low alloyed, gas shielded

Outershield® 81Ni1-H430
 Outershield® 81Ni1-HSR432
 Outershield® 81NiC-H434
 Outershield® 81K2-H436
 Outershield® 81K2-HSR438
 Outershield® 91Ni1-HSR440
 Outershield® 91K2-HSR442
 Outershield® 101Ni1-HSR444
 Outershield® 690-H446
 Outershield® 690-HSR448

Rutile and Metal Cored, weather resistant

Outershield® 500CT-H450
 Outershield® 555CT-H452
 Outershield® MC555CT-H454

Rutile, Heat and Creep Resistant

Outershield® 12-H456
 Outershield® 19-H458
 Outershield® 20-H460

INNERSHIELD (self shielded)

Innershield® NR®-152462
 Innershield® NR®-203 NiC464
 Innershield® NR®-203Ni1466
 Innershield® NR®-211-MP468
 Innershield® NR®-232470
 Innershield® NR®-233472
 Innershield® NR®-207-H474
 Innershield® NR®-208-H476
 Innershield® NR®-305478
 Innershield® NR®-311480
 Innershield® NR®-400482
 Innershield® NS®-3M484

COR-A-ROSTA (stainless steel, gas shielded)

Cor-A-Rosta® 304L486
 Cor-A-Rosta® P304L488
 Cor-A-Rosta® 347490
 Cor-A-Rosta® 316L492
 Cor-A-Rosta® P316L494
 Cor-A-Rosta® 309L496
 Cor-A-Rosta® P309L498
 Cor-A-Rosta® 309MoL500
 Cor-A-Rosta® P309MoL502
 Cor-A-Rosta® 4462504
 Cor-A-Rosta® P4462506

LINCORE, Hardfacing, self shielded

Lincore® 33508
 Lincore® 40-0510
 Lincore® 50512
 Lincore® 55514
 Lincore® 60-0516
 Lincore® T&D518
 Lincore® 15CrMn520
 Lincore® 420522
 Lincore® M524

DATASHEETS SUBMERGED ARC CONSUMABLES

Mild steel, Solid Wires

L-60527
 L-61528
 LNS 135529
 L-50M530

Low Alloy Solid Wires

L-70531
 LNS 140A532
 LNS 133TB533
 LNS 140TB534
 LNS 150535
 LNS 151536
 LNS 160537
 LNS 162538
 LNS 163539
 LNS 164540
 LNS 165541
 LNS 168542
 LNS 175543

Mild Steel Flux-Cored Wires

LNS T55544

Stainless Steel Solid Wires

LNS 304L545
 LNS 304H546
 LNS 307547
 LNS 309L548
 LNS 316L549
 LNS 318550
 LNS 347551
 LNS 4455552
 LNS 4462553
 LNS 4500554
 LNS Zeron® 100X555

Nickel base Solid Wires

LNS NiCro 60/20556
 LNS NiCro 70/19557
 LNS NiCro Mo 60/16558

Fluxes

842-H572
 8500574
 860576
 888578
 960580
 980582
 995N584
 998N586
 P223588
 P230592
 P240594
 P2000596
 P2007598
 P2000S600

All information in this data sheet is accurate to the best of our knowledge at the time of printing. Please refer to www.lincolnelectric.eu for any updated information. Fumes: Safety Data Sheets (SDS) are available on our website.

DATASHEETS PIPELINER® RANGE

Cellulosic Electrodes

PIPELINER® 6P+ 604
 PIPELINER® 7P+ 606
 PIPELINER® 8P+ 608

Basic Electrodes

PIPELINER® 16P 610
 PIPELINER® 18P 612

High Strength, Basic Electrodes

PIPELINER® LH-D80 614
 PIPELINER® LH-D90 616
 PIPELINER® LH-D100 618

Solid Wires

PIPELINER® 70S-G 620
 PIPELINER® 80S-G 621
 PIPELINER® 80Ni1 622

Flux-cored Wires

PIPELINER® G60M-E 624
 PIPELINER® G70M 626
 PIPELINER® G70M-E 628
 PIPELINER® G80M 630
 PIPELINER® G80M-E 632
 PIPELINER® G90M-E 634
 PIPELINER® NR®-207+ 636
 PIPELINER® NR®-208XP 638

CERAMIC BACKING MATERIALS 640

COVERED ELECTRODES FOR MILD AND FINE GRAINED STEEL

Product name	Chemical composition (typical values) in %						AWS	EN/ISO
	C	Mn	Si	P	S			
Fleetweld [®] SP+	0.20	0.56	0.17	-	-	A5.1	E6010	ISO 2560-A E 42 3 C 2 5
Supra [®]	0.12	0.5	0.6	-	-	A5.1	E6012	ISO 2560-A E 38 0 RC 1 1
Omnia [®]	0.07	0.5	0.5	-	-	A5.1	E6013	ISO 2560-A E 42 0 RC 1 1
Pantafix	0.09	0.5	0.4	-	-	A5.1	E6013	ISO 2560-A E 38 0 RC 1 1
Omnia [®] 46	0.06	0.5	0.45	-	-	A5.1	E6013	ISO 2560-A E 38 0 R 1 1
Numal	0.06	0.5	0.45	-	-	A5.1	E6013	ISO 2560-A E 38 0 R 1 1
Cumulo [®]	0.1	0.5	0.4	-	-	A5.1	E6013	ISO 2560-A E 38 0 R 1 2
Universalis [®]	0.1	0.6	0.4	-	-	A5.1	E6013	ISO 2560-A E 42 0 RR 1 2
Rental	0.07	0.8	0.5	-	-	A5.1	E7024	ISO 2560-A E 38 0 RR 7 3
Ferrod 165A	0.07	0.95	0.3	-	-	A5.1	E7024-1	ISO 2560-A E 42 2 RA 7 3
Ferrod 135T	0.08	0.5	0.35	-	-	A5.1	E7024	ISO 2560-A E 38 0 RR 5 3
Ferrod 160T	0.07	0.9	0.6	-	-	A5.1	E7024	ISO 2560-A E 42 0 RR 7 3
Gonia 180	0.07	1.0	0.35	-	-	A5.1	E7024	ISO 2560-A E 42 0 RR 7 3
Baso [®] 48 SP	0.075	1.4	0.45	-	-	A5.1	E7018-1H8	ISO 2560-A E 46 3 B 3 2 H10*
Basic 7018	0.05	1.3	0.4	-	-	A5.1	E7018 H4	ISO 2560-A E 42 2 B 1 2 H10
Baso [®] 51P	0.06	1.3	0.5	0.015	0.01	A5.1	E7018-1	ISO 2560-A E 46 3 B 3 2 H 5
Lincoln 7016 DR	0.08	1.2	0.6	-	-	A5.1	E7016	ISO 2560-A E 42 3 B 1 2 H 5
Baso [®] 100	0.08	1.0	0.5	-	-	A5.1	E7016 H4R	ISO 2560-A E 42 3 B 1 2 H 5
Baso [®] 120	0.08	1.2	0.5	-	-	A5.1	E7018 H4R	ISO 2560-A E 42 3 B 3 2 H 5
Baso [®] G	0.05	1.3	0.4	-	-	A5.1	E7018-1H4R	ISO 2560-A E 42 5 B 3 2 H 5
Baso [®] 26V	0.09	1.1	0.7	-	-	A5.1	E7048 H8	ISO 2560-A E 42 3 B 1 5 H10
Vandal	0.07	1.2	0.5	-	-	A5.1	E7018-1H4R	ISO 2560-A E 42 4 B 3 2 H 5
Conarc [®] 48	0.05	1.3	0.3	-	-	A5.1	E7018-1H4	ISO 2560-A E 46 4 B 4 2 H 5
Conarc [®] 49	0.09	1.1	0.6	0.015	0.010	A5.1	E7018 H4	ISO 2560-A E 46 3 B 4 2 H 5
Conarc [®] 49C	0.06	1.4	0.3	0.015	0.010	A5.1	E7018-1H4R	ISO 2560-A E 46 4 B 3 2 H 5
Conarc [®] One	0.05	1.3	0.4	0.015	0.010	A5.1	E7018-1H4R	ISO 2560-A E 42 5 B 3 2 H 5
Conarc [®] 50	0.05	1.0	0.3	--	-	A5.1	E7018-1H4	ISO 2560-A E 46 5 B 4 2 H 5
Conarc [®] 51	0.06	1.4	0.5	0.015	0.010	A5.1	E7016-1H4R	ISO 2560-A E 42 4 B 1 2 H 5
Conarc [®] 52	0.06	1.2	0.4	0.015	0.010	A5.1	E7016	ISO 2560-A E 42 2 B 1 2 H 5
LINCOLN [®] 7018-1	0.05	1.0	0.3	0.015	0.010	A5.1	E7018-1	ISO 2560-A E 46 3 B 3 2 H 5
Conarc [®] Li50	0.07	0.95	0.4	0.015	0.010	A5.1	E7028 H4R	ISO 2560-A E 42 2 B 5 3 H 5
Conarc [®] V180	0.08	1.2	0.3	0.015	0.010	A5.1	E7028 H4R	ISO 2560-A E 42 4 B 7 3 H 5
Kardio [®]	0.03	0.4	0.25	0.015	0.010	A5.1	E6018 ¹⁾	ISO 2560-A E 35 2 B 3 2 H 5

¹⁾ according classification 1966

* also complies to E 46 3 BR 32 H10

COVERED ELECTRODES FOR LOW ALLOY STEEL (HIGH YIELD, LOW TEMPERATURE AND CREEP RESISTANT STEEL)

Product	Chemical composition [typical values] in %													AWS	EN/ISO	
	C	Mn	Si	Ni	Cr	Mo	Cu	V	Nb	N	P	S				
Shield Arc [®] HYP+	0.13-0.17	0.49-0.63	0.08-0.18	-	-	0.27-0.31	-	<0.01	-	-	-	-	A5.5	E 7010-P1	ISO 2560-A	E 42.2 Mo C 2.5
Shield Arc [®] 70+	0.13-0.17	0.6-1.2	0.05-0.3	0.75-0.97	0.01-0.2	0.05-0.15	0.02-0.04	-	-	-	-	-	A5.5	E 8010-G	ISO 2560-A	E 46.4 TnI C 2.5
Conarc [®] 55CT	0.05	1.5	0.4	0.9	-	-	0.4	-	-	-	-	-	A5.5	E 8018-V2-H4R [§]	ISO 2560-A	E 46.5 MnNi B 3.2 H5
Conarc [®] 60G	0.06	1.0	0.4	1.6	-	0.3	-	-	-	-	-	-	A5.5	E 9018M-H4	EN-ISO 18275	E 55.4 Z B 3.2 H5
Conarc [®] 70G	0.06	1.2	0.4	1.0	-	0.4	-	-	-	-	-	-	A5.5	E 9018-G-H4R	EN-ISO 18275	E 55.4 Z B 3.2 H5
Conarc [®] 74	0.05	1.5	0.5	0.95	-	-	-	-	-	-	-	-	A5.5	E 8018-G-H4R	ISO 2560-A	E 50.6 MnNi B 3.2 H5
Conarc [®] 80	0.06	1.5	0.4	2.2	-	0.4	-	-	-	-	-	-	A5.5	E 11018M-H4	EN-ISO 18275	E 69.5 Z B 3.2 H5
Conarc [®] 85	0.06	1.4	0.3	2.0	0.4	0.4	-	-	-	-	-	-	A5.5	E 12018-G-H4R	EN-ISO 18275	E 69.5 Mn2NiCrMo B 3.2 H5
Kryo [®] 1	0.05	1.5	0.4	0.9	-	-	-	-	-	-	-	-	A5.5	E 7018-G-H4R [§]	ISO 2560-A	E 50.6 MnNi B 3.2 H5
Kryo [®] 1N	0.07	1.7	0.5	0.9	-	-	-	-	-	-	-	-	A5.5	E 8016-G-H4R	ISO 2560-A	E 50.6 MnNi B 1.2 H5
Kryo [®] 1P	0.05	1.5	0.5	0.95	-	-	-	-	-	-	-	-	A5.5	E 8018-G-H4R	ISO 2560-A	E 50.6 MnNi B 3.2 H5
Kryo [®] 1-145	0.06	1.5	0.5	0.9	-	-	-	-	-	-	-	-	A5.5	E 8018-G-H4R	ISO 2560-A	E 50.6 MnNi B 5.3 H5
Kryo [®] 1-180	0.07	1.2	0.3	0.9	-	-	-	-	-	-	-	-	A5.5	E 8018-G-H4R	ISO 2560-A	E 50.5 TnI B 7.3 H5
Kryo [®] 2	0.05	1.6	0.3	1.5	-	-	-	-	-	-	-	-	A5.5	E 9018-G-H4R	EN-ISO 18275	E 55.6 Z B 3.2 H5
Kryo [®] 3	0.05	0.7	0.3	2.5	-	-	-	-	-	-	-	-	A5.5	E 8018-C1-H4	ISO 2560-A	E 46.8 3Ni B 3.2 H5*
Kryo [®] 4	0.03	0.6	0.4	3.6	-	-	-	-	-	-	-	-	A5.5	E 7016-C2L-H4R	ISO 2560-A	E 38.8 3Ni B 3.2 H5
SL 702	0.05	0.8	0.6	-	-	0.55	-	-	-	-	-	-	A5.5	E 7018-A1-H4R	ISO 3580-A	E Mo B 3.2 H5
SL 19G	0.06	0.75	0.6	-	1.1	0.5	-	-	-	-	-	-	A5.5	E 8018-B2-H4	ISO 3580-A	E CrMo1 B 3.2 H5
SL 20G	0.06	0.8	0.6	-	2.3	1.0	-	-	-	-	-	-	A5.5	E 9018-B3-H4	ISO 3580-A	E CrMo2 B 3.2 H5
SL 22G	0.06	0.8	0.6	-	0.5	0.5	-	0.3	-	-	-	-	A5.5	E 8018-B1-H4	ISO 3580-A	E Z B 3.2 H5
SL 502	0.07	0.8	0.6	-	5.3	0.6	-	-	-	-	-	-	A5.5	E 8018-B6-H4R	ISO 3580-A	E CrMo5 B 3.2 H5
SL 9Cr (P9)	0.09	0.6	0.2	0.6	9.0	1.0	-	0.2	0.04	0.010	0.010	0.010	A5.5	E 9016-B9-H4	ISO 3580-A	E CrMo91 B 3.2 H5

[§]For deviations, consult datasheet

^{*}meet also AWS A5.5: E8018-G-H4R

COVERED ELECTRODES FOR STAINLESS AND HEAT RESISTANT STEEL

Product name	Chemical composition (typical values) in %										AWS	EN/ISO		
	C	Mn	Si	Cr	Ni	Mo	Nb	Cu	N	W				
Arosta® 304L	0.02	0.80	0.80	19.5	9.7	-	-	-	-	-	-	-	ISO 3581-A	E 19 9 LR 12
Limarosta® 304L	0.025	0.75	0.95	19.0	9.7	-	-	-	-	-	-	-	ISO 3581-A	E 19 9 LR 12
Vertarosta® 304L	0.02	0.8	0.7	20.0	9.8	-	-	-	-	-	-	-	ISO 3581-A	E 19 9 LR 21
Jungo® 304L	0.025	1.8	0.4	19.0	10.0	-	-	-	-	-	-	-	ISO 3581-A	E 19 9 L B 22
Arosta® 347	0.03	0.8	0.8	19.5	9.8	-	0.35	-	-	-	-	-	ISO 3581-A	E 19 9 Nb R 12
Jungo® 347	0.02	1.6	0.5	20.0	10.0	-	0.40	-	-	-	-	-	ISO 3581-A	E 19 9 Nb B 22
Arosta® 316L	0.02	0.8	0.8	18.0	11.5	2.85	-	-	-	-	-	-	ISO 3581-A	E 19 12 3 LR 12
Limarosta® 316L	0.02	0.8	1.0	18.0	11.5	2.8	-	-	-	-	-	-	ISO 3581-A	E 19 12 3 LR 12
Vertarosta® 316L	0.02	0.7	0.85	18.0	11.5	2.8	-	-	-	-	-	-	ISO 3581-A	E 19 12 3 LR 21
Jungo® 316L	0.025	1.6	0.4	18.5	11.0	2.7	-	-	-	-	-	-	ISO 3581-A	E 19 12 3 L B 22
Limarosta® 316L-130	0.02	0.65	1.0	18.0	11.5	2.8	-	-	-	-	-	-	ISO 3581-A	E 19 12 3 L R 53
Arosta® 318	0.03	0.8	0.85	18.0	11.5	2.7	0.35	-	-	-	-	-	ISO 3581-A	E 19 12 3 Nb R 12
Jungo® 4465	0.03	4.5	0.4	25.0	22.0	2.2	-	0.13	-	-	-	-	ISO 3581-A	E 25 22 2 N L B 22*
Jungo® 4500	0.02	1.2	0.9	20.0	25.0	5.0	-	1.5	-	-	-	-	ISO 3581-A	E 20 25 5 Cu N L R 12
Arosta® 4462	0.02	0.8	1.0	22.5	9.5	3.2	-	-	0.16	-	-	-	ISO 3581-A	E 22 09 3 N L R 32
Jungo® 4462	0.025	1.6	0.5	23.5	9.0	3.0	-	-	0.15	-	-	-	ISO 3581-A	E 22 9 3 N L B 22
Jungo® 309L	0.025	1.5	0.4	23.0	13.0	-	-	-	-	-	-	-	ISO 3581-A	E 23 12 L B 22
Arosta® 309S	0.02	0.8	0.8	23.5	12.5	-	-	-	-	-	-	-	ISO 3581-A	E 23 12 L R 32
Limarosta® 309S	0.02	0.8	1.0	23.0	12.5	-	-	-	-	-	-	-	ISO 3581-A	E 23 12 L R 32
Arosta® 309Mo	0.025	0.8	0.8	23.0	12.5	2.7	-	-	-	-	-	-	ISO 3581-A	E 23 12 2 L R 32
Nichroma	0.025	0.8	1.0	20.0	9.5	2.3	-	-	-	-	-	-	ISO 3581-A	E 20 10 3 R 32
Nichroma 160	0.05	0.7	1.0	23.7	12.8	2.4	-	-	-	-	-	-	ISO 3581-A	E 23 12 2 LR 53*
Arosta® 329	0.08	0.7	1.2	25.0	4.5	-	-	-	-	-	-	-	ISO 3581-A	E 25 4 R 12*
Limarosta® 312	0.11	0.9	1.0	29.0	9.0	-	-	-	-	-	-	-	ISO 3581-A	E 29 9 R 12
Arosta® 307	0.09	5.0	0.6	18.5	8.5	-	-	-	-	-	-	-	ISO 3581-A	E 18 8 Mn R 12
Arosta® 307-160	0.06	6.0	1.0	18.0	8.0	-	-	-	-	-	-	-	ISO 3581-A	E 18 8 Mn R 53
Jungo® 307	0.08	5.5	0.3	19.0	8.5	-	-	-	-	-	-	-	ISO 3581-A	E 18 8 Mn B 22
Arosta® 304H	0.05	0.75	0.85	18.5	9.5	-	-	-	-	-	-	-	ISO 3581-A	E 19 9 H R 12
Arosta® 309H	0.10	0.8	1.6	22.0	11.0	-	-	-	-	-	-	-	ISO 3581-A	E 23 12 R 32*
Intherma® 310	0.12	2.5	0.5	26.0	20.5	-	-	-	-	-	-	-	ISO 3581-A	E 25 20 R 12
Intherma® 310B	0.1	3.0	0.3	25.0	21.0	-	-	-	-	-	-	-	ISO 3581-A	E 25 20 B 12
Linnox P 308L	0.025	0.8	0.6	19.0	9.5	-	-	-	-	-	-	-	ISO 3581-A	E 19 9 L R 32
Linnox 308L	0.025	0.8	0.8	19.0	9.5	-	-	-	-	-	-	-	ISO 3581-A	E 19 9 L R 32
Linnox P 316L	0.025	0.8	0.6	19.0	12.0	2.5	-	-	-	-	-	-	ISO 3581-A	E 19 12 3 L R 32
Linnox 316L	0.025	0.8	0.8	18.0	12.0	2.5	-	-	-	-	-	-	ISO 3581-A	E 19 12 3 L R 32
Linnox P 309L	0.025	0.8	0.6	23.5	13.0	-	-	-	-	-	-	-	ISO 3581-A	EE 23 12 L R 32
Linnox 309L	0.025	0.7	0.7	24.0	12.5	-	-	-	-	-	-	-	ISO 3581-A	E 23 12 L R 32

*For deviations, consult datasheet

COVERED ELECTRODES FOR NICKEL BASE ALLOYS

Product name	Chemical composition (typical values) in %											AWS	EN/ISO			
	C	Mn	Si	Fe	Cr	Ni	Mo	Cu	Nb	W	Ti			S		
NiCro 31/27	0.02	0.8	0.9	bal.	27	31.0	3.5	0.9	-	-	-	-	A5.4	E383-16	ISO 3581-A	E 27 31 4 Cu L R 12
NiCro 60/20	0.03	0.5	0.35	0.9	22	62	9	-	3.4	-	-	-	A5.11/A5.11M	ENiCrMo-3	ISO 14772	E Ni 6625 (NiCr22Mo9Nb)
NiCro 70/15	0.02	4.4	0.45	6	18	bal.	-	-	1.9	-	-	-	A5.11/A5.11M	ENiCrFe-2*	ISO 14772	E Ni 6182* (NiCr15Fe6Mn)*
NiCro 70/15Mn	0.025	5.5	0.4	6.5	16	bal.	-	-	2.0	-	-	-	A5.11/A5.11M	ENiCrFe-3	ISO 14772	E Ni 6182 (NiCr15Fe6Mn)
NiCro 70/19	0.03	4.7	0.6	4.0	bal.	bal.	1.5	-	1.9	-	-	-	A5.11/A5.11M	ENiCrFe-2*	ISO 14772	E Ni 6082 (NiCr20Mn3Nb)
NiVLOID 2	0.05	3.0	0.4	6	13	68	6	-	1.5	1.5	-	-	A5.11/A5.11M	ENiCrMo-6	ISO 14772	E Ni 6620 (NiCr14Mo7Fe)
NiVLOID 4	0.05	3.0	0.4	6	13	bal.	6.5	-	1.5	1.5	-	-	A5.11/A5.11M	ENiCrMo-6	ISO 14772	E Ni 6620 (NiCr14Mo7Fe)

* For deviations, consult datasheet

COVERED ELECTRODES FOR ALUMINIUM ALLOYS

Product name	Chemical composition (typical values) in %										AWS	EN/ISO	
	Mn	Si	Fe	Cu	Al	Mg	Zn	Ti	Others				
AlMn	0.9-1.2	0.3 max.	0.6 max.	0.02 max.	Bal.	0.15 max.	0.09 max.	-	0.15 max.	A5.3	E3003*	ISO 18273	Al 3103 (AlMn)
AlSi5	-	5.0	-	-	Bal.	-	-	-	-	A5.3	E4043	ISO 18273	Al 4043A* (AlSi5[Al])
AlSi2	-	12.0	-	-	Bal.	-	-	-	-	-	-	ISO 18273	Al 4047A (AlSi2[Al])

* For deviations, consult datasheet

COVERED ELECTRODES FOR REPAIR WELDING

Product name	Chemical composition (typical values) in %											AWS	DIN	EN/ISO		
	C	Mn	Si	Cr	Mo	W	V	Nb	B	Ti						
Wearshield® BU-30	0.2	0.8	1.0	1.5	0.5	-	-	-	-	-	-	-	DIN 8555	E1-UM-350-GP	EN 14700	E Fe1
Wearshield® Manglet (e)	0.7	15	-	3.7	-	-	-	-	-	-	-	-	DIN 8555	E7-UM-200-KP	EN 14700	E Fe9
Wearshield® 15CrMn	0.35	14.0	0.6	15.0	-	-	-	-	-	-	-	A513	E Fe9	EN 14700	E Fe9	
Wearshield® MM 40	0.2	0.5	1.3	3.4	0.5	-	-	-	-	-	-	-	DIN 8555	E1-UM-400-G*	EN 14700	E Fe1
Wearshield® MM	0.55	0.5	1.5	4.5	0.5	0.5	-	-	-	-	-	-	DIN 8555	E2-UM-55-G*	EN 14700	E Fe2
Wearshield® TGD	0.65	0.4	0.5	4	6.5	2.6	1.1	-	-	-	-	A513	E Fe6*	EN 14700	E Fe4	
Wearshield® Ml (e)	0.5	0.4	1.8	9	-	-	-	-	-	-	-	A513	E Fe6	EN 14700	E Fe6	
Wearshield® ABR	2.1	1.1	0.75	6.5	0.40	-	-	-	-	-	-	-	DIN 8555	E10-UM-50-GPZ	EN 14700	E Fe6
Wearshield® ME (e)	3	-	1.0	33	-	-	-	-	-	-	-	-	DIN 8555	E10-UM-60-GRZ	EN 14700	E Fe14
Wearshield® 60 (e)	5	-	4	35	-	-	-	-	-	-	-	-	DIN 8555	E10-UM-60-GR	EN 14700	E Fe15
Wearshield® 70	4.2	-	2.7	18	8.5	7	-	9	-	-	-	-	DIN 8555	E10-UM-65-GRZ	EN 14700	E Fe16
Wearshield® 420	0.5	0.3	0.4	12.4	0.4	-	1.3	-	-	-	-	-	DIN 8555	E6-UM-55-RZ	EN 14700	E Fe8

*Nearest Classification

COVERED ELECTRODES FOR REPAIR WELDING

Product name	Chemical composition (typical values) in %							AWS	EN/ISO	
	C	Mn	Si	Ni	Cr	Fe				
Rep Tec Cast 1	0.7	-	-	97	-	2.0	A515	ENi-C1	ISO 1071	E C Ni-C11
Rep Tec Cast 3	0.6	-	-	balance	-	40	A515	ENiFe-C1	ISO 1071	E C NiFe-C11
Rep Tec Cast 31	0.7	-	-	balance	-	45	A515	ENiFe-C1	ISO 1071	E C NiFe-C11

MIG WIRES FOR MILD STEEL

Product name	Chemical composition (typical values) in %					AWS	EN/ISO
	C	Mn	Si				
LNM25	0.08	1.10	0.60	A5.18/A5.18M		ER70S-3	EN ISO 14341-A G 42.4 M 25I
UltraMag®	0.078	1.40	0.85	A5.18/A5.18M		ER70S-6	EN ISO 14341-A G 46.4 M 35I1 / G 42.3 C 35I1
UltraMag® 645I1	0.08	1.70	0.85	A5.18/A5.18M		ER70S-6	EN ISO 14341-A G 46.5 M 45I1/G 46.3 C 45I1
SupraMIG®	0.08	1.40	0.85	A5.18/A5.18M		ER70S-6	EN ISO 14341-A G 46.4 M 35I1 / G 42.3 C 35I1
SupraMIG® CF	0.08	1.40	0.85	A5.18/A5.18M		ER70S-6	EN ISO 14341-A G 46.4 M 35I1 / G 42.3 C 35I1
SupraMIG® HD	0.08	1.40	0.85	A5.18/A5.18M		ER70S-6	EN ISO 14341-A G 46.4 M 35I1 / G 42.3 C 35I1
SupraMIG Ultra®	0.08	1.70	0.85	A5.18/A5.18M		ER70S-6	EN ISO 14341-A G 50.5 M 45I1 / G 46.3 C 45I1
SupraMIG Ultra CF	0.08	1.70	0.85	A5.18/A5.18M		ER70S-6	EN ISO 14341-A G 50.5 M 45I1 / G 46.3 C 45I1
SupraMIG Ultra HD	0.08	1.70	0.85	A5.18/A5.18M		ER70S-6	EN ISO 14341-A G 50.5 M 45I1 / G 46.3 C 45I1

MIG WIRES FOR LOW ALLOY STEEL

Product name	Chemical composition (typical values) in %											AWS	EN/ISO	
	C	Mn	Si	Ni	Cu	Cr	Mo	V	Ti	N				
LNM28	0.10	1.4	0.75	0.8	0.3	-	-	-	-	-	-	A5.28	ER80S-G	EN ISO 16834-A G Z Mn3Ni1Cu*
LNM1MoNi	0.10	1.65	0.75	0.55	0.08	0.60	0.30	-	-	-	-	A5.28	ER100S-G	EN ISO 16834-A G 62.4 M Mn3NiCrMo
LNM1MoNiVa	0.08	1.7	0.44	1.35	0.25	0.23	0.3	0.08	-	-	-	A5.28	ERT05-G	EN ISO 16834-A G 69.4 M Mn3NiCrMo
LNM1MoNiCr	0.09	1.8	0.80	2.20	-	0.30	0.55	-	-	-	-	A5.28	ERT05-G	EN ISO 16834-A G 89.4 M Mn4Ni2CrMo
LNM1Ni	0.09	1.2	0.65	0.9	-	-	-	-	-	-	-	A5.28	ER80S-N1	EN ISO 14341-A G 46.5 M 3Ni1
LNM1Ni25	0.10	1.1	0.55	2.4	-	-	-	-	-	-	-	A5.28	ER80S-N2	EN ISO 14341-A G 46.6 M 2Ni2
LNM12	0.10	1.12	0.6	-	-	-	0.5	-	-	-	-	A5.28	ER70S-A1	EN ISO 14341-A G 46.3 M 2Mo
LNM19	0.10	1.0	0.5	-	-	1.2	0.5	-	-	-	-	A5.28	ER80S-B2*	ISO 21952-A G CrMo15I
LNM20	0.08	0.9	0.6	-	-	2.5	1.0	-	-	-	-	A5.28	ER90S-B3*	ISO 21952-A G CrMo25I

* Nearest classification

MIG WIRES FOR STAINLESS STEEL

Product name	Chemical composition (typical values) in %											AWS	EN/ISO			
	C	Mn	Si	Cr	Ni	Mo	Nb	N	Cu	P	S			W		
LNM 304L Si	0.020	1.9	0.8	20.0	10.0	0.1	-	-	-	-	-	-	A5.9	ER308LSi	ISO 14343-A	G 19 19 L Si
LNM 304L	0.010	1.6	0.4	20.0	10.0	0.3	-	-	-	-	-	-	A5.9	ER308L	ISO 14343-A	G 19 9 L
LNM 347Si	0.05	1.4	0.7	19.2	9.9	0.1	0.6	-	-	-	-	-	A5.9	ER347Si	ISO 14343-A	G 19 9 NbSi
LNM 316LSi	0.010	1.8	0.8	18.5	12.2	2.5	-	-	-	-	-	-	A5.9	ER316LSi	ISO 14343-A	G 19 12 3 L Si
LNM 316Si	0.05	1.4	0.7	18.6	11.7	2.5	0.7	-	-	-	-	-	A5.9	ER318*	ISO 14343-A	G 19 12 3 NbSi
LNM 4439Mn	0.01	5.2	0.4	19.0	17.0	4.0	-	0.15	-	-	-	-	A5.9	ER316L Mn	ISO 14343-A	G 18 16 5 Ni L*
LNM 4455	0.015	7.0	0.4	20.0	16.0	3.0	-	0.15	-	-	-	-	A5.9	ER316L Mn L	ISO 14343-A	G 20 16 3 Mn L
LNM 4500	0.01	1.7	0.3	20.0	25.0	4.4	-	1.5	-	-	-	-	A5.9	ER385	ISO 14343-A	G 20 25 5 Cu L
LNM 4362	0.01	1.4	0.6	23.0	7.0	0.3	-	0.14	-	-	-	-	No EN or AWS standard			
LNM 4462	0.01	1.3	0.5	23.0	8.5	3.0	-	0.15	-	-	-	-	A5.9	ER209	ISO 14343-A	G 22 9 3 Ni L
LNM 2507	0.03	2.5	1.0	24.0-27.0	8.0-10.5	2.5-4.5	0.03	0.15	0.05	0.03	0.02	-	A5.9	ER2594	ISO 14343-A	G 25 9 4 Ni L
LNM 309Si	0.02	1.8	0.8	23.3	13.8	0.14	-	-	-	-	-	-	A5.9	ER309LSi	ISO 14343-A	G 23 12 L Si
LNM 307	0.07	7.1	0.8	18.6	8.0	-	-	-	-	-	-	-	A5.9	ER307*	ISO 14343-A	G 18 8 Mn
LNM 304H	0.07	1.9	0.4	20.0	9.2	0.1	-	-	-	-	-	-	A5.9	ER308H	ISO 14343-A	G 19 9 H
LNM 309H	0.08	1.8	0.4	23.6	13.2	0.1	-	-	-	-	-	-	A5.9	ER309H	ISO 14343-A	G 19 9 H
LNM 310	0.1	1.7	0.45	26.0	21.0	0.1	-	-	-	-	-	-	A5.9	ER310	ISO 14343-A	G 25 20
LNM 312	0.1	1.8	0.4	30.7	8.9	-	-	-	-	-	-	-	A5.9	ER312	ISO 14343-A	G 29 9

MIG WIRES FOR Ni-BASE ALLOYS

Product name	Chemical composition (typical values) in %											AWS	EN/ISO			
	C	Mn	Si	Ni	Cr	Mo	Cu	Nb	Fe	Al	W			Ti		
LNM NiCr 3127	0.01	1.6	1.0	31.0	27.0	3.5	1.0	-	-	-	-	-	A5.9	ER88	ISO 14343-A	G 27 31 4 Cu L
LNM NiCr 60720	0.02	0.06	0.07	64	21.9	9.0	-	3.5	0.4	-	-	-	A5.14/A5.14M	ERNiCrMo-3	ISO 18274	5 Ni 6625 (NiCr22Mo9Ni)
LNM NiCr 70719	0.03	3.1	0.08	72.5	20.5	-	0.01	2.6	0.8	-	-	-	A5.14/A5.14M	ERNiCr-3	ISO 18274	5 Ni 6082 (NiCr20Mo3Ni)
LNM NiTi	0.02	0.4	0.2	bal.	-	-	-	-	0.06	-	-	31	A5.14/A5.14M	ERNiTi	ISO 18274	5 Ni 2061 (NiTi3)
LNM NiFe	0.05	0.83	0.14	55	-	-	0.4	-	bal.	-	-	-	A5.15	ENiFe-C1	ISO 1071	5 NiFe-C1

MIG WIRES FOR HARDFACING

Product name	Chemical composition (typical values) in %											AWS	EN/ISO	
	C	Mn	Si	Cr	P	S	Ni	Mo						
LNM 420FM	0.5	0.4	0.3	9.0	-	-	-	-	-	-	-	-	EN 14700	5 FE8
LNM 4M	0.7	1.9	0.5	1.0	-	-	-	-	-	-	-	-	EN 14700	5 FE2

* Nearest classification

MIG WIRES FOR CU BASE ALLOYS

Product name	Chemical composition (typical values) in %										AWS	EN/ISO	
	C	Al	Mn	Ni	Si	Ti	Fe	Sn	P	Zn			
LNM CuAl8	bal.	8	0.3	-	-	-	-	-	-	-	-	A5.7	EN ISO 24873 S Cu 6100 [CuAl8]
LNM CuAlBNi6	bal.	9	2.5	5.0	-	4.0	-	-	-	-	-	A5.7	EN ISO 24873 S Cu 6328 [CuAlBNi6]
LNM CuNi30	bal.	-	0.8	31	-	-	-	-	-	-	-	A5.7	EN ISO 24873 S Cu 7158 [CuNi30]
LNM CuSn	bal.	-	0.2	0.1	0.3	-	0.8	-	-	-	-	A5.7	EN ISO 24873 S Cu 1898 [CuSn]
LNM CuSi5	bal.	-	1.0	-	3.0	-	0.1	-	-	0.1	-	A5.7	EN ISO 24873 S Cu 6560 [CuSi5Mn]

MIG WIRES FOR ALUMINIUM

Product name	Chemical composition (typical values) in %													AWS 5.10	EN 573.3	ISO 18273
	Al	Mn	Si	Si	Ti	Fe	Zn	Mg	Cr	Cu	Si+Fe	Zr	V			
SuperGlaze® MIG 1070	min.99.7	max. 0.03	max. 0.2	max. 0.03	max. 0.04	max. 0.03	-	max. 0.05	-	max. 0.04	-	-	max. 0.05	ERT100	EN AW-A199.0Cu	S Al 1070 [Al99.7]
SuperGlaze® MIG 1100	min.99.0	max. 0.05	-	-	max. 0.10	-	-	-	-	0.05-0.20	max. 0.95	-	-	ER2319	EN AW-AiCu6Mn	S Al 1100 [Al99.0Cu]
SuperGlaze® MIG 2319	bal.	0.2-0.4	max. 0.2	0.1-0.2	max. 0.3	max. 0.1	max. 0.02	max. 0.05	-	5.8-6.8	-	-	-	ER4043	EN AW-AiCu6Mn	S Al 2319 [AlCu6MnZrTi]
SuperGlaze® MIG 4043	bal.	max. 0.05	4.5-6.0	max. 0.2	max. 0.6	max. 0.1	max. 0.05	-	max. 0.3	-	-	-	-	ER4047	EN AW-AiSi5	S Al 4043 [AlSi5]
SuperGlaze® MIG 4047	bal.	max. 0.15	11-13	-	max. 0.8	max. 0.2	max. 0.10	-	max. 0.3	-	-	-	-	ER5183	EN AW-AiSi7	S Al 4047 [AlSi7]
SuperGlaze® MIG 5087	bal.	0.7-1.1	max. 0.25	max. 0.15	max. 0.4	max. 0.25	4.5-5.2	0.05-0.25	max. 0.05	-	0.10-0.20	-	-	ER5356	EN AW-AiMg4.5MnZr	S Al 5087 [AlMg4.5MnZr]
SuperGlaze® MIG 5183	bal.	0.5-1.0	max. 0.4	max. 0.15	max. 0.4	max. 0.25	4.3-5.2	0.05-0.25	max. 0.1	-	-	-	-	ER5356	EN AW-AiMg4.5Mn	S Al 5183 [AlMg4.5Mn0.7Al]
SuperGlaze® MIG 5356	bal.	0.05-0.2	max. 0.25	0.06-0.2	max. 0.4	max. 0.1	4.5-5.5	0.05-0.20	max. 0.1	-	-	-	-	ER5356	EN AW-AiMg5	S Al 5356 [AlMg5CrAl]
SuperGlaze® MIG 5386 TM™	bal.	0.05-0.2	max. 0.25	0.06-0.2	max. 0.4	max. 0.1	4.5-5.5	0.05-0.20	max. 0.1	-	-	-	-	ER5356	EN AW-AiMg5	S Al 5356 [AlMg5CrAl]
SuperGlaze® MIG 5556	bal.	0.5-1.0	max. 0.25	0.05-0.2	max. 0.4	max. 0.25	4.7-5.5	0.05-0.20	max. 0.1	-	-	-	-	ER5556	EN AW-AiMg5Mn	S Al 5556 [AlMg5MnTi]
SuperGlaze® MIG 5556A	bal.	0.6-1.0	max. 0.25	0.05-0.2	max. 0.4	max. 0.2	5.0-5.5	0.05-0.20	max. 0.1	-	-	-	-	ER5556	EN AW-AiMg5Mn	S Al 5556A [AlMg5Mn]
SuperGlaze® MIG 5754	bal.	max. 0.5	max. 0.4	max. 0.15	max. 0.4	max. 0.2	2.6-3.6	max. 0.3	max. 0.1	-	-	-	-	EN AW AlMg3	EN AW AlMg3	S Al 5754 [AlMg3]

All information in this data sheet is accurate to the best of our knowledge at the time of printing. Please refer to www.lincolnelectric.eu for any updated information. Fumes: Safety Data Sheets (SDS) are available on our website.

TIG RODS FOR MILD STEEL

Product name	Chemical composition [typical values] in %				AWS	EM/ISO
	C	Mn	Si			
LNT 25	0.08	1.1	0.6	A5.18/A5.18M	ER70S-3	EM/ISO 636-A W 42.5 W2Si
LNT 26	0.10	1.5	0.9	A5.18/A5.18M	ER70S-6	EM/ISO 636-A W 42.5 W3Si

TIG RODS FOR LOW ALLOY STEEL

Product name	Chemical composition [typical values] in %											AWS	EM/ISO	
	Chemical composition [typical values] in %													
	C	Mn	Si	Ni	Cu	Cr	Mo	V	Nb	N				
LNT 28	0.10	1.4	0.75	0.8	0.3	-	-	-	-	-	-	A5.28	ER80S-G	
LNT Ni1	0.10	1.2	0.6	0.9	-	-	-	-	-	-	-	A5.28	ER80S-Ni1	W 42.6 W3Ni1
LNT NiMn1	0.08	1.7	0.7	0.4	-	0.35	-	-	-	-	-	A5.28	ER100S-G	W Mn3 Ni1 Mo
LNT Ni2.5	0.10	1.1	0.55	2.4	-	-	-	-	-	-	-	A5.28	ER80S-Ni2	W 2Ni2
LNT 12	0.10	1.2	0.6	-	-	0.5	-	-	-	-	-	A5.28	ER70S-A1	W Mo5i
LNT 19	0.10	1.0	0.6	-	1.2	0.5	-	-	-	-	-	A5.28	ER80S-B2*	W CrMo15i
LNT 20	0.08	1.0	0.6	-	2.5	1.0	-	-	-	-	-	A5.28	ER90S-BB*	W CrMo25i
LNT 502	0.09	0.6	0.3	-	5.7	0.6	-	-	-	-	-	A5.28	ER80S-B6	W CrMo55i
LNT 9Cr(p9j)	0.11	0.8	0.25	0.5	0.06	8.9	1.0	0.2	0.06	-	-	A5.28	ER90S-B9	W CrMo91

TIG RODS FOR STAINLESS STEEL

Product name	Chemical composition [typical values] in %													AWS	EM/ISO
	Chemical composition [typical values] in %														
	C	Mn	Si	Cr	Ni	Mo	Nb	N	Cu	P	S	W			
LNT 304LSi	0.02	2.0	0.8	20.0	10.0	0.1	-	-	-	-	-	-	A5.9	ER308LSi	ISO 14343-A W 19.9 L Si
LNT 304L	0.01	1.7	0.4	20.0	10.0	0.1	-	-	-	-	-	-	A5.9	ER308L	ISO 14343-A W 19.9 L
LNT 347Si	0.05	1.4	0.7	19.5	9.5	0.01	0.6	-	-	-	-	-	A5.9	ER347Si	ISO 14343-A W 19.9 Nb5i
LNT 316L	0.01	1.5	0.5	18.5	12	2.7	-	-	-	-	-	-	A5.9	ER316L	ISO 14343-A W 19.12.3 L
LNT 316LSi	0.08	1.9	0.8	18.5	12.0	2.7	-	-	-	-	-	-	A5.9	ER316LSi	ISO 14343-A W 19.12.3 L Si
LNT 318Si	0.05	1.4	0.7	18.7	11.7	2.5	0.7	-	-	-	-	-	A5.9	ER318*	ISO 14343-A W 19.12.3 Nb5i
LNT 4439Mn	0.02	7.0	0.4	18.0	16.0	4.5	-	0.15	-	-	-	-	A5.9	ER318*	ISO 14343-A W 18.16.5 Ni*
LNT 4500	0.01	1.7	0.4	20.0	25.0	4.5	-	-	1.5	-	-	-	A5.9	ER885	ISO 14343-A W 20.25.5 Cu L
LNT 4462	0.01	1.6	0.5	22.5	8.5	3.0	-	0.15	-	-	-	-	A5.9	ERZ209	ISO 14343-A W 22.9.3 Ni L
LNT Zeron®100X	0.02	0.6	0.23	25.0	9.3	3.6	-	0.22	0.6	-	0.6	-	A5.9	ERZ594	ISO 14343-A W 25.9.4 Ni L
LNT 309LSi	0.02	2.0	0.8	23.5	18.0	0.1	-	-	-	-	-	-	A5.9	ER309LSi	ISO 14343-A W 23.12.L Si
LNT 309L	0.01	1.65	0.5	24.0	18.0	0.1	-	-	-	-	-	-	A5.9	ER309L	ISO 14343-A W 23.12 L
LNT 309LHF	0.02	2.0	0.35	24	18	0.1	-	-	-	-	-	-	A5.9	ER309L	ISO 14343-A W 23.12 L
LNT 307	0.07	7.0	0.8	18.6	8.0	-	-	-	-	-	-	-	A5.9	ER307*	ISO 14343-A W 18.8 Mn
LNT 304H	0.07	1.9	0.4	20.0	9.2	0.1	-	-	-	-	-	-	A5.9	ER308H	ISO 14343-A W 19.9 H
LNT 310	0.1	1.7	0.5	26.0	21	0.1	-	-	-	-	-	-	A5.9	ER310	ISO 14343-A W 25.20

All information in this data sheet is accurate to the best of our knowledge at the time of printing. Please refer to www.lincolnelectric.eu for any updated information. Fumes: Safety Data Sheets (SDS) are available on our website.

TIG RODS FOR NI BASE ALLOYS

Product name	Chemical composition (typical values) in %											AWS	EN/ISO			
	C	Mn	Si	Ni	Cr	Mo	Cu	Nb	Fe	Al	W			Ti		
LINT NiCro 60/20	0.03	0.1	0.1	bal.	22.0	9.0	-	3.5	0.4	-	-	-	A5:14/A5:14M	ERNiCrMo-3	ISO 18274	S Ni 6625 (NiCr22Mo9Ni)
LINT NiCro 70/19	0.03	3.0	0.2	bal.	20.0	-	0.1	2.5	1.0	-	-	-	A5:14/A5:14M	ERNiCr-3	ISO 18274	S Ni 6082 (NiCr20Mn3Nb)
LINT NiCroMo 59/23	0.015	0.5	0.06	59	23	16	-	-	1.5	0.4	-	-	A5:14/A5:14M	ERNiCrMo-13	ISO 18274	S Ni 6059 (NiCr23Mo16)
LINT NiCu 70/30	0.06	3.5	0.5	65	-	-	30	-	11	-	2.0	-	A5:14/A5:14M	ERNiCu-7	ISO 18274	S Ni 4060 (NiCr30MnTi)
LINT NiTi	0.03	0.5	0.4	bal.	-	-	-	-	0.06	-	2.8	-	A5:14/A5:14M	ERNiTi	ISO 18274	S Ni 2061 (NiTi3)

TIG RODS FOR CU BASE ALLOYS

Product name	Chemical composition (typical values) in %											AWS	EN/ISO			
	C	Al	Mn	Ni	Si	Ti	Fe	Sn	P	Zn						
LINT CuM80	bal.	-	0.75	30	0.05	0.35	0.5	-	-	-	-	-	A5:7	ERCuNi	EN ISO 24373	S Cu 7158 (CuNi30)
LINT CuSn6	bal.	-	-	-	-	-	-	6	0.2	-	-	-	A5:7	ERCuSn-A	EN ISO 24373	S Cu 5180 (CuSn6P)
LINT CuSiB	bal.	-	1.0	-	3.0	-	-	01	-	-	0.1	-	A5:7	ERCuSi-A	EN ISO 24373	S Cu 6560 (CuSi3MnTi)

All information in this data sheet is accurate to the best of our knowledge at the time of printing. Please refer to www.lincolnelectric.eu for any updated information. Fumes: Safety Data Sheets (SDS) are available on our website.

TIG RODS FOR ALUMINIUM

Product name	Chemical composition (typical values) in %													AWS 5:10	EN 573.3	ISO 18273
	Al	Mn	Si	Ti	Fe	Zn	Mg	Cr	Cu	Si+Fe	Zr	V				
SuperGlaze® TIG 1070	min.99.7	max.0.03	max.0.2	max.0.03	max.0.25	max.0.04	max.0.03	-	max.0.04	-	-	max.0.05	RT100	EN AW-Al99.0Cu	S Al 1070 [Al99.7]	
SuperGlaze® TIG 1100	min.99.0	max.0.05	-	-	max.0.8	max.0.10	-	-	0.05-0.20	max.0.95	-	-	R4043	EN AW-AlSi5	S Al 1100 [Al99.0Cu]	
SuperGlaze® TIG 4043	bal.	max.0.05	4.5-6.0	-	max.0.8	max.0.1	max.0.05	-	max.0.3	-	-	-	R4047	EN AW-AlSi2	S Al 4043 [AlSi5]	
SuperGlaze® TIG 4047	bal.	max.0.15	11-13	-	max.0.8	max.0.2	max.0.10	-	max.0.3	-	-	-	-	EN AW-AlSi2	S Al 4047 [AlSi2]	
SuperGlaze® TIG 5087	bal.	0.7-1.1	max.0.25	max.0.15	max.0.4	max.0.25	4.5-5.2	0.05-0.25	max.0.05	-	0.10-0.20	-	-	EN AW-AlMg4.5MnZr	S Al 5087 [AlMg4.5MnZr]	
SuperGlaze® TIG 5183	bal.	0.5-1.0	max.0.4	max.0.15	max.0.4	max.0.25	4.3-5.2	0.05-0.25	max.0.1	-	-	-	R5183	EN AW-AlMg4.5Mn	S Al 5183 [AlMg4.5Mn0.7(Al)]	
SuperGlaze® TIG 5356	bal.	0.05-0.2	max.0.25	0.06-0.2	max.0.4	max.0.1	4.5-5.5	0.05-0.20	max.0.1	-	-	-	R5356	EN AW-AlMg5	S Al 5356 [AlMg5Cr(Al)]	
SuperGlaze® TIG 5556	bal.	0.5-1.0	max.0.25	0.05-0.2	max.0.4	max.0.25	4.7-5.5	0.05-0.20	max.0.1	-	-	-	R5556	EN AW-AlMg5	S Al 5556 [AlMg5MnTi]	
SuperGlaze® TIG 5754	bal.	max.0.5	max.0.4	max.0.15	max.0.4	max.0.2	2.6-3.6	max.0.3	max.0.1	-	-	-	R5554	EN AW-AlMg3	S Al 5754 [AlMg3]	

AUTOGENOUS WIRES

Product name	Chemical composition (typical values) in %										AWS		DIM/ISO
	C	Mn	Si	Cr	P	S	Ni	Mo	Cu				
LNG I	0.07	0.4	0.07	-	0.01	0.01	-	-	-	A5.2	R45*	EN 12536	O I
LNG II	0.1	1.1	0.15	-	0.01	0.01	-	-	-	A5.2	R60*	EN 12536	O II
LNG IV	0.09	1.0	0.19	-	0.010	0.010	-	0.5	-	A5.2	R65*	EN 12536	O IV

All information in this data sheet is accurate to the best of our knowledge at the time of printing. Please refer to www.lincolnelectric.eu for any updated information. Fumes: Safety Data Sheets (SDS) are available on our website.

GAS SHIELDED FLUX-CORED WIRES (MILD AND LOW ALLOY STEEL)

Product name	Chemical composition (typical values) in %											AWS	EN/ISO		
	Gas	C	Mn	Si	P	S	Ni	Cu	Mo	Cr					
Outersheild* 70-H	C1	0.06	1.30	0.50	0.015	0.010	-	-	-	-	-	A5.20/A5.20M	E70T1C-H4 / E70T-1M-H4	EN ISO 17632-A	T 46 0 R C3 H5 / T 46 0 R M3 H5
Outersheild* 71E-H	M21	0.06	1.70	0.35	0.015	0.010	-	-	-	-	-	A5.20/A5.20M	E70T1C-H4 / E70T-1M-H4	EN ISO 17632-A	T 46 0 R C3 H5 / T 46 0 R M3 H5
Outersheild* 71M-H	C1	0.05	1.3	0.6	0.015	0.010	-	-	-	-	-	A5.20/A5.20M	E71T-1C-H4	EN ISO 17632-A	T 42 0 P C1 H5
Outersheild* 71MS-H	M21	0.05	1.47	0.5	0.015	0.009	-	-	-	-	-	A5.20/A5.20M	E71T-19C-H4 / E71T-19M-H4	EN ISO 17632-A	T 46 3 P C1 H5 / T 46 2 P M2 H5
Outersheild* 71S-H	C1	0.05	1.5	0.55	0.012	0.010	-	-	-	-	-	A5.20/A5.20M	E71T-9C-JH4	EN ISO 17632-A	T 46 4 P C2 H5
Outersheild* MC700	M21	0.06	1.5	0.6	0.012	0.010	-	-	-	-	-	A5.20/A5.20M	E71T-9C-JH4 / E71T-5M-JH4	EN ISO 17632-A	T 42 4 B C2 H5 / T 42 4 B M2 H5
Outersheild* MC710-H	M21	0.05	1.35	0.6	0.015	0.023	-	-	-	-	-	A5.18/A5.18M	E70C-6M H8	EN ISO 17632-A	T 46 2 M M2 H10
Outersheild* MC710C-H	C1	0.05	1.35	0.6	0.015	0.023	-	-	-	-	-	A5.18/A5.18M	E70C-6M H4	EN ISO 17632-A	T 46 3 M C2 H5
Outersheild* MC715-H	M21	0.04	1.5	0.4	0.012	0.02	-	-	-	-	-	A5.28	E80C-N1M H4	EN ISO 17632-A	T 46 5 N1 M1 M2 H5
Outersheild* MC420N-H*	M21	0.03	0.6	0.45	0.007	0.023	2.9	-	-	0.03	-	A5.28/A5.28M	E70C-6M H4	EN ISO 17632-A	T 46 4 M M2 H5
Outersheild* MC555CT-H	C1	0.05	1.4	0.2	0.013	0.010	0.95	-	-	-	-	A5.29/A5.29M	E80C-VZ-H4	EN ISO 17632-B	T 55 4 T15-0MA-NCT-UH5
Outersheild* 81Ni-H	M21	0.05	1.4	0.2	0.013	0.010	0.95	-	-	-	-	A5.29/A5.29M	E81T-N1C-JH4 ³⁾	EN ISO 17632-A	T 50 4 T1P C2 H5 ⁴⁾
Outersheild* 81K2-H	M21	0.04	1.4	0.2	0.012	0.010	1.4	-	-	-	-	A5.29/A5.29M	E81T-N1M-JH4 ³⁾	EN ISO 17632-A	T 50 5 N1 P M2 H5 ⁴⁾
Outersheild* 500CT-H	M21	0.06	1.3	0.3	0.012	0.010	1.4	-	-	-	-	A5.29/A5.29M	E81T-K2M-JH4 ³⁾	EN ISO 17632-A	T 50 6 1.5N1 P M2 H5 ⁴⁾
Outersheild* 555CT-H	M21	0.03	1.1	0.4	0.015	0.010	0.6	0.55	-	-	-	A5.29/A5.29M	E81T-GM-H4	EN ISO 17632-A	T 50 5 Z P M2 H5
Outersheild* 91Ni-H	M21	0.05	1.4	0.2	0.013	0.010	0.95	-	-	-	-	A5.29/A5.29M	E81T-V2M-JH4	T 55 5 T15-0MA-NCT-UH5	
Outersheild* 91K2-HSR	M21	0.05	1.4	0.2	0.013	0.010	1.4	-	-	-	-	A5.29/A5.29M	E91T-GM-H4	ISO 18276-A	T 55 4 1.5N1Mo P M2 H5
Outersheild* 690-H	M21	0.06	1.5	0.2	0.015	0.010	2.0	-	-	-	-	A5.29/A5.29M	E11T1-K3M-JH4	ISO 18276-A	T 69 4 Z P M2 H5
Outersheild* 690-HSR	M21	0.06	2.0	0.3	0.013	0.010	0.95	-	-	-	-	A5.29/A5.29M	E11T1-K3M-JH4	ISO 18276-A	T 69 4 Z P M2 H5 T
Outersheild* 10Ni-HSR	M21	0.065	0.8	0.2	0.014	0.010	-	-	-	-	-	A5.29/A5.29M	E10T1-G-H4	ISO 17634-A	T Mol. P M2 H5
Outersheild* 19-H	M21	0.07	0.74	0.24	0.013	0.010	-	-	-	-	-	A5.29/A5.29M	E 81T1-B2M-H4	ISO 17634-A	T CrMo1 P M2 H5
Outersheild* 20-H	M21	0.07	0.75	0.21	0.013	0.008	-	-	-	-	-	A5.29/A5.29M	E 91T1-B3M-H4	ISO 17634-A	T CrMo2 P M2 H5

* as mentioned classifications are an indication of the weld metal properties in the as welded condition. However, the Outersheild MC420N-H is designed to be used only in the normalized condition. As neither AWS nor EN has included weld metal properties in the normalized condition, the wire cannot be classified for the condition it is designed for.

¹⁾ Ø 1.2 and 1.6 mm

²⁾ Ø 2.0 and 2.4 mm

³⁾ all diameters

⁴⁾ only diameter 1.2 mm

SELF-SHIELDED FLUX-CORED WIRES

Product name	Chemical composition (typical values) in %											AWS	EN/ISO		
	C	Mn	Si	P	S	Ni	Cr	Al	V	Mo					
Innershield [®] NR-162	0.30	0.99	0.24	0.013	0.007	-	-	1.63	-	-	-	A5.20/A5.20M	E7T1-14	EN ISO 17632-A	T 42 Z Z N 5
Innershield [®] NR-203 NiC	0.06	0.83	0.05	0.004	0.003	0.57	0.08	0.73	<0.1	<0.1	-	A5.29/A5.29M	E6T18-K6	EN ISO 17632-A	T 42 4 1Ni Y N 1 H10
Innershield [®] NR-203Ni1	0.08	1.1	0.27	0.008	0.003	0.9	-	0.85	-	-	-	A5.29/A5.29M	E7T18-Ni1	EN ISO 17632-A	T 42 Z Z N 1 H10
Innershield [®] NR-211-MP	0.21	0.65	0.25	0.010	0.003	-	-	1.30	-	-	-	A5.20/A5.20M	E7T1-11	EN ISO 17632-A	T 42 2 Y N 2 H10
Innershield [®] NR-232	0.18	0.65	0.27	0.006	0.004	-	-	0.55	-	-	-	A5.20/A5.20M	E7T1-8	EN ISO 17632-A	T 42 3 Y N 2 H10
Innershield [®] NR-233	0.16	0.65	0.21	0.010	0.003	-	-	0.60	-	-	-	A5.20/A5.20M	E7T1-8	EN ISO 17632-A	T 42 3 Y N 2 H10
Innershield [®] NR-207-H	0.07	0.9	0.20	0.005	0.003	0.85	-	1.0	-	-	-	A5.29/A5.29M	E7T18-K6	EN ISO 17632-A	T 42 0 W N 3 H15
Innershield [®] NR-208-H	0.05	1.65	0.25	0.007	<0.003	0.8	-	0.85	-	-	-	A5.29/A5.29M	E9T18-G	EN ISO 17632-A	T 42 6 1Ni Y N 2 H10
Innershield [®] NR-305	0.09	0.9	0.20	0.007	0.008	-	-	0.80	-	-	-	A5.20/A5.20M	E70T-6	EN ISO 17632-A	T 46 Z V N 3
Innershield [®] NR-311	0.27	0.40	0.08	0.007	0.005	-	-	1.5	-	-	-	A5.20/A5.20M	E70T-7	EN ISO 17632-A	T 46 Z V N 3
Innershield [®] NR-400	0.06	0.74	0.17	0.004	0.002	0.75	0.13	0.74	-	-	-	A5.29/A5.29M	E7T18-K6	EN ISO 17632-A	T 46 Z V N 3
Innershield [®] NS-3M	0.23	0.45	0.25	0.006	0.006	-	-	1.40	-	-	-	A5.20/A5.20M	E70T-4	EN ISO 17632-A	T 46 Z V N 3

¹ also meets: E6T18-Ni2

* Chemistries of the welds will change with different heats of steel.

GAS SHIELDED FLUX-CORED WIRES (STAINLESS STEEL)

Product name	Chemical composition (typical values) in %											AWS	EN/ISO		
	Gas	C	Mn	Si	Cr	Ni	Nb	Mo	N						
Cor-A-Rosta [®] 304L	M21/C1	0.03	1.3	0.7	19.5	10.0	-	-	-	-	-	A5.22	E308LT0-1/4	ISO 17633-A	T 19 9 L R C/M 3
Cor-A-Rosta [®] P304L	M21/C1	0.03	1.3	0.7	19.5	10.0	-	-	-	-	-	A5.22	E308LT1-1/4	ISO 17633-A	T 19 9 L P C/M 2
Cor-A-Rosta [®] 347	M21	0.05	1.4	0.6	19.5	10.0	0.5	-	-	-	-	A5.22	E347T1-1/4	ISO 17633-A	T 19 9 Nb R M 3
Cor-A-Rosta [®] 316L	M21/C1	0.03	1.3	0.5	19.0	12.0	-	2.7	-	-	-	A5.22	E316LT0-1/4	ISO 17633-A	T 19 12 3 L R C/M 3
Cor-A-Rosta [®] P316L	M21/C1	0.03	1.3	0.5	19.0	12.0	-	2.7	-	-	-	A5.22	E316LT1-1/4	ISO 17633-A	T 19 12 3 L P C/M 2
Cor-A-Rosta [®] 309L	M21/C1	0.03	1.3	0.6	24.0	12.5	-	-	-	-	-	A5.22	E309LT0-1/4	ISO 17633-A	T 23 12 L R C/M 3
Cor-A-Rosta [®] P309L	M21/C1	0.04	1.3	0.6	24.0	12.5	-	-	-	-	-	A5.22	E309LT1-1/4	ISO 17633-A	T 23 12 L P C/M 2
Cor-A-Rosta [®] 309MoL	M21/C1	0.03	1.8	0.7	23.0	12.8	-	2.3	-	-	-	A5.22	E309LMo10-1/4	ISO 17633-A	T 23 12 2 L R C/M 3
Cor-A-Rosta [®] P309MoL	M21/C1	0.03	1.8	0.6	22.7	12.5	-	2.3	-	-	-	A5.22	E309LMo11-1/4	ISO 17633-A	T 23 12 2 L P C/M 2
Cor-A-Rosta [®] 4462	M21	0.03	1.2	0.7	23.0	9.2	-	3.1	0.12	-	-	A5.22	E2209T0-4	ISO 17633-A	T 22 9 3 N L R M 3
Cor-A-Rosta [®] P4462	M21	0.03	1.2	0.7	23.0	9.2	-	3.1	0.12	-	-	A5.22	E2209T1-4	ISO 17633-A	T 22 9 3 N L P C/M 2

SELF SHIELDING FLUX CORED WIRES FOR HARDFACING APPLICATIONS

Product name	Chemical composition (typical values) in %										EN/ISO	
	C	Mn	Si	Cr	Mo	Al	W	Ni				
Lincore 33	0.15	2.0	0.7	2.0	-	1.6	-	-	-	-	EN 14700	T Fe 1
Lincore 40-0	0.2	1.5	0.7	3.5	0.4	1.8	-	-	-	-	EN 14700	T Fe 1
Lincore 50	2.2	1.2	1.0	11.0	0.5	0.6	-	-	-	-	EN 14700	T Fe 8
Lincore 55	0.45	1.4	0.55	5.3	0.8	1.4	-	-	-	-		
Lincore 60-0	4.2	1.6	1.3	25.4	-	0.6	-	-	-	-		
Lincore T8D	0.65	1.5	0.8	7.0	1.4	1.8	1.6	-	-	-	EN 14700	T Fe 8
Lincore 15CrMn	0.4	15.0	0.25	16.0	-	-	-	-	-	-	EN 14700	T Fe 9
Lincore 420 ø1.6	0.5	1.7	1.7	11	-	-	-	-	-	-		
Lincore ø2.0	0.5	1.4	0.7	11	-	-	-	-	-	-		
Lincore M	0.6	8.0	0.4	4.9	-	-	-	-	-	0.5	EN 14700	T Fe 9

All information in this data sheet is accurate to the best of our knowledge at the time of printing. Please refer to www.lincolnelectric.eu for any updated information. Fumes: Safety Data Sheets (SDS) are available on our website.

SAW WIRES FOR MILD STEEL

Product name	Chemical composition (typical values) in %					AWS	EN/ISO
	C	Mn	Si	P	S		
L-60	0.09	0.5	0.06	-	-	A5.17 E112	ISO 14171-A S1
LNS 135	0.1	1.0	0.10	-	-	A5.17 EM12	ISO 14171-A S2
L-61	0.1	1.0	0.25	-	-	A5.17 EM12K	ISO 14171-A S2S1
L-50M (LNS 133U)	0.1	1.6	0.25	-	-	A5.17 EH12K	ISO 14171-A S3S1

SAW WIRES FOR LOW ALLOY STEEL

Product name	Chemical composition (typical values) in %											AWS	EN/ISO
	C	Mn	Si	P	S	Cr	Ti	Ni	Mo	Cu			
L-70	0.10	0.9	0.10	-	-	-	-	-	-	0.5	-	A5.23/A5.23M EA1	ISO 14171-A S2 Mo
LNS 140A	0.10	1.0	0.10	-	-	-	-	-	-	0.5	-	A5.23/A5.23M EA2	ISO 14171-A S2 Mo
LNS 133TB	0.08	1.55	0.25	-	-	0.15	-	-	-	-	-	A5.23/A5.23M EG	ISO 14171-A SZ
LNS 140TB (LA 81)	0.06	1.1	0.20	-	-	0.13	-	-	-	0.5	-	A5.23/A5.23M EA2TiB	ISO 14171-A S2MoTiB
LNS 150 (LA 92)	0.13	0.8	0.15	<0.010	-	1.2	-	-	-	0.5	-	A5.23/A5.23M EB2	ISO 21952-A S Cr Mo1
LNS 151 (LA 93)	0.10	0.6	0.12	<0.010	-	2.5	-	-	-	1.0	-	A5.23/A5.23M EB3	ISO 21952-A S Cr Mo2
LNS 160	0.10	1.1	0.15	-	-	-	-	-	-	-	1.0	A5.23/A5.23M ENi1	ISO 14171-A S2 Ni1*
LNS 162	0.10	1.1	0.15	-	-	-	-	-	-	-	2.2	A5.23/A5.23M ENi2	ISO 14171-A S2 Ni2*
LNS 163	0.11	1.0	0.25	0.2	0.2	0.2	0.7	-	-	0.5	-	A5.23/A5.23M EG	ISO 14171-A S2 Ni1Cu
LNS 164 (LA 84)	0.10	1.75	0.10	-	-	-	-	-	-	0.9	0.5	A5.23/A5.23M EF3	ISO 14171-A S3 NiMo
LNS 165 (LA 85)	0.08	1.4	0.20	-	-	-	-	-	-	1.0	0.2	A5.23/A5.23M ENi5	ISO 14171-A SZ
LNS 168	0.10	1.6	0.15	-	-	0.7	-	-	-	2.3	0.6	-	ISO 26304-A S3 Ni2.5CrMo
LNS 175	0.08	1.0	0.10	-	-	-	-	-	-	3.5	-	A5.23/A5.23M ENi3	ISO 14171-A S2Ni3
LNS T55 **	0.06	1.5	0.60	<0.020	<0.010	-	-	-	-	-	-	A5.17/A5.17M EC1 H4	ISO 14171-A TZ

* for deviations consult corresponding data sheet

** flux cored wires

SAW WIRES FOR STAINLESS STEEL

Product name	Chemical composition (typical values) in %											AWS	EN/ISO	
	C	Mn	Si	Cr	Ni	Mo	Nb	N	Others	Mat.Nr.				
LNS 304L	0.015	1.8	0.4	20	10	0.1	-	-	-	1.4316	A5.9/A5.9M	ER308L	ISO 14343-A	S 19 9 L
LNS 304H	0.05	1.2	0.6	20.1	10.5	-	-	-	-	1.4948	A5.9/A5.9M	ER308H	ISO 14343-A	S 19 9 H
LNS 307	0.07	7.0	0.6	19.0	8.9	-	-	-	-	1.4370	A5.9/A5.9M	ER307	ISO 14343-A	S 18 8 Mn
LNS 309L	0.01	1.8	0.4	23.4	13.8	0.07	-	-	-	1.4332	A5.9/A5.9M	ER309L	ISO 14343-A	S 23 12 L
LNS 316L	0.015	1.75	0.4	18.5	12	2.75	-	-	-	1.4430	A5.9/A5.9M	ER316L	ISO 14343-A	S 19 12 3 L
LNS 318	0.04	1.7	0.4	19.5	11.3	2.6	0.5	-	-	1.4576	A5.9/A5.9M	ER318	ISO 14343-A	S 19 12 3 Nb
LNS 347	0.03	1.6	0.4	19.5	9.7	0.1	0.6	-	-	1.4451	A5.9/A5.9M	ER347	ISO 14343-A	S 19 9 Nb
LNS 4455	0.01	7.0	0.4	20	16	2.7	-	0.16	-	1.4455	-	-	ISO 14343-A	S 20 16 3 Mn L
LNS 4462	0.015	1.6	0.5	23	8.6	3.1	-	0.16	-	1.4462	A5.9/A5.9M	ER2209	ISO 14343-A	S 22 9 3 N L
LNS 4500	0.01	1.8	0.3	20	25.2	4.6	-	-	Cu=1.5	1.4539	A5.9/A5.9M	ER385	ISO 14343-A	S 20 25 5 Cu L
LNS Zeron® 100X	0.02	0.7	0.3	25	9.3	3.7	-	0.23	Cu=0.6	1.4410	A5.9/A5.9M	ER2594	ISO 14343-A	S 25 9 4 N L
									W=0.6					

SAW WIRES FOR NICKEL ALLOYS

Product name	Chemical composition (typical values) in %											AWS	EN/ISO	
	C	Mn	Si	Cr	Ni	Mo	Nb	N	Others	W.Nr.				
LNS NiCro 60/20	0.05	0.02	0.1	22	65	8.7	3.7	3.7	Fe=0.1	2.4831	A5.14/A5.14M	ERNiCrMo-3	ISO 18274	S Ni 6625
LNS NiCro 70/19	0.03	3.1	0.08	20.5	72.5	-	2.6	-	Fe=0.8	-	A5.14/A5.14M	ERNiCr-3	ISO 18274	S Ni 6082
LNS NiCroMo 60/16	0.006	0.5	0.04	16.0	58	16	-	-	W=3.6	2.4886	A5.14/A5.14M	ERNiCrMo-4	ISO 18274	S Ni 6276

PIPELINER RANGE

Product name	Chemical composition (typical values) in %											AWS	EN/ISO		
	C	Mn	Si	Ni	Mo	P	S	Cr	Ti	Al					
PIPELINER® 6P+	0.11	0.95	0.18	-	-	0.009	0.009	-	-	-	-	-	A5.1	ISO 2560-A	E 42 3 C 25
PIPELINER® 7P+	0.15	0.6	0.1	0.85	0.1	0.015	0.015	-	-	-	-	-	A5.1	ISO 2560-A	E 42 3 Z C 25
PIPELINER® 8P+	0.17	0.7	0.25	0.8	0.2	0.01	0.01	-	-	-	-	-	A5.5	ISO 2560-A	E 46 4 1Ni C 25
PIPELINER® 16P	0.06	1.3	0.5	-	-	0.013	0.009	-	-	-	-	-	A5.1	ISO 2560-A	E 42 3 B 12 H5
PIPELINER® 18P	0.05	1.5	0.5	0.95	-	0.010	0.009	-	-	-	-	-	A5.5	ISO 2560-A	E 50 6 MnNiB 32 H5
PIPELINER® LH-D80	0.05	1.15	0.45	-	-	0.010	0.010	-	-	-	-	-	A5.5	ISO 2560-A	E 46 4 Z B 45 H5
PIPELINER® LH-D90	0.05	1.3	0.50	0.925	0.2	0.009	0.009	0.05	-	-	-	-	A5.5	ISO 18275	E 55 4 ZB 45 H5
PIPELINER® LH-D100	0.05	1.55	0.45	0.9	0.45	0.009	0.009	-	-	-	-	-	A5.5	ISO 10045-P2 HAR	
PIPELINER® 70S-G	0.07	1.25	0.55	-	-	0.010	0.020	-	-	-	-	-	A5.18	ER70S-G	
PIPELINER® 80S-G	0.09	1.55	0.61	-	-	0.012	0.007	-	-	-	-	-	A5.28	ER80S-G	G 38 3 M G2Si / G 38 3 C G2Si
PIPELINER® 80Ni	0.07	1.95	0.7	0.9	<0.01	0.11	0.10	0.08	<0.01	-	-	-	A5.28	ISO 14341-A	G 50 3 M G4Si1
PIPELINER® G70M-E	0.06	1.5	0.20	0.95	0.15	0.013	0.010	-	-	-	-	-	A5.29	ISO 14341-A	G 3Ni1
PIPELINER® G60M-E	0.06	1.5	0.30	0.9	0.40	0.013	0.010	-	-	-	-	-	A5.29	EN 758	T 50 5 Z P M 2 H5
PIPELINER® G90M-E	0.06	1.5	0.20	2.0	0.50	0.015	0.010	-	-	-	-	-	A5.29	ISO 18276-A	T 55 4 Z P M 2 H5
PIPELINER® NR*-Z07+	0.05	1.22	0.25	0.82	-	0.010	0.010	-	-	-	-	-	A5.29	ISO 18276-A	T 69 4 Z P M 2 H5
PIPELINER® NR*-Z08XP	0.02	2.15	0.12	0.75	0.02	0.005	0.002	0.04	-	1.1	-	-	A5.29	E 7118-K6	
													A5.29	E 8118-G5	

Covered electrodes	TIG rods	MIG/MAG wires	Gas shielded flux-cored wires	Self shielded flux-cored wires	SAW wires / flux
1 Fleetweld 5P+				Innershield NR204-H, NR207-H	1
2 Supra				Innershield NR204-H, NR207-H	2
3 Panta					3
4 Pantafix					4
5 Omnia				Innershield NR-211-MIP	5
6 Omnia 46				Innershield NR-232	6
7 Cumulo					7
8 Universalis					8
9 Ferrod 165A			Outershield 70-H	Innershield NR-232	9
10 Ferrod 135T			Outershield 71E-H	Innershield NR-311	10
11 Ferrod 160T			Outershield 71M-H	Innershield NS-3M	11
12 Gonia 180		LNM 25	Outershield MC700		12
13 Baso 48SP			Outershield MC710-H		13
14 Baso 51P	LNT 25, LNT 26	SupraMIG	Outershield 71C		14
15 Baso 100		SupraMIG Ultra	Outershield MC715-H		15
16 Baso 120			Outershield MC460VD-H	Innershield NR-203Ni	16
17 Baso G			Outershield T55-H	Innershield NR-203NiC	17
18 Baso 26V				Innershield NR-204-H	18
19 Conarc 48				Innershield NR-207-H	19
20 Conarc 49				Innershield NR-208-H	20
21 Conarc 49C				Innershield NR-400	21
22 Conarc 51					22
23 Conarc 52					23
24 LincIn 7018-1					L-60, L-61, LNS 135 combined with flux
25 Conarc U150					761, 780, 781, 782, 960, 980
26 Conarc V180					
27 Kardo				Innershield NR-203NiC	

All information in this data sheet is accurate to the best of our knowledge at the time of printing. Please refer to www.lincolnelectric.eu for any updated information. Fumes: Safety Data Sheets (SDS) are available on our website.

CORRESPONDING WELDING CONSUMABLES [Low alloy steel]

Covered electrodes	TIG rods	MIG/MAG wires	Gas shielded flux-cored wires	Self shielded flux-cored wires	SAW wires / flux
1 Shield Arc HYP+	LNT 25, LNT 26	LNM 25	Outershield 71E-H	Innershield NR208-H	LNS 135, LNS 140A (L-70) with flux 780, 860, P230
2 Shield Arc 70+	LNT Ni1	LNM Ni1	Outershield 81Ni1-H/HSR	Innershield NR208-H	LNS 163 with flux 960
3 Conarc 55CT	LNT 28	LNM 28	Outershield 500CT-H		LNS 164 with flux P240, 8500, 888
4 Conarc 60G	LNT Ni1	LNM Ni1, LNM 28	Outershield 81K2-H/HSR		
5 Conarc 70G	LNT Ni2.5	LNM Ni2.5	Outershield 91K2-HSR		
6 Conarc 74	LNT Ni1	LNM Ni1	Outershield 81Ni1-H/HSR		
7 Conarc 80	-	-	Outershield 690-H/HSR		LNS 166, LNS T690 with flux P230, P240, 8500, 888
8 Conarc 85	-	LNM MoNiVa			
9 Kryo 1				Innershield NR-203Ni1	
10 Kryo 1N	LNT Ni1	LNM Ni1	Outershield 81Ni1-H/HSR	Innershield NR-203Ni-C	LNS 160, LNS 165 with flux P230, P240, 8500, 888
11 Kryo 1P				Innershield NR-400	
12 Kryo 2	LNT Ni2.5	LNM Ni2.5	Outershield 81K2-H/HSR		LNS 162 with flux P230, P240, 8500, 888
13 Kryo 3	LNT Ni2.5	LNM Ni2.5	-		LNS 175 with flux P240, 8500, 888
14 Kryo 4					LNS 140A with flux 860, P230
15 SL 12G	LNT 12	LNM 12	Outershield 12-H		LNS 150 with flux P230, P240, 8500, 888
16 SL 19G	LNT 19	LNM 19	Outershield 19-H		LNS 151 with flux P230, P240, 8500, 888
17 SL 20G	LNT 20	LNM 20	Outershield 20-H		
18 SL 22G	-	-	-		
19 SL 502	LNT 502	-	-		LNS 502 with flux P230, P240, 8500
20 SL 9Cr(P91)	LNT 9Cr(P91)	-	-		

All information in this data sheet is accurate to the best of our knowledge at the time of printing. Please refer to www.lincolnelectric.eu for any updated information. Fumes: Safety Data Sheets (SDS) are available on our website.

Covered electrodes	TIG rods	MIG/MAG wires	Gas shielded flux-cored wires	Self shielded flux-cored wires	SAW wires / flux
1 Arosta 304L					
2 Limarosta 304L	LNT 304LSI	LNM 304LSI	Cor-A-Rosta [P]304L	-	1
3 Vertarosta 304L			Cor-A-Rosta 304L	-	2
4 Jungo 304L	LNT 304L	LNM 304L	Cor-A-Rosta P304L	-	3
5 Limarosta 304L-130	LNT 304LSI	LNM 304LSI	Cor-A-Rosta [P]304L	-	4
6 Arosta 347	LNT 347	LNM 347	Cor-A-Rosta 347	-	5
7 Jungo 347				-	6
8 Arosta 316L			Cor-A-Rosta [P]316L	-	7
9 Limarosta 316L	LNT 316LSI	LNM 316LSI	Cor-A-Rosta 316L	-	8
10 Vertarosta 316L			Cor-A-Rosta P316L	-	9
11 Jungo 316L	LNT 316L	LNM 316L	Cor-A-Rosta [P]316L	-	10
12 Limarosta 316L-130	LNT 316LSI	LNM 316LSI	Cor-A-Rosta 316L	-	11
13 Arosta 318	LNT 318SI	LNM 318SI		-	12
14 Jungo 318L				-	13
15 Jungo 4439		LNM 4439Mn		-	14
16 Jungo 4455		LNM 4455		-	15
17 Jungo 4465				-	16
18 Jungo 4500	LNT 4500	LNM 4500		-	17
19 Arosta 4462	LNT 4462	LNM 4462	Cor-A-Rosta [P]4462	-	18
20 Jungo 4462				-	19
21 Jungo 309L				-	20
22 Arosta 309S	LNT 309LSI	LNM 309LSI	Cor-A-Rosta [P]309L	-	21
23 Limarosta 309S			Cor-A-Rosta 309L	-	22
24 Arosta 309Mo				-	23
25 Nichroma	LNT 309LSI	LNM 309LSI	Cor-A-Rosta [P]309[Mo]L	-	24
26 Nichroma 160				-	25
27 Limarosta 312		LNM 12		-	26
28 Arosta 307		LNM 37		-	27
29 Arosta 307-160				-	28
30 Jungo 307				-	29
31 Arosta 304-H	LNT 304-H	LNM 304-H		-	30
32 Arosta 309-H		LNM 309-H		-	31
33 Intherma 310 / 310B	LNT 310	LNM 310		-	32
				-	33

Covered electrodes	TIG rods	MIG/MAG wires	Gas shielded flux-cored wires	Self shielded flux-cored wires	SAW wires / flux
Copper & Nickel base alloys					
1 Nicro 31/27	-	-	-	-	-
2 Nicro 60/20	LNT Nicro 60/20	LNM Nicro 60/20	-	-	LNS NiCro 60/20 with flux P2007
3 Nicro 70/15	-	-	-	-	-
4 Nicro 70/15Mn	LNT Nicro 70/19	LNM Nicro 70/19	-	-	-
5 Nicro 70/19	-	-	-	-	-
6 MicroMo 60/16	-	-	-	-	LNS NiCroMo 60/16 with flux P2007
7 -	LNT NiTi	LNM NiTi	-	-	-
8 Nicu 70/30	LNT NiCu70/30	-	-	-	-
9 Nyloid 2	LNT Nicro 60/20	LNM Nicro 60/20	-	-	LNS NiCro 60/20 with flux P2007
10 Nyloid 4	-	-	-	-	LNS NiCroMo 60/16 with flux P2007
11	LNT CuNi 30	LNM CuNi 30	-	-	-
12 -	-	LNM CuSn	-	-	-
13 -	LNT CuSn16	-	-	-	-
14 -	LNT Cu513	LNM Cu513	-	-	-
15 -	-	LNM CuA8	-	-	-
16 -	-	LNM CuA18Ni6	-	-	-
Aluminium alloys					
1 Al99.8	Superglaze TIG 1070	Superglaze MIG 1070	-	-	-
2 AlMn	-	-	-	-	-
3 -	Superglaze TIG 1070	Superglaze MIG 1070	-	-	-
4 -	Superglaze TIG 5754	Superglaze MIG 5754	-	-	-
5 -	Superglaze TIG 5356	Superglaze MIG 5356	-	-	-
6 -	Superglaze TIG 5183	Superglaze MIG 5183	-	-	-
7 -	Superglaze TIG 5087	Superglaze MIG 5087	-	-	-
8 -	Superglaze TIG 4043	Superglaze MIG 4043	-	-	-
9 -	Superglaze TIG 4047	Superglaze MIG 4047	-	-	-

Covered electrodes	TIG rods	MIG/MAG wires	Gas shielded flux-cored wires	Self shielded flux-cored wires	SAW wires / flux
Cast iron					
1 Reptec Cast 1	LNT NITi	LNM NITi	-	-	-
2 Reptec Cast 3	-	LNM NiFe	-	-	-
3 Reptec Cast 31	-	LNM NiFe	-	-	-
Hardfacing applications					
1 Wearshield BU 30	-	-	-	Lincore 33	Lincore 30-S with flux 801
2 Wearshield Mangjet (e)	-	-	-	-	-
3 Wearshield 15CrMn	-	-	-	Lincore 15CrMn	-
4 Wearshield MM40	-	LNM 4M	-	Lincore 40-0	-
5 Wearshield MM	-	-	-	Lincore 55	-
6 Wearshield T&D	-	-	-	Lincore T&D	-
7 Wearshield MI(e)	-	-	-	Lincore 50, Lincore 55	Lincore 50 with flux 801
8 Wearshield ABR	-	-	-	-	-
9 Wearshield 44	-	-	-	-	-
10 Wearshield ME(e)	-	-	-	Lincore 60-0	L-60 with flux HS60
11 Wearshield 60 (e)	-	-	-	-	-
12 Wearshield 50M	-	-	-	-	-
13 Wearshield 70	-	-	-	Lincore 65-0	-
14 Wearshield 420	-	LNM 420FM	-	Lincore 420	L-60 with flux 802

ISO 3580-A

Classification of covered electrodes for Manual Metal Arc Welding of creep resistant steels

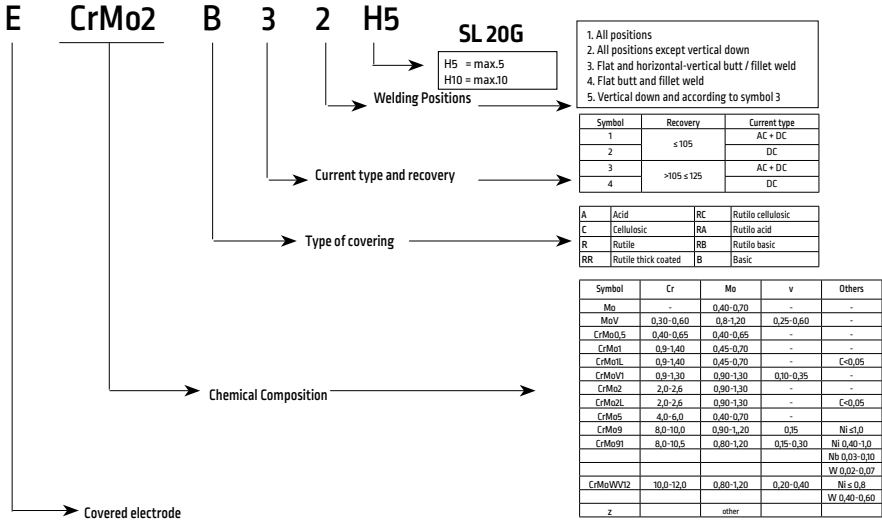

ISO 3581-A

Classification of covered electrodes for Manual Metal Arc Welding of stainless and heat-resisting steels

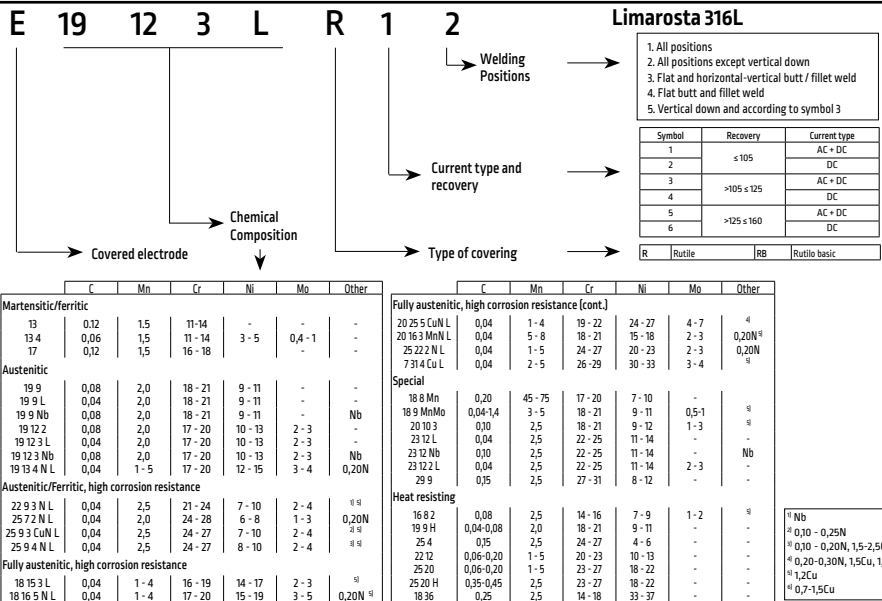

ISO 2560-A

Classification of covered electrodes for Manual Metal Arc Welding of non alloyed and fine grain steels

E 50 6 MnNi B 3 2 H5 H_{DM} (ml/100g) **Kryo 1**

no requirem.
A = +20°C
0 = 0°C
2 = -20°C
3 = -30°C
4 = -40°C
5 = -50°C
6 = -60°C

Welding Positions
Current type and recovery
Type of covering
Chemical Composition
Minimum impact of avg. 47 Joule at
Min. yield strength (N/mm²)
Covered electrode

H5 = max.5
H10 = max.10
H15 = max.15

1. All positions
2. All positions except vertical down
3. Flat and horizontal-vertical butt / fillet weld
4. Flat butt and fillet weld
5. Vertical down and according to symbol 3

Symbol	Recovery	Current type
1	≤105	AC + DC
2		DC
3	>105 ≤ 125	AC + DC
4		DC
5	> 160	AC + DC
6		DC

A	RC	Rutile cellulosic
C	RA	Rutile acid
R	RB	Rutile basic
RR	B	Basic

Symbol	Mn	Ni	Mo
Mo	1,4	-	0,3-0,6
MnMo	>1,4-2,0	-	0,3-0,6
1Ni	1,4	0,6-0,12	-
2Ni	1,4	1,8-2,6	-
3Ni	1,4	>2,6-3,8	-
MnNi	>1,4-2,0	0,6-0,12-	-
1NiMo	1,4	0,6-0,12	0,3-0,6
Z		other	

Symbol	Yield	Tensile	A ₅
35	≥ 355	440-570	≥ 22%
38	≥ 380	470-600	≥ 20%
42	≥ 420	500-640	≥ 20%
46	≥ 460	530-680	≥ 20%
50	≥ 500	560-720	≥ 18%

EN-ISO 18275-A

Classification of covered electrodes for Manual Metal Arc Welding of high strength steels

Conarc 70G

E 55 4 1NiMo B 3 2 H5 T H_{DM} (ml/100g) **Stress relieved 1h/560-600°C**

no requirem.
A = +20°C
0 = 0°C
2 = -20°C
3 = -30°C
4 = -40°C
5 = -50°C
6 = -60°C
7 = -70°C
8 = -80°C

Welding Positions
Current type and recovery
Type of covering
Chemical Composition
Minimum impact of avg. 47 Joule at
Min. yield strength (N/mm²)
Covered electrode

H5 = max.5
H10 = max.10

1. All positions
2. All positions except vertical down
3. Flat and horizontal-vertical butt / fillet weld
4. Flat butt and fillet weld
5. Vertical down and according to symbol 3

Symbol	Recovery	Current type
1	≤ 105	AC + DC
2		DC
3	>105 ≤ 125	AC + DC
4		DC
5	> 160	AC + DC
6		DC

A	RC	Rutile cellulosic
C	RA	Rutile acid
R	RB	Rutile basic
RR	B	Basic

Symbol	Mn	Ni	Cr	Mo
MnMo	1,4-2,0	-	-	0,3-0,6
MnNi	1,4-2,0	0,6-1,2	-	-
1NiMo	<1,4	0,6-1,2	-	0,3-0,6
1.5NiMo	<1,4	1,2-1,8	-	0,3-0,6
2NiMo	<1,4	1,8-2,6	-	0,3-0,6
MnNiMo	1,4-2,0	0,6-1,2	-	0,3-0,6
Mn2NiMo	1,4-2,0	1,8-2,6	-	0,3-0,6
Mn2NiCrMo	1,4-2,0	1,8-2,6	0,3-0,6	0,3-0,6
Mn2NiCrMo	1,4-2,0	1,8-2,6	0,6-1,0	0,3-0,6
Z		other		

Symbol	Yield	Tensile	A ₅
55	≥ 550	610-780	≥ 18%
62	≥ 620	690-890	≥ 18%
69	≥ 690	760-960	≥ 17%
79	≥ 790	880-1080	≥ 16%
89	≥ 890	980-1180	≥ 15%

ISO 14341-A

Classification of solid wires and deposits for MIG/MAG Welding
of non alloy and fine grain steels

G 46 3 M G3Si1 LNM 26

Z = no requirement.
A = +20°C
O = 0°C
2 = -20°C
3 = -30°C
4 = -40°C
5 = -50°C
6 = -60°C

Chemical composition

Symbol	Si	Mn	Ni	Mo
G0				
G2Si	0,50-0,80	0,90-1,30	0,15	0,15
G3Si1	0,70-1,00	1,30-1,60	0,15	0,15
G4Si1	0,80-1,20	1,60-1,90	0,15	0,15
G3Si2	1,00-1,30	1,30-1,60	0,15	0,15
			Al	Ti + Zr
G2Ti	0,40-0,80	0,90-1,40	0,05-0,20	0,05-0,25
G3Ni1	0,50-0,90	1,00-1,60	0,80-1,50	0,15
G2Ni2	0,40-0,80	0,80-1,40	2,10-2,70	0,15
G2Mo	0,30-0,70	0,90-1,30	0,15	0,40-0,60
G4Mo	0,50-0,80	1,70-2,10	0,15	0,40-0,60
G2Al	0,30-0,50	0,90-1,30	0,15	0,35-0,75

Type of shielding gas

M = M2 mixed shielding gas (without helium)
C = 100 CO₂

Minimum impact of avg. 47 Joule at

Symbol	Yield	Tensile	A ₅
35	≥ 355	440-570	≥ 22%
38	≥ 380	470-600	≥ 20%
42	≥ 420	500-640	≥ 20%
46	≥ 460	530-680	≥ 20%
50	≥ 500	560-720	≥ 18%

Min. yield strength (N/mm²)

Solid wire for GMAW-process

EN/ISO 636-A

Classification of rods, wires and deposits for Tungsten Inert Gas Welding
of non alloy and fine grain steels

W 46 3 W3Si1 LNT 25

Chemical composition

Symbol	Si	Mn	Ni	Mo
W0				
W2Si	0,50-0,80	0,90-1,3		
W3Si1	0,70-1,00	1,30-1,60		
W4Si1	0,80-1,20	1,60-1,90		
			Al	Ti + Zr
W2Ti	0,40-0,80	0,90-1,40	0,05-0,20	0,05-0,25
W3Ni1	0,50-0,90	1,00-1,60	0,80-1,50	
W2Ni2	0,40-0,80	0,80-1,40	2,10-2,70	
W2Mo	0,30-0,70	0,90-1,30		0,40-0,60

Minimum impact of avg. 47 Joule at

Z = no requirement.
A = +20°C
O = 0°C
2 = -20°C
3 = -30°C
4 = -40°C
5 = -50°C
6 = -60°C

Min. yield strength (N/mm²)

Symbol	Yield	Tensile	A ₅
35	≥ 355	440-570	≥ 22%
38	≥ 380	470-600	≥ 20%
42	≥ 420	500-640	≥ 20%
46	≥ 460	530-680	≥ 20%
50	≥ 500	560-720	≥ 18%

GTAW-process, wire and weld metal

ISO 14343-A

Classification of wire electrodes, wires and rods for arc welding stainless and heat-resisting steels

G 19 12 3 L Si **LNM 316 LSi**

G = GMAW
W = GTAW
P = PAW
S = SAW

Chemical composition → Classification
Si = 0,65 - 1,2%

	C	Mn	Cr	Ni	Mo	Other
Martensitic/ferritic						
13	0,12	1,5	11-14	-	-	-
13.4	0,06	1,5	11-14	3-5	0,4-1	-
17	0,12	1,5	16-18	-	-	-
Austenitic						
19 9	0,08	2,0	18-21	9-11	-	-
19 9 L	0,04	2,0	18-21	9-11	-	-
19 9 Nb	0,08	2,0	18-21	9-11	-	Nb
19 12 2	0,08	2,0	17-20	10-13	2-3	-
19 12 3 L	0,04	2,0	17-20	10-13	2-3	-
19 12 3 Nb	0,08	2,0	17-20	10-13	2-3	Nb
19 13 4 N L	0,04	1-5	17-20	12-15	3-4	0,20N
Austenitic/Ferritic, high corrosion resistance						
22 9 3 N L	0,04	2,5	21-24	7-10	2-4	Si
25 7 2 N L	0,04	2,0	24-28	6-8	1-3	0,20N
25 9 3 Cu N L	0,04	2,5	24-27	7-10	2-4	Si
25 9 4 N L	0,04	2,5	24-27	8-10	2-4	Si
Fully austenitic, high corrosion resistance						
18 15 3 L	0,04	1-4	16-19	14-17	2-3	Si
18 16 5 N L	0,04	1-4	17-20	15-19	3-5	0,20N

	C	Mn	Cr	Ni	Mo	Other
Fully austenitic, high corrosion resistance (cont.)						
20 25 5 Cu N L	0,04	1-4	19-22	24-27	4-7	Si
20 16 3 Mn N L	0,04	5-8	18-21	15-18	2-3	0,20N
25 22 2 N L	0,04	1-5	24-27	20-23	2-3	Si
7 31 4 Cu L	0,04	2-5	26-29	30-33	3-4	Si
Special						
18 8 Mn	0,20	45-75	17-20	7-10	-	-
18 9 MnMo	0,04-1,4	3-5	18-21	9-11	0,5-1	Si
20 10 3	0,10	2,5	18-21	9-12	1-3	Si
23 12 L	0,04	2,5	22-25	11-14	-	-
23 12 Nb	0,10	2,5	22-25	11-14	-	Nb
23 12 2 L	0,04	2,5	22-25	11-14	2-3	-
29 9	0,15	2,5	27-31	8-12	-	-
Heat resisting						
16 8 2	0,08	2,5	14-16	7-9	1-2	Si
19 9 H	0,04-0,08	2,0	18-21	9-11	-	-
25 4	0,15	2,5	24-27	4-6	-	-
22 12	0,06-0,20	1-5	20-23	10-13	-	-
25 20	0,06-0,20	1-5	23-27	18-22	-	-
25 20 H	0,35-0,45	2,5	23-27	18-22	-	-
18 36	0,25	2,5	14-18	33-37	-	-

1 Nb
2 0,10 - 0,25N
3 0,10 - 0,20N, 1,5-2,5Cu
4 0,20-0,30N, 1,5Cu, 1,0W
5 1,2Cu
6 0,7-1,5Cu

Solid wire for:

EN/ISO 17632-A

Classification of tubular electrodes for metal arc welding with or without a gas shield of non alloy and fine grain steels

T 50 5 1Ni P M 2 H5 **Outershield 81Ni-H**

T = no requirement.
A = +20°C
0 = 0°C
2 = -20°C
3 = -30°C
4 = -40°C
5 = -50°C
6 = -60°C

H_{DM} (ml/100g)
H5 = max.5
H10 = max.10
H15 = max.15

Welding positions

Type of shielding gas

Type of electrode core

Chemical composition

Minimum impact of avg. 47 Joule at

Min. yield strength (N/mm²)

Flux-cored wire

1. All positions
2. All positions except vertical down
3. Flat and horizontal-vertical butt / fillet weld
4. Flat butt and fillet weld
5. Vertical down and according to symbol 3

M = M2 mixed shielding gas (without helium)
C = 100 CO₂

Symbol Characteristics

With shielding gas (C en M2)
R Rutile, slow freezing slag
P Rutile, fast freezing slag
B Basic
M Metal powder

Without shielding gas
V Rutile or basic / fluoride
W Basic/fluoride, slow freezing slag
Y Basic/fluoride, fast freezing slag
S Other types

Symbol	Mn	Ni	Mo
-	2,0	-	-
Mo	1,4	-	0,3-0,6
MnMo	>1,4-2,0	-	0,3-0,6
1Ni	1,4	0,6-0,12	-
2Ni	1,4	1,8-2,6	-
3Ni	1,4	>2,6-3,8	-
MmNi	>1,4-2,0	0,6-0,12	-
1NiMo	1,4	0,6-0,12	0,3-0,6
Z	-	other	-

Symbol	Yield	Tensile	A ₅
35	≥ 355	440-570	≥ 22%
38	≥ 380	470-600	≥ 20%
42	≥ 420	500-640	≥ 20%
46	≥ 460	530-680	≥ 20%
50	≥ 500	560-720	≥ 18%

ISO 14174

Classification of flux for submerged arc welding

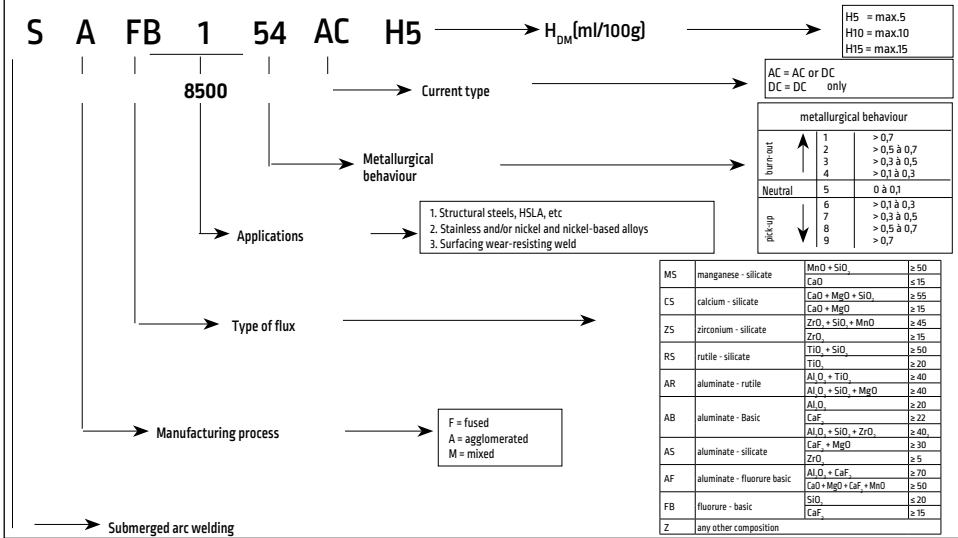

ISO 14171-A

Classification of wire and wire/flux combinations for submerged arc welding of non alloy and fine grain steels

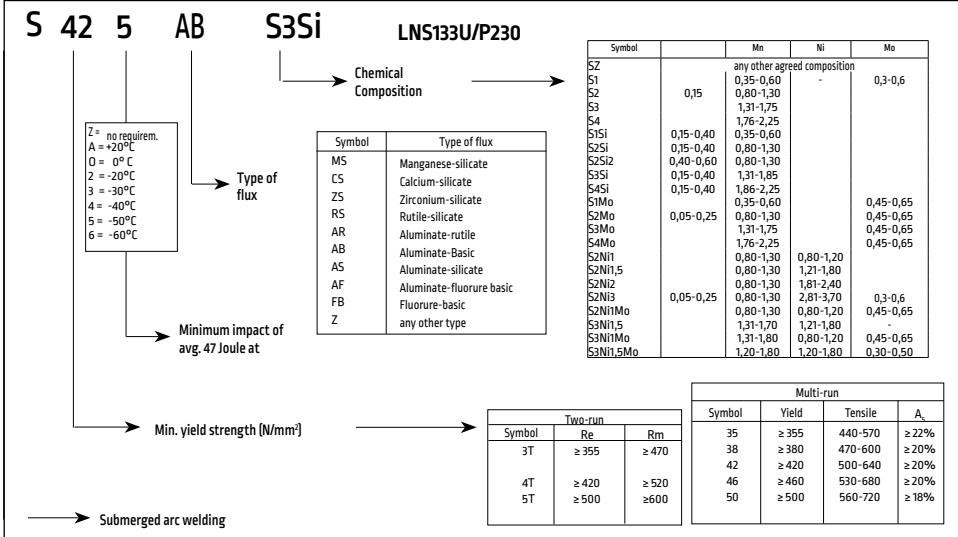

A-Number according ASME Section IX, QW-442

- Applicable only to ferrous metals
- Identification of weld metal chemical composition designated on PQR and WPS

F-Number according ASME Section IX, QW-432

The F-Number grouping of electrodes and welding rods is based on their usability characteristics, which fundamentally determines the ability of welders to make satisfactory welds with a given filler metal. This grouping is made to reduce the number of welding procedure and performance qualifications, where this can logically be done. The grouping does not imply that base metals or filler metals within a group may be indiscriminately substituted for a metal that was used in the qualification test without consideration of the compatibility of the base and filler metals from the standpoint of metallurgical properties, post weld heat treatment design and service requirements, and mechanical properties.

FM-Filler material groups according EN 9606-1 [previously EN 287-1]

Group Welding consumable for welding of :

- FM1 Non-alloy and fine grain steels
- FM2 High strength steels
- FM3 Creep-resisting steels $Cr < 3.75$
- FM4 Creep-resisting steels $3.75 \leq Cr \leq 12\%$
- FM5 Stainless and heat-resisting
- FM6 Nickel and nickel alloys

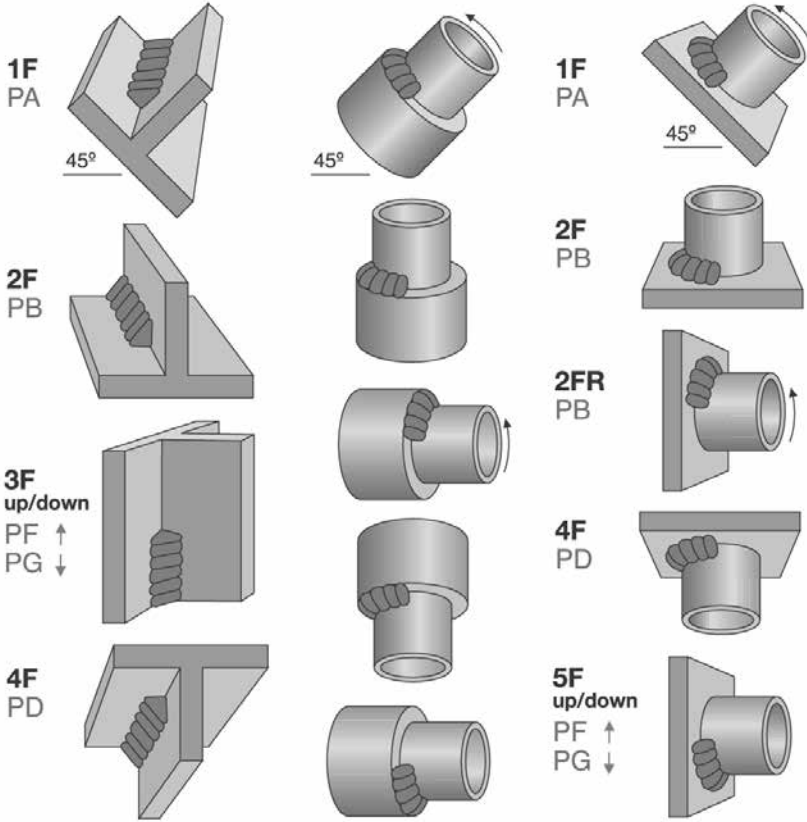

Qualification test

Qualified for fillet welds

	Position	Plate	Pipe
Plate-fillet	1F	1F	1F
	2F	1F, 2F	1F, 2F, 2FR
	3F	1F, 2F, 3F	1F, 2F, 2FR
	4F	1F, 2F, 4F	1F, 2F, 2FR, 4F
	3F + 4F	All qualifications	All qualifications
Pipe-fillet	1F	1F	1F
	2F	1F, 2F	1F, 2F, 2FR
	2FR		1F, 2FR
	4F	1F, 2F, 4F	1F, 2F, 2FR, 4F
	5F	All qualifications	All qualifications

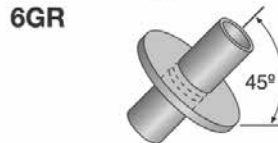
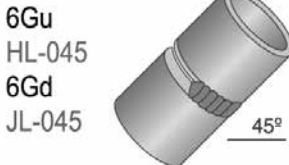
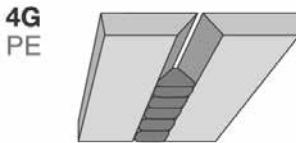
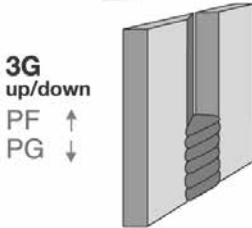
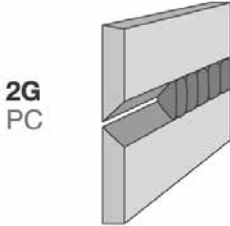
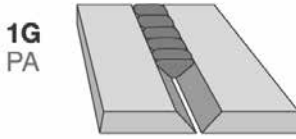

Qualification test	Qualified for groove welds		Qualified for fillet welds	
Position	Plate	Pipe	Plate	Pipe

Plate-groove	1G	1G	1G	1F	1F
	2G	1G, 2G	1G, 2G	1F, 2F	1F, 2F, 2FR
	3G	1G, 3G		1F, 2F, 3F	1F, 2F, 2FR
	4G	1G, 4G		1F, 2F, 4F	1F, 2F, 2FR, 4F
Pipe-groove	1G	1G	1G	1F	1F
	2G	1G, 2G	1G, 2G	1F, 2F	1F, 2F, 2FR
	5G	1G, 2G, 4G	1G, 2G	1F, 2F, 4F	All qualifications
	6G + 6GR	All qualifications	All qualifications	All qualifications	All qualifications
	2G + 5G	All qualifications	All qualifications	All qualifications	All qualifications

SELECTION TABLE (Applications in low temperature steel)

WELDING CONSUMABLES FOR LOW TEMPERATURE SERVICE

Application	Type of gas	Boiling Point		Applicable down to		Consumables					
		°C	K	°C	K	SMAW	MIG/MAG	TIG	FCW	SAW	
Fine grained steel with increasing strength	CO ₂ (to 1.5 at%)	-28	245	-40	233	Baseo G Conarc 49C/57/V180	LNM 26 Supra MIG	LNT 25 LNT 26	OS MC700 (-20°) OS MC710-H OS MC715-H OS T15-H OS 81W11-H /HSR	L61(LNS 129/860 (-20°C) LNS 139/860 (-20°C) L50M/LNS 133UP230	
		-42	231	-51	222	Conarc 60C70G/80/85			OS 81K2-H /HSR OS 91K2-HSR OS 91W11-HSR	LNS 160 / P230/P240/888/8500	
		-78	195	-60	213	Kryo1 Kryo2	LNM Ni1	LNT Ni1		LNS 162 / P230/P240/888/8500	
12 Ni 14	CO ₂ (solid) Acetylene Ethane Ethylene	-84	189	-80	193	Kryo3	LNM Ni2.5	LNT Ni2.5			
		-88	185			Nyloid 2	LNM NiCro 70/19	LNT NiCro 70/19		LNS 4455 / P 2007	
		-104	169	-105	168						
X12 Ni 5	Krypton Methane	-153	120	-165	108	Nyloid 2	LNM NiCro 70/19 LNM 4455	LNT NiCro 70/19 LNT 4455		LNS NiCro60/20 / P2007 LNS 4455 / P2007	
		-161	112								
X8 Ni 9 Austenitic CrNi steel	Oxygen Argon Nitrogen	-183	90	-196	77	Nyloid 2	LNM NiCro 70/19	LNT NiCro 70/19		LNS NiCro 60/20 / P2007	
		-186	87			Jungo 304L NiCro 70/15 NiCro 70/19	LNM 4455 LNM 304LSi LNM NiCro 70/19	LNT 4455 LNT 304L LNT NiCro 70/19	Cor-A-Rosta P304L	LNS 4455 / P2007 LNS 304L / P2007	
		-196	77			NiCro 60/20 Arosta 4439	LNM NiCro 60/20 LNM 4439Mn	LNT NiCro 60/20 LNT 4439Mn		LNS NiCro 60/20 / P2007 LNM 4439Mn / P2007	
X2 CrNi19-11 X2 CrNiMo17-12-2	Hydrogen Helium	-253	-20	-196	77		LNM 4455	LNT 4455		LNS 4455 / P2007	
		-269	4			Jungo 4455	LNM 4455	LNT 4455			

		Max. service temp.weld metal [°C]									
		500	550	600	600	600	600	700	700	750	900
EN	EN/DIN	DIN	DIN	EN/DIN	DIN	EN/DIN	DIN	EN/DIN	DIN	DIN	
		EN/DIN	EN/DIN	EN/DIN	EN/DIN	EN/DIN	EN/DIN	EN/DIN	EN/DIN	EN/DIN	EN/DIN
P395 GH 1.0481	16CrMo4-5 1.7335	14MoV6-3 1.7715	10CrMo9-10 1.7380	12CrMo19-5 1.7362	X12CrMo9-1 1.7386	X20CrMoV12-1 1.4922	X6CrNi18-11 1.4948	X6CrNiMo17-13 1.4919	X3CrNi18-11 1.4949	X10NiCrAlTi3220 1.4976	
P395 GH 1.0473	16CrMo4-4 1.7337	17MnMoV6-4 1.5403	12CrMo9-10 1.7375	12CrMo9-10 1.7375	X4CrNi18-10 1.4301	X20CrMoV12-1 1.4935	X4CrNi18-10 1.4301	X3CrNiMo17-13 1.4910	(Alloy 800H) NiCr-15Fe 2.4916	(Alloy 600) NiCr-23Fe 2.4951	
16M03 1.5415	22CrMo4-4 1.7350	10CrSiMoV7 1.8075	10CrSiMoV7 1.8075	10CrSiMoV7 1.8075	X4CrNiMo17-12-2 1.4401	GX5CrNi19-10 1.4308	X4CrNi19-10 1.4308	X4CrNiMo17-12-2 1.4401	(Alloy 601H)		
17M03 [1.5415]	G5-22CrMo54 1.7354		17CrMoV10 1.7766		X3CrNi18-11 1.4949						
14M06 1.5423	25CrMo4 1.7218										
P265 GH 1.0425											
	ASTM	ASTM	ASTM	ASTM	ASTM	ASTM	ASTM	ASTM	ASTM	ASTM	
A285G/A/B/C A299 A414gr.B-F A515 A516 gr. 70 A662 gr. B A 537 gr.1 A161 gr. T1 AR2 gr. F1 A204 gr. A-C A369 gr. FP1	A387G-T1/2 A213G-T1/2/3 A335G-P2/1 A336G-F1/2/1 A515 A182G-F1/2/1/2 A199G-T2 A200G-T2 A336G-F2 A356G-F6 A519G-G130	A405Gr P24 A199G-T91 A200GrT91 A213GrT91 A335G-F91 A336G-F91 A387G-F2 A395G-F5 SA423T91 A357 A369GrFP91 A473TP501 A473TP502 AISI TP901 AISI TP502 SAE51501 SAE51502	A182G-F5 A199G-T91 A200GrT91 A213GrT91 A335G-F91 A336G-F91 A387G-F2 A395G-F5 SA423T91 A357 A369GrFP91 A473TP501 A473TP502 AISI TP901 AISI TP502 SAE51501 SAE51502	A182G-F5 A199G-T91 A200GrT91 A213GrT91 A335G-F91 A336G-F91 A387G-F2 A395G-F5 SA423T91 A357 A369GrFP91 A473TP501 A473TP502 AISI TP901 AISI TP502 SAE51501 SAE51502	A182G-F5 A199G-T91 A200GrT91 A213GrT91 A335G-F91 A336G-F91 A387G-F2 A395G-F5 SA423T91 A357 A369GrFP91 A473TP501 A473TP502 AISI TP901 AISI TP502 SAE51501 SAE51502	A182G-F5 A199G-T91 A200GrT91 A213GrT91 A335G-F91 A336G-F91 A387G-F2 A395G-F5 SA423T91 A357 A369GrFP91 A473TP501 A473TP502 AISI TP901 AISI TP502 SAE51501 SAE51502	A182G-F5 A199G-T91 A200GrT91 A213GrT91 A335G-F91 A336G-F91 A387G-F2 A395G-F5 SA423T91 A357 A369GrFP91 A473TP501 A473TP502 AISI TP901 AISI TP502 SAE51501 SAE51502	A182G-F5 A199G-T91 A200GrT91 A213GrT91 A335G-F91 A336G-F91 A387G-F2 A395G-F5 SA423T91 A357 A369GrFP91 A473TP501 A473TP502 AISI TP901 AISI TP502 SAE51501 SAE51502	A182G-F5 A199G-T91 A200GrT91 A213GrT91 A335G-F91 A336G-F91 A387G-F2 A395G-F5 SA423T91 A357 A369GrFP91 A473TP501 A473TP502 AISI TP901 AISI TP502 SAE51501 SAE51502	A182G-F5 A199G-T91 A200GrT91 A213GrT91 A335G-F91 A336G-F91 A387G-F2 A395G-F5 SA423T91 A357 A369GrFP91 A473TP501 A473TP502 AISI TP901 AISI TP502 SAE51501 SAE51502	
SMAW	SL19G SL19G(STC)	SL22G	SL20G SL20G(STC)	SL502	SL9Cr(P91)	SL4935	Arosta304H	Arosta304H	Arosta304H	NiCro 70/15Mn NiCro 70/19 NiCro 60/20	
TIG	LNT12 LNT19	LNT19	LNT20	LNT20	LNT9Cr(P91)	LNT502	LNT304H	LNT304H	LNT304H	LNT NiCro 70/19 LNT NiCro 60/20	
MIG/MAG	LNM12 LNM19	LNM19	LNM20	LNM20	LNM20	LNM20	LNM304H	LNM304H	LNM304H	LNM NiCro 70/19 LNM NiCro 60/20	
FCW	OS12-H OS19-H	OS19-H	OS20-H	OS20-H	OS20-H	OS20-H	LNS304-H	LNS304-H	LNS304-H	LNS NiCro 60/20 P2007	
SAW	LNS140A P230	LNS150 P240/888	LNS151 P240/888	LNS151 P240/888	LNS304-H P2007/P2000	LNS304-H P2007/P2000	LNS304-H P2007/P2000	LNS304-H P2007/P2000	LNS304-H P2007/P2000	LNS NiCro 60/20 P2007	

Base materials

Products

1),2),3) corresponding base and welding materials

a) solution annealed, tempered at max. 600°C

b) pressure vessels max. 450°C

		Max. service temp/weld metal [°C]							
		1000	1050	1100	1100	1100	1100	1200	
		steel with approximately							
		22%Cr, 12%Ni	25%Cr, 4%Ni, 0.4%C	25%Cr, 20%Ni	36%Ni, 18%Cr	36%Ni, 25%Cr	25%Cr, 20%Ni		
EN	EN/DIN	EN/DIN	EN/DIN	DIN	DIN	DIN	DIN	EN/DIN	EN/DIN
NiCr22Mo9Nb 2.4566 ¹ (Alloy 625)	X15 CrNiSi20-12 1.4828 ¹	X20 CrNiSi25-4 1.4821	GX40 CrNiSi25-20 1.4848	X17 NiCrSi36-16 1.4864	GX40 NiCrSiB35-25 1.4857	X12 CrNi26-21 1.4845	X16 CrNiSi25-20 1.4841		
X2 NiCrAlTi32.20 1.4568 ³ (Alloy 800L)	X12 CrNiTi18-9 1.4878 ¹	GX40 CrNi24-5 1.4822	GX40 NiCrSi25-12 1.4837	GX40 NiCrSi36-18 1.4865	GX40 NiCrSiNb38-25 1.4852	X12 CrNi26-21 1.4845	X16 CrNiSi25-20 1.4841		
X10 NiCrAlTi32.20 1.4876 ³ (Alloy 800H)	GX40 CrNiSi22-9 1.4826 ¹ GX25 CrNiSi20-14 1.4832 ¹ GX25 CrNiSi18-9 1.4825 ¹ GX30 CrSi13 1.4710 ² GX40 CrSiTB 1.4729 ³ GX40 CrSiT7 1.4740 ¹	GX40 CrNiSi27-4 1.4823 X10 CrAl7 1.4773 X10 CrAlTB 1.4724 X10 CrAl18 1.4742 X10 CrAl24 1.4762	GX40 NiCrSi25-20 1.4848	GX40 NiCrSi36-18 1.4865	GX40 NiCrSiNb38-25 1.4852	X12 CrNi26-21 1.4845	X16 CrNiSi25-20 1.4841		
Base materials									
	ASTM	AISI	AISI	AISI	AISI	AISI	AISI	AISI	
		309 G ¹ TP302 B ¹ TP321 ¹	TP 327	314	TP 330	310	TP310 TP314		
			ASTM	ASTM	ASTM	ASTM	ASTM		
	B163GrN08 ² BA07Gr10 ²	A297GrHC A297GrHC	A297GrHK A297GrHH	A297GrHU A351GrHT30	A351GrC20				
SMAW NiCr 6020 ¹	Amsta 309H ^{1,2} Amsta 329 ³	Amsta 329	NiCr 70/19* NiCr 70/15* NiCr 70/15Min*	NiCr 70/19* NiCr 70/15* NiCr 70/15Min*	NiCr 70/19* NiCr 70/15* NiCr 70/15Min*		Intherma 310		
TIG LNT NiCr 60/20	LNT NiCr 60/20	LNT NiCr 60/20					LNT310		
MIG/ MAG LNM NiCr 60/20	LNM NiCr 60/20	LNM NiCr 60/20					LNM 310		
SAW LNS NiCr 60/20 P2007	LNS NiCr 60/20 P2007	LNS NiCr 60/20 P2007					LNS NiCr 60/20 P2007		
Products									

1), 2) corresponding base- and weld materials
* only for repair welding

COVERED ELECTRODE SELECTION TABLE FOR STAINLESS STEEL

Material number	EN Code	Electrode type		Remarks
		First choice	Second choice	
Ferritic chromium steel				
1.4000	X6Cr13	Arosta 309S Limarosta 309S	Arosta 329 Nichroma Arosta 309Mo	Arosta 329, when low Ni-content is required, for heavy material possibly only the capping layer
1.4001	*X7Cr14			
1.4002	X6CrAl13			
1.4006	X12Cr13			
1.4008	*GX8CrNi13			
1.4016	*X6Cr17			
1.4021	X20Cr13			
1.4024	*X15Cr13			
1.4027	*GX20Cr14			
Martensitic chromium steel				
1.4113	X6CrMo17.1	Nichroma Arosta 309Mo	Arosta 329 Arosta 309S Limarosta 309S	Arosta 329, when low Ni-content is required, for heavy material possibly only the capping layer
1.4120	*X20CrMo13			
Austenitic chromium-nickel steel				
1.4301	X4CrNi18-10	Arosta 304L Vertarosta 304L	Arosta 347	
1.4303	X4CrNi18-12			
1.4306	X2CrNi19-11			
1.4308	GX5CrNi18-10			
1.4310	X10CrNi18-8			
1.4311	X2CrNiN18-10			
1.4312	*GX10CrNi18-8			
1.4318	X2CrNiN18-7			
1.4335	X1CrNi25-21	Jungo 4465		
1.4347	*GX8CrNi26-7	See Metrode range	Jungo 4462	
1.4362	X2CrNiN23-4	Arosta 4462	Jungo 4462	

* DIN/SEW

COVERED ELECTRODE SELECTION TABLE FOR STAINLESS STEEL

Material number	EN Code	Electrode type		Remarks
		First choice	Second choice	
Austenitic chromium-nickel steel				
1.4401	X4CrNiMo 17-12-2	Arosta 316L Limarosta 316L-130 Limarosta 316L Vertarosta 316L		
1.4404	X2CrNiMo 17-12-2			
1.4406	X2CrNiMoN 17-11-2			
1.4408	GX5CrNiMo 19-11			
1.4428	X2CrNiMo 18-12-3			
1.4429	X2CrNiMoN 17-13-3			
1.4432	X2CrNiMo 17-12-3			
1.4435	X2CrNiMo 18-14-3			
1.4436	X4CrNiMo 17-13-3			
1.4438	X2CrNiMo 18-15-4			
1.4439	X2CrNiMoN 17-13-5			
1.4446	GX2CrNiMoN 17-13-4			
1.4448	GX6CrNiMo 17-13			
1.4462	X2CrNiMoN 22-5-3	Arosta 4462/ Jungo 4462		
1.4465	X1CrNiMoN 25-25-2	Jungo 4465		
1.4466	X1CrNiMoN 25-22-2			
1.4468	*GX3CrNiMoN26-6-3	See Metrode range		
1.4469	*GX2CrNiMoN26-7-4			

All information in this data sheet is accurate to the best of our knowledge at the time of printing. Please refer to www.lincolnelectric.eu for any updated information. Fumes: Safety Data Sheets (SDS) are available on our website.

COVERED ELECTRODE SELECTION TABLE FOR STAINLESS STEEL AND NICKEL BASE ALLOYS

Material number	EN Code	Electrode type		Remarks
		First choice	Second choice	
Austenitic chromium-nickel steel				
1.4500	GX7NiCrMoCuNb 25-20	Jungo 4500	NiCro 31/27	
1.4503	X3NiCrMoTi 27-23	NiCro 31/27	NiCro 60/20	
1.4505	X4NiCrMoCuNb 20-18-2	Jungo 4500	NiCro 31/27	
1.4506	X5NiCrMoCuTi 20-18			
1.4510	X3CrTi17	Jungo 309L Arosta 309S Limarosta 309S	Arosta 329 Nichroma Arosta 309Mo	Arosta 329, when low Ni-content is required, for heavy material only the capping layer
1.4511	X3CrNb17			
1.4512	X6CrTi12			
1.4513	X6CrMo 17-1			
1.4515	*GX3CrNiMoCuN 26-6-3			
1.4517	*GX3CrNiMoCuN 26-6-3-3			
1.4529	X1NiCrMoCuN 25-20-7	NiCro 60/20 Jungo 4500	NiCroMo 59/23 NiCro 31/27 NiCro 60/20	
1.4531	GX2NiCrMoCuN 20-18			
1.4536	GX2NiCrMoCuN 25-20			
1.4539	X1NiCrMoCu 25-20-5			
1.4541	X6CrNiTi 18-10	Arosta 347	Arosta 304L Limarosta 304L	Type 304L, TÜV approval for service temperatures up to 350°C (intergranular corrosion)
1.4550	X6CrNiNb 18-10			
1.4552	GX5CrNiNb 18-9		Vertarosta 304L	
1.4558	*X2NiCrAlTi 32-20	NiCro 60/20	repair welding NiCro 70/19	
1.4559	*GX7NiCrMoCuNb 42-2			
1.4563	X1NiCrMoCu 31-27-4	NiCro 31/27	NiCro 60/20 Arosta 316L Limarosta 316L130	
1.4571	X6CrNiMoTi 17-12-2	Arosta 318	Limarosta 316L	Type 316L, TÜV approval for services temperatures up to 400°C (intergranular corrosion)
1.4573	*X10CrNiMoTi 18-12		Vertarosta 316L	
1.4577	X3CrNiMoTi 25-25	Jungo 4465		
1.4580	X6CrNiMoNb 17-12-2			
1.4581	*GX5CrNiMoNb 18-10	Arosta 318	Arosta 316L Limarosta 316L Vertarosta 316L	Arosta 4439, when weld metal ferrite should not exceed <0,5%
1.4583	*X10CrNiMoNb 18-12	Vertarosta 316L		
1.4585	GX7CrNiMoCuNb18-18	Jungo 4500	NiCro 31/27	
1.4586	X5NiCrMoCuNb22-18			

COVERED ELECTRODE SELECTION TABLE FOR STAINLESS STEEL AND NICKEL BASE ALLOYS

Material number	EN Code	Electrode type		Remarks
		First choice	Second choice	
Heat resistant steels				
1.4712 1.4713 1.4724 1.4742 1.4746 1.4762	X10CrSi 6 X10CrAl 7 X10CrAl 13 X10CrAl 18 X8CrTi 25 X10CrAl 24	Jungo 309L Arosta 309S Limarosta 309S	Arosta 329	Arosta 329, when low Ni-content is required, for heavy material only the capping layer
1.4821 1.4822 1.4823	X20CrNiSi 25-4 GX40CrNi 24-5 GX40CrNiSi 27-4	Arosta 329	Arosta 309S Limarosta 309S	
1.4825 1.4826 1.4828 1.4832 1.4833	GX25CrNiSi 18-9 GX40CrNiSi 22-9 X15CrNiSi 20-12 GX25CrNiSi 20-14 X7CrNi 23-14	Arosta 309H	NiCro 70/15Mn NiCro 70/15 NiCro 70/19	NiCro depends on service temperature
1.4837	GX40CrNiSi 25-12	NiCro 70/15/ NiCro 70/19	Arosta 309H	Arosta 309H depends on service temperature
1.4840 1.4841 1.4845 1.4847	GX15CrNi 25-20 X15CrNiSi 25-20 X12CrNi 25-21 X8CrNiAlTi 20-20	Intherma 310		
1.4846 1.4848 1.4849	X40CrNi 25-21 GX40CrNiSi 25-20 GX40NiCrSiNb 38-18	NiCro 70/15*	NiCro 70/15Mn*	
1.4850	X15NiCrNb 32-21		NiCro 70/15	
1.4852 1.4855 1.4857	GX40NiCrNb 35-25 GX30CrNiSiNb 24-24 GX40NiCrSi 35-25	NiCro 70/15*	NiCro 70/15Mn*	
1.4859 1.4861	GX10NiCrNb 32-20 X10NiCr 32-20		NiCro 70/15*	
1.4864 1.4865	X12NiCrSi 36-16 GX40NiCrSi 36-18	NiCro 70/15	NiCro 70/19 NiCro 70/15Mn	
1.4876	X10NiCrAlTi 32-20	NiCro 60/20	NiCro 70/15 NiCro 70/19	
1.4878	X12CrNiTi 18-9	Arosta 309H	Arosta 347	

*for repair welding

COVERED ELECTRODE SELECTION TABLE FOR NICKEL BASE ALLOYS

Material number	EN Code	Electrode type		Remarks
		First choice	Second choice	
Creep resistant chromium-nickel steels				
1.6901 1.6902 1.6905 1.6907	GX8CrNi 18-10 GX6CrNi 18-10 GX5CrNiNb 18-10 X3CrNiN 18-10	NiCro 70/19	-	
Nickel-Copper-Iron-alloys				
2.4360 2.4361 2.4365 2.4375	NiCu30Fe LC-NiCu30Fe G-NiCu30Nb NiCu30Al	NiCu 70/30	-	
Nickel-Chromium-Molybdenum-Iron-Alloys				
2.4602	NiCr21Mo14W (alloy C22)	NiCroMo 59/23 NiCroMo 60/16	-	
2.4605	NiCr23Mo16Al (alloy C59)	NiCroMo 59/23	-	
2.4610	NiMo16Cr16Ti (alloy C4)	NiCroMo 59/23 NiCroMo 60/16	-	
2.4618 2.4619 2.4641	NiCr22Mo6Cu NiCr22Mo7Cu NiCr21Mo6Cu	NiCro 60/20		
2.4816 2.4817	NiCr15Fe LC-NiCr15Fe	NiCro 70/15 NiCro 70/15Mn	NiCro 60/20	
2.4819	NiMo16Cr15W (alloy C276)	NiCroMo 59/23 NiCroMo 60/16	-	
2.4851	NiCr23Fe	NiCro 70/19	NiCro 60/20	
2.4856	NiCr22Mo9Nb	NiCro 60/20	NiCroMo 59/23	NiCroMo 59/23 only higher corrosion resistance
2.4858	NiCr21Mo	NiCro 60/20	-	
2.4867 2.4869 2.4951 2.4952	NiCr60 15 NiCr80 20 NiCr20Ti NiCr20TiAl	NiCro 70/15 NiCro 70/15Mn	-	
2.4975 2.4976	NiFeCr12Mo NiCr20Mo	NiCro 60/20	-	

SELECTION TABLE (Electrodes for dissimilar joints)

GENERAL INFORMATION

Type	EN code	Wirt.	NiCrFe alloys	High temperature CrNi-steel	Stainless CrNiMo-steel	Stainless CrNi-steel	Ferritic Cr-steel	Creep resistant steels with Mo/Cr/MoCr Mo V	C-Mn-steel Yield strength 360-500 N/mm ²	C-steel Yield strength <360 N/mm ²
			NiCr15Fe (Inconel 600) NiCrAlTi (Incoloy 800)	XT5CrNiSi 20 12 XT5CrNiSi 25 20	X5CrNiMo 17-12-2 X2CrNiMo 18-14-3 X10CrNiMoNb 18-12	X5CrNi 18-10 X2CrNi 19-11 X6CrNiNb 18-10	X2Cr13 X6Cr17 X10CrAl24	X20CrMo9-10 X24CrMo9-5 10CrMo9-10 12CrMo9-5	16Mo3	S235-S355 P235-355
Un-alloy steel Re<360N/mm ²	S235-S355 P235-P355		NiCr 70/15 NiCr 70/19 NiCr 70/19	Arosta 309S NiCr 70/15 NiCr 70/19	Nichroma Arosta 309S Arosta 309Mo Arosta 307	Nichroma Arosta 309Mo Arosta 309Mo Arosta 307	Nichroma Arosta 309Mo Arosta 309S Arosta 307	NiCr 70/15 NiCr 70/15Mn NiCr 70/19 NiCr 70/19	Conarc 49C SL 126 SL 206 SL 206 SL 206	Conarc 49C Baso 100 Baso 120
Un-alloy fine grained steel Re<360-500N/mm ²	S420-S500		NiCr 70/15 NiCr 70/15Mn NiCr 70/19 NiCr 70/19	Arosta 309S NiCr 70/19 NiCr 70/19	Nichroma Arosta 309S Arosta 309Mo Arosta 307	Nichroma Arosta 309S Arosta 309Mo Arosta 307	Arosta 309S Arosta 309Mo Arosta 307	NiCr 70/15 NiCr 70/15Mn NiCr 70/19 NiCr 70/19	Conarc 49C SL 126 SL 196 SL 206 SL 206	Conarc 49C SL 126 SL 196 SL 206 SL 206
Mo-alloy steel	16Mo3	1.5475	NiCr 70/15 NiCr 70/15Mn NiCr 70/19 NiCr 70/19	Arosta 309S NiCr 70/19 NiCr 70/19	Nichroma Arosta 309S Arosta 307	Nichroma Arosta 309S Arosta 307	Nichroma Arosta 309S Arosta 307	NiCr 70/15 NiCr 70/15Mn NiCr 70/19 NiCr 70/19	SL 126 SL 196 SL 206 SL 206	SL 126
Cr/Mo MoV creep resistant steel	13CrMo4-5 14MoV63 (DIN)	1.7395 1.7775	NiCr 70/15 NiCr 70/15Mn NiCr 70/19 NiCr 70/19	NiCr 70/15 NiCr 70/15Mn NiCr 70/19 NiCr 70/19	NiCr 70/15 NiCr 70/15Mn NiCr 70/19 NiCr 70/19	NiCr 70/15 NiCr 70/15Mn NiCr 70/19 NiCr 70/19	NiCr 70/15 NiCr 70/15Mn NiCr 70/19 NiCr 70/19	NiCr 70/15 NiCr 70/15Mn NiCr 70/19 NiCr 70/19	SL 196 SL 226 SL 226	SL 196 SL 226
Cr/Mo creep resisting steel	10CrMo9-10 (DIN) 12CrMo9-5 (DIN)	1.7380 1.7362	NiCr 70/15 NiCr 70/15Mn NiCr 70/19 NiCr 70/19	NiCr 70/15 NiCr 70/15Mn NiCr 70/19 NiCr 70/19	NiCr 70/15 NiCr 70/15Mn NiCr 70/19 NiCr 70/19	NiCr 70/15 NiCr 70/15Mn NiCr 70/19 NiCr 70/19	NiCr 70/15 NiCr 70/15Mn NiCr 70/19 NiCr 70/19	NiCr 70/15 NiCr 70/15Mn NiCr 70/19 NiCr 70/19	SL 206 SL 502	SL 206 SL 502
Martensitic Cr-steel	X20CrMoV12-1 (DIN) X24CrMoV12-1 (DIN)	1.4922 1.4936	NiCr 70/15 NiCr 70/15Mn NiCr 70/19 NiCr 70/19	NiCr 70/15 NiCr 70/15Mn NiCr 70/19 NiCr 70/19	NiCr 70/15 NiCr 70/15Mn NiCr 70/19 NiCr 70/19	NiCr 70/15 NiCr 70/15Mn NiCr 70/19 NiCr 70/19	NiCr 70/15 NiCr 70/15Mn NiCr 70/19 NiCr 70/19	NiCr 70/15 NiCr 70/15Mn NiCr 70/19 NiCr 70/19		
Ferritic Cr-steel	X2Cr13 X6Cr17 X10CrAl24 (DIN)	1.4006 1.4016 1.4762	NiCr 70/15 NiCr 70/15Mn NiCr 70/19 NiCr 70/19	Arosta 309S Arosta 309S NiCr 70/15 NiCr 70/15Mn	Nichroma Arosta 309S Arosta 309Mo	Nichroma Arosta 309S Arosta 309Mo	Arosta 309S			
Stainless CrNi-steel	X5CrNi18-10 X2CrNi19-11 X6CrNiNb18-10	1.4301 1.4306 1.4550	NiCr 70/15 NiCr 70/15Mn NiCr 70/19 NiCr 70/19	Arosta 309S NiCr 70/15 NiCr 70/15Mn NiCr 70/19	Arosta 304L Arosta 316L	Arosta 304L Arosta 347	NiCr 70/15 NiCr 70/15Mn NiCr 70/19 NiCr 70/19			
Stainless CrNiMo-steel	X5CrNiMo17-12 X2CrNiMo18-14-3 X10CrNiMoNb18-12 (DIN)	1.4401 1.4435 1.4583	NiCr 70/15 NiCr 70/15Mn NiCr 70/19 NiCr 70/19	Arosta 309S NiCr 70/15 NiCr 70/15Mn NiCr 70/19	Arosta 316L Arosta 316	Arosta 316L Arosta 316	NiCr 70/15 NiCr 70/15Mn NiCr 70/19 NiCr 70/19			
High temperature CrNi-steel	X15CrNiSi20-12 (DIN) X15CrNiSi 25-20 (DIN)	1.4828 1.4841	NiCr 70/15 NiCr 70/15Mn NiCr 70/19 NiCr 70/19	Intherma 310 NiCr 70/15 NiCr 70/15Mn NiCr 70/19						
NiCrFe-alloys	NiCrFeF1(DIN) (Alloy 600) NiCrAlTi (DIN) (Alloy 800)	2.4816 1.4876	NiCr 70/15 NiCr 70/15Mn NiCr 70/19 NiCr 70/19							

Preheating and stress relieving

Preheating 150-250°C

Base material	319.0 333.0 354.0 355.0 380.0	356.0 357.0 359.0 413.0 444.0 443.0	511.0 512.0 513.0 514.0	7005 k 7018 7021 7029 7039 710.0 711.0 712.0	6070	6061 6083 6082 6101 6201 6151 6351 6951	5456	5454	5154 5254 a	5086	5083	5052 5652 a	5005 5050	3004	2219 2519	2014 2036	1100 3003	1060 1070 1080 1350
1060 1070 1080 1350	4145 (c,i)	4043 (i,f)	5356 (c,e,i)	5356 (c,e,i)	4043 (i)	4043 (i)	5356 (c)	4043 (i)	5356 (c,e,i)	5356 (c)	5356 (c)	4043 (i)	1100 (c)	4043	4145	4145	1100	1188
1100 3003	4145 (c,i)	4043 (i,f)	5356 (c,e,i)	5356 (c,e,i)	4043 (i)	4043 (i)	5356 (c)	4043 (e,i)	5356 (c,e,i)	5356 (c)	5356 (c)	4043 (e,i)	4043 (e)	4043 (e)	4145	4145	1100 (c)	
2014 2036	4145 (g)	4145			4145	4145		4043 (i)	4043						4145 (g)	4145 (g)		
2219 2519	4145 (g,c,i)	4145 (g,c,i)	4043 (i)	4043 (i)	4043 (f,i)	4043 (f,i)	4043	4043 (i)	5654 (c,b)	5356 (e)	4043	4043 4043(i)	4043		2319 (c,f,i)			
3004	4043 (i)	4043 (i)	5654 (b)	5356 (e)	4043 (e)	4043 (b)	5356 (e)	5654 (b)	5654 (b)	5356 (e)	5356 (e)	4043 (e,i)	4043 (e)	4043 (e)				
5005 5050	4043 (i)	4043 (i)	5654 (b)	5356 (e)	4043 (e)	4043 (b)	5356 (e)	5654 (b)	5654 (b)	5356 (e)	5356 (e)	4043 (e,i)	4043 (e)					
5052 5652	4043 (i)	4043 (b,i)	5654 (b)	5356 (e)	5356 (b,c)	5356 (b)	5356 (b)	5654 (b)	5356 (e)	5356 (e)	5356 (e)	5654 (a,b,c)						
5083		5356 (c,e,i)	5356 (e)	5183 (e)	5356 (e)	5356 (e)	5183 (b)	5356 (e)	5356 (b)	5356 (e)	5183							
5086		5356 (c,e,i)	5356 (e)	5356 (e)	5356 (e)	5356 (e)	5356 (e)	5356 (b)	5356 (b)	5356 (e)								
5154 5254 a		4043 (b,i)	5654 (b)	5356 (b)	5356 (b,c)	5356 (b,c)	5356 (b)	5654 (a)	5356 (b)	5356 (e)								
5454	4043 (i)	4043 (b,i)	5654 (b)	5356 (b)	5356 (b,c)	5356 (b,c)	5356 (b)	5554 (c,e)	5654 (a,b)									
5456		5356 (c,e,i)	5356 (e)	5556 (e)	5356 (e)	5356 (e)	5356 (e)											
6061 6063 6082 6101 6201 6201 6151 6351 6951	4145 (c,i)	4043 (f,i)	5356 (b,c)	5356 (b,c,i)	4043 (b,i)	4043 (b,i)												
6070	4145 (c,i)	4043 (f,i)	5356 (c,e)	5356 (c,e,i)	4043 (e,i)													
7005 k 7018 7021 7029 7039 710.0 711.0 712.0		4043 (i)	4043 (b,i)	5356 (b)	5356 (i)													
511.0 512.0 513.0 514.0		4043 (b,i)	5654 (b,d)															
356.0 357.0 359.0 413.0 444.0 443.0	4145 (c,i)	4043 (d,i)																
319.0 333.0 354.0 355.0 380.0	4145 (d,c,i)																	

All filler materials are listed in the AWS specification A5.10

- Base metal alloys 5652 and 5254 are used for hydrogen peroxide service, 5654 filler metal is used for welding both alloys for low temperature [150°F [65°C]] service.
- 5183, 5356, 5454, 5754, 5556 and 5654 may be used. In some cases they provide improved color match after anodizing, highest weld ductility and higher weld strength. 5554 is suitable for elevated temperature service.
- 4043 may be used for some applications.
- Filler metal with the same analysis as the base metal is sometimes used.
- 5183, 5356 or 5556 may be used.
- 4145 may be used for some applications.
- 2319 may be used for some applications.
- 4047 may be used for some applications.
- 1100 may be used for some applications.
- This refers to 7005 extrusions only.

Additional Guidelines

- Service conditions such as immersion in fresh or salt water, exposure to specific chemicals, or exposure to sustained high temperature [65°C] may limit the choice of filler metals.
Filler alloys 5356, 5183, 5556 and 5654 are not recommended for sustained elevated temperature service.
- Guide lines in this table apply to gas shielded arc welding processes.
- Where no filler metal is listed, the base metal combination is not recommended for welding

The serviceability of product or structure utilizing this type of information is and must be the sole responsibility of builder/user. Many variables beyond the control of Indalco Alloys affect the results obtained in applying this type of information. These variables include, but are not limited to, welding procedure, plate chemistry and temperature, weldment design, fabrication methods and service requirements

Type	Field of application	Deposit in cm ³ per electrode		
		Ø 3.2	Ø 4.0	Ø 5.0
Ferrod 135T Ferrod 160T	High recovery electrodes for fillet welds and horizontal V- and X-welds. Smooth weld appearance. High welding speed through high recovery of 135, 160 %	4.7	7.1 8.5	11.6 14.2
Ferrod 165A	As Ferrod 160T. Higher welding speed. 160% recovery. Impact properties at -20°C	5.1	8.5	12.7
Universalis	Rutile type, especially for down hand fillet welding and filling in structural steel. Very smooth appearance.	2.7 ¹ 3.5 ²	3.9 ¹ 5.2 ²	
Cumulo	All positions fillet welding and filling f.i. for pipe welding (except vertical-down)	2.5	3.5	
Pantafix	Rutile all position electrode for most widely application. General construction, pipe welding, including vertical-down.	2.4	3.4	
Omnia	General purpose all position electrode. Low open circuit, small diameters for hobby market.	2.4/2.4	3.4/3.4	
Supra	All position rutile, excellent vertical down properties. Shipbuilding repairs.	2.4	3.3	4.9
Kardo	Basic electrode, low yield, low tensile, high impact.	3.0	4.4	
Baso 48SP	Rutile-basic electrode, excellent weldability, start and restart.	3.0	5.3	
Baso 100	Basic electrode for welding under difficult conditions	2.5 ¹	3.7 ¹	8.0
Baso 120	Basic electrode, 120% efficiency, for fast filling in all positions in difficult construction work	2.9 ¹ 3.9 ²	4.0 ¹ 5.8 ²	9.1
Baso G	Basic DC(arc) electrode, 120% efficiency, for fast filling in all positions.	3.0 ¹ 3.9 ²	4.5 ¹ 5.8 ²	9.1
Conarc 48	Basic electrode, 130% efficiency, Very good notch toughness at low temperatures.	3.2 ¹	4.9 ¹ 6.1 ²	
Conarc 49C	Basic electrode, 115% efficiency. Very good notch toughness at low temperatures.	2.8	4.2 ¹ 6.1 ²	8.5
Baso 26V	Basic electrode for vertical-down welding	2.7	5.3	8.5
Conarc 51	Basic electrode. All positions. Very good notch toughness at low temperatures	2.2	3.4	9.8
Conarc L150	Basic electrode for horizontal fillet welds and filling. 150% efficiency	4.9	7.5	11.6
Conarc V180	Basic electrode with approx. 175% efficiency for high deposition rate downhand filling.	6.1	9.1	12.7

All information in this data sheet is accurate to the best of our knowledge at the time of printing. Please refer to www.lincolnelectric.eu for any updated information. Fumes: Safety Data Sheets (SDS) are available on our website.

Arc time in seconds per electrode		
Ø 3.2	Ø 4.0	Ø 5.0
75	65	68
85	92	86
90	90	78
57 ¹ 69 ²	55 ¹ 69 ²	
66	62	
66	72	
59/65	59/72	
64	66	77
84	79	
75	95	
62 ¹	64 ¹	91
62 ¹ 74 ²	63 ¹ 85 ²	99
70 ¹ 79 ²	75 ¹ 96 ²	114
67 ¹	83 ¹	95 ²
65	75 ¹ 100 ²	90
51	70	86
62	71	104
84	80	75
73	70	75
	70	75

Weld metal volume per meter

Fillet size "a" in mm	Theoretical content in cm ³	Formula : (a ² x L) "a" in mm
3	9	
3.5	12.3	
4	16	
4.5	20.3	
5	25	
5.5	30.3	
6	36	
8	64	
10	100	

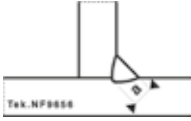

Thickness "t" in mm	Theoretical content in cm ³			Formula : V50° : d [0.466d + v] L V60° : d [0.577d + v] L V70° : d [0.700d + v] L
	V50°	V60°	V70°	
6	35	39	43	
8	54	61	69	
10	77	88	100	
12	103	119	137	
14	133	155	179	
16	167	196	227	
18	205	241	281	
20	246	291	340	

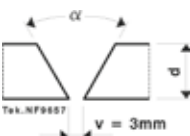

Thickness "t" in mm	Theoretical content in cm ³			Formula : X50° : d [0.233d + v] L X60° : d [0.228d + v] L X70° : d [0.350d + v] L
	V50°	V60°	V70°	
14	88	98	111	
16	108	122	138	
18	129	147	167	
20	153	175	200	
25	220	255	294	
30	300	349	405	
35	390	458	534	
40	493	581	680	



Thickness "t" in mm	Theoretical content in cm ³	Formula : ((d-10) ² x 0,27 + 12d - 73)
20	194	
25	288	
30	395	
35	516	
40	650	

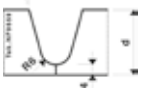

DETERMINATION OF WELDING COSTS

weld content deposit per electrode	=	number of electrodes
price per electrode x number	=	costs of electrodes
number of electrodes x arc time	=	total arc time
total arc time x100 percentage duty cycle	=	total work time
total work time x hourly wage	=	wage costs
costs of electrodes + wage costs	=	total costs

Note: the percentage of duty cycle depends on practical conditions, and may vary between 15-45%
1) L = 350mm 2) L = 450mm

Ferrite Number

To facilitate international communication (specifications, certifications), the internationally accepted term Ferrite Number (FN) has been introduced to indicate a delta-ferrite content in stainless steel weld metal.

The Ferrite Number is often used as an indicator of resistance to weld metal hot cracking. This aspect and other engineering properties have been correlated with the FN value of the weld metal. For various service conditions the following typical levels reflect good experiences:

- fully austenitic weld metal:
 - high corrosion resistance in severe oxidising and reducing acidic and chloride containing media: FN < 0.5
 - fully austenitic CrNiMoN weld metal, non-magnetic: FN < 0.5
- low ferrite CrNiN and CrNiMoN weld metal, cryogenic applications: FN 3-6 or < 0.5
- general purpose stainless steel weld metal with corrosion resistance and high resistance to hot cracking and microfissures: FN 6-15
- buffer layer of austenitic/ferritic weld deposits for dissimilar joints and buffer layers in clad steel: FN 15-35
- austenitic/ferritic weld metal with high stress and pitting corrosion resistance as well as a balanced structure for toughness and corrosion: FN 30-70

Control of welding of constructions often requires the determination of the Ferrite Number (FN).

Ferrite Measurement

An internationally accepted standardised method to determine the ferrite content is based upon an arbitrarily defined relationship between a magnetic force and weld ferrite content. This is necessary because an absolute and correct determination of the ferrite content is not available as a result of inherent inaccuracy of metallographic examination and the nonexistence of a calibration method for the absolute ferrite content in stainless steel. The attracting force between a defined permanent magnet and weld metal, containing delta-ferrite is measured by means of a torsion balance. The values are in fact compared with the values obtained in measurements using the same magnet, attracting a carbon steel base plate with a non magnetic copper coating of a specified thickness. A calibration method provides the necessary linear relation. The principles are accepted as the international standard ISO 8249 and AWS A4.2-91. The European Standardization will adopt the ISO standard.

The range in the revised standards has been extended to 100FN (originally 0-28FN).

Coated thickness standards are available from the "U.S. National Institute of Standards and Technology" (NIST). A precision torsion balance or the commercially available "Magne Gage" (fig.3) are suitable for the determination of the Ferrite Number under laboratory conditions (horizontal position). A permanent magnet of defined dimensions and magnetic strength, according ISO 8249, shall be used.

Secondary standards for the checking and calibration of field equipment in the range 0-100FN are available from NIST.

Calculation of ferrite content

The ferrite content is estimated on the basis of calculation, using the as deposited weld metal chemical composition. The Cr- and Ni-equivalent is plotted in diagrams, based on the metallographic studies, such as:

- the Schaeffler Diagram¹, published in 1949, is considered as most suitable for a general picture of weld metal structures for a wide range of compositions, but not accurate for ferrite containing austenitic weld metals;
- the DeLong Diagram [1973]², widely used up to 1985, for a limited range of CrNi (Mo, N)-stainless steel weld metal grades;
- the WRC 1992 Constitution Diagram [1992], published by Kotecki and Siewert [1992]³ has been based upon the WRC 1988 Constitution Diagram, earlier published by Siewert, McCowan and Olson⁴ as a result of a review and of more than 950 weld metal sample analyses and FN determinations (including data from Lincoln Electric). For this diagram, a better accuracy has been reported due to the accurate determination of the effect of Mn, Si, C, N and Nb.
- Also reference is made to the ESPY Diagram⁵ for the calculation of the ferrite content.

Application of Ferrite Diagrams

The various ferrite diagrams are suitable to estimate the Ferrite Number in weld metal. Ongoing verifications indicate that the new WRC 1992 Constitution Diagram provides the best estimate. The old Schaeffler diagram still provide useful information in a wide range of weld metal compositions. It provides guidelines for dissimilar joints and welding clad steel, calculation of composition and position of the diluted weld metal.

The following pages contain a reprint of a combination of the Schaeffler and the WRC 1992 Constitution Diagram (fig. 1) and the standard WRC 1992 Constitution Diagram on full scale (fig. 2). In using these diagrams for the estimation of weld metal structure, one should always take into account the effects of different welding conditions (temperature/time-cycles, welding parameters, surface effects) which usually influence FN values, compared with measurements on all weld metal deposit samples.

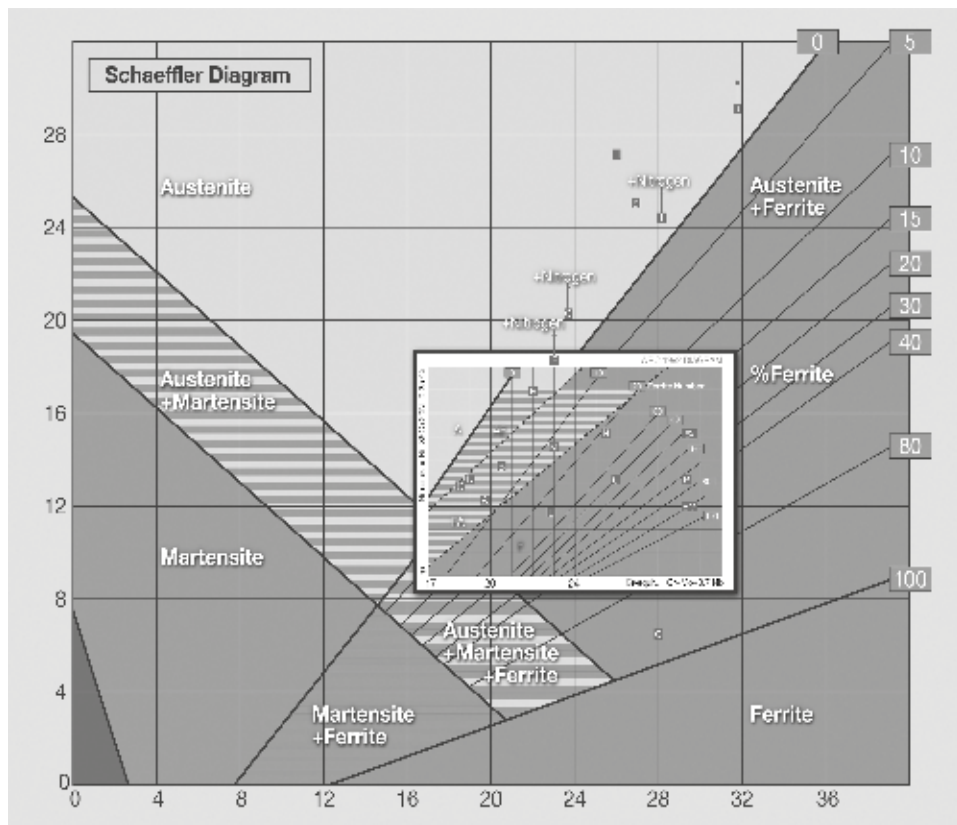

Fig. 1 Combined Schaeffler / WRC 1992 Constitution Diagram

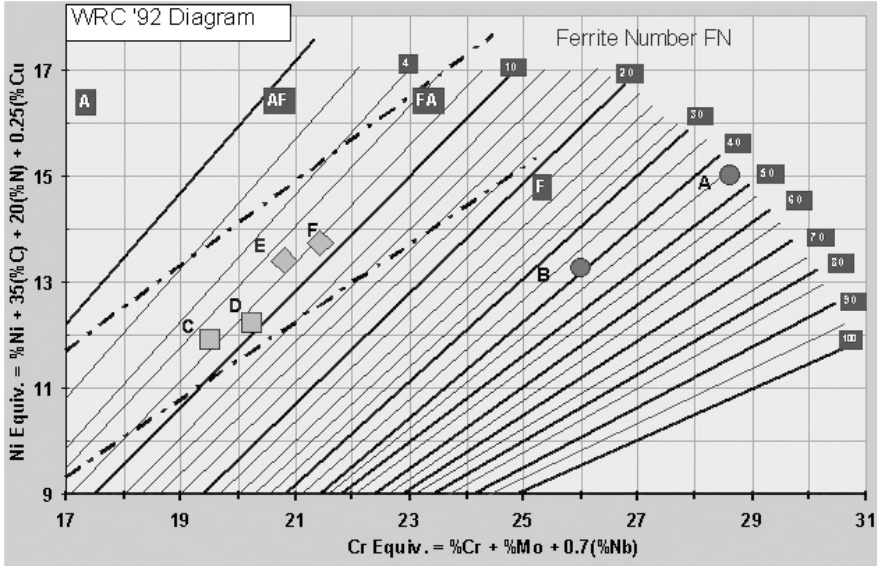

Fig. 2 WRC 1992 Constitution Diagram

Position of welding consumables

The position of representative Lincoln Electric Europe welding consumables (table 1) has been marked in the combined Schaeffler-WRC 1992 Diagram (figure 1) and in the original WRC Diagram.

Table 1 Cr- and Ni-equivalent, calculated according Schaeffler and the WRC'92 Constitution Diagram

Ident	Product	WRC'92		Schaeffler		ident	Product	WRC'92		Schaeffler	
		Cr-eq	Ni-eq	Cr-eq	Ni-eq			Cr-eq	Ni-eq	Cr-eq	Ni-eq
A	Jungo Zeron® 100X	28.6	15.0	29.1	10.5	I	Jungo 4500	25.0	27.3	26.4	26.2
B	Jungo 4462	26.0	13.3	26.9	10.9	J	Jungo 4465	27.2	25.7	28.1	25.2
C	Arosta 304L	19.5	11.9	20.6	11.0	K	NiCro 31/27	30.5	33.2	31.7	32.0
D	Arosta 347	20.3	12.2	21.4	11.3	L	Arosta 309S	23.6	14.2	24.6	13.3
E	Arosta 316L	20.8	13.4	22.0	12.5	M	Arosta 309Mo	25.4	14.5	26.7	13.5
F	Arosta 318	21.5	13.8	22.7	12.8	N	Arosta 307	17.8	13.3	18.7	14.2
G	Arosta 4439	22.6	21.3	23.8	18.2	O	Arosta 329	25.4	8.6	27.2	7.4
H	Jungo 4455	23.0	19.9	23.5	20.3	P	Limarosta 312	28.8	13.9	30.3	12.7

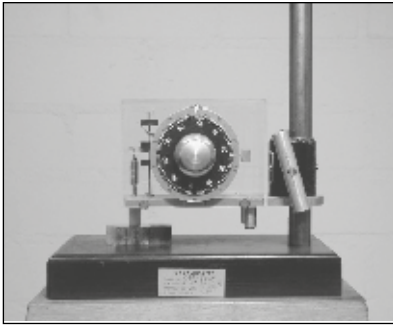

Fig. 3 Magne Gage

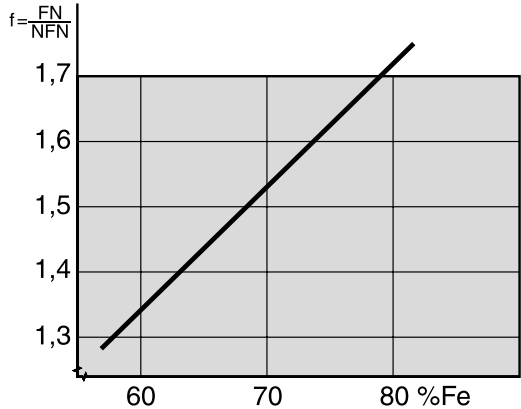

Fig. 4 Iron content versus factor f

Ferrite Number versus Ferrite Content

The Ferrite Number is not equal to the volumetric ferrite content (%). Although an absolute ferrite content can not be measured accurately, a reasonable estimate of the ferrite content can be made by dividing the Ferrite Number by the factor f (% ferrite = FN / f) which is dependant of the iron content in the weld metal as shown in figure 4.

Limitations

With the practice of measuring the Ferrite Number or ferrite content, welding conditions deviating from the standardised conditions have always to be taken into account. Furthermore, comparison tests showed that the accuracy between measurements in various laboratories may show differences up to +/- 10%.

Lincoln Electric laboratories

Since 1966 the Lincoln Electric and Lincoln Smitweld R&D departments have always been involved in the international development of ferrite determinations. The laboratories are equipped with calibrated Magne Gages and on site measurement equipment. Primary coating thickness standards and secondary standards are available for contract calibration work.

References

- 1) Schaeffler A.E., Metal Progress 56 (1949) p680-680s
- 2) DeLong W.T., Welding Journal 53 (1974) p273s-286s
- 3) Kotecki D.J., Siewert T.A., Welding Journal (1992) p171s-178s
- 4) Siewert T.A., McCowan C.N., Olson D.L., Welding Journal (1988) p289s-298s
- 5) Espy R.H., Welding Journal 61 (1982) p149s-156s

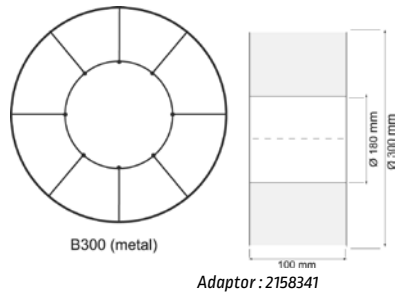
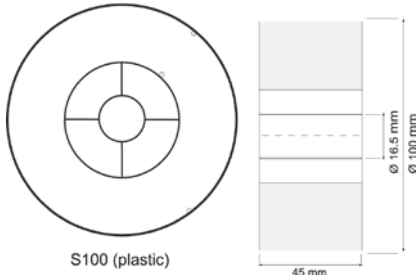

Adaptor : 2158341

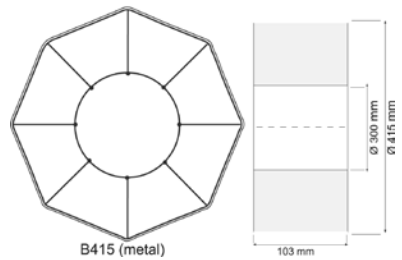
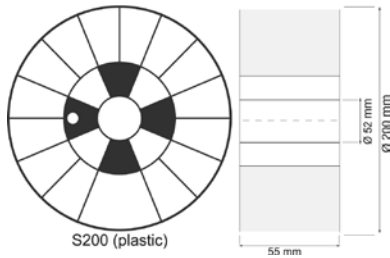

Adaptor : K299 (axis 25mm)
K1504-1 (axis 50mm)

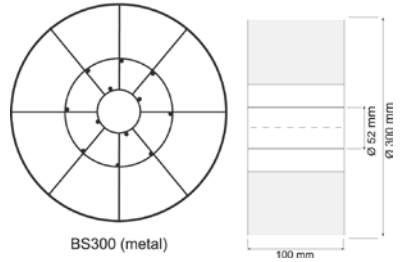
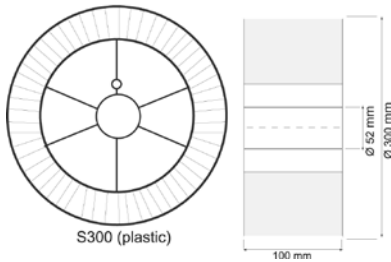

Adaptor : K10158
K10158-1 (plastic)

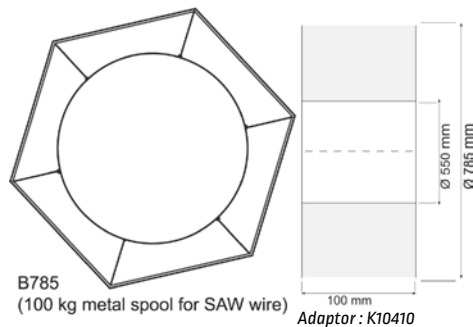

Adaptor : K10410

AccuTrak® EcoDrum

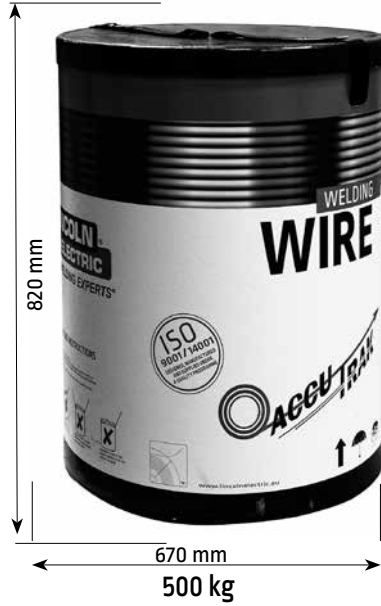

Advantages

- No tangles, tens of thousands of drums made.
- "Integral lifting straps" for crane or fork lift handling.
- No plastic hoods needed eliminating expensive accessories.
- Rigid cardboard construction.
- "Retaining ring" specifically designed for easy pay off.
- Drum is completely recyclable, no metal or plastic parts.

Gem-Pak™



Advantages

- Tangle Free - Prevents tangling and improves feedability
- Easy to Set-up - No external payoff devices required.
- Corrugated Cardboard Pallet - Fork-lift ready mini-pallet comes attached to the box for maximum portability and is 100% recyclable.

Wire Capacity (kg) : 125/136
 Wire diameters (mm) : 0.9 - 1.2 - 1.6
 Wire grade : 4043 (AlSi5), 5356 (AlMg5), 5356TM (AlMg5Cr),

AccuTrak® drums 600 & 1000 kg capacity

Product	Dimensions (HxWxL mm)	Wire capacity (kg)	Wire size (mm)	Wire grade
ACCUTRAK 600KG	1051 x 720 x 720 including pallet	600	1.6 to 2.4	Non & low alloy steels
ACCUTRAK 1000KG	1000 x 1000 x 1000 including pallet	1000	1.6 to 4.0	

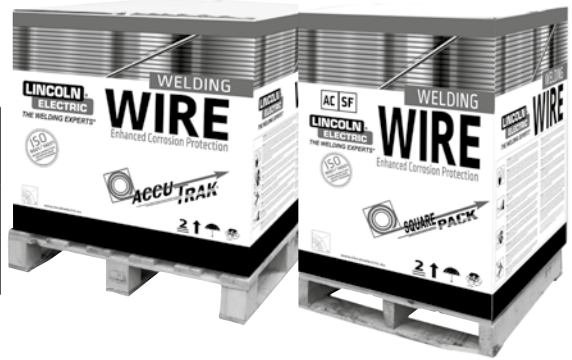

Speed-Feed drums 350, 400 & 600 kg capacity



Product	Wire capacity (kg)	Dimensions (mm)	Drums/ Pallet	Wire size (mm)	Wire grade
SPEED FEED DRUMS	350	Drum (ø x H) : 546x906 Pallet (H x W x D) : 1140x1140x1070	4	1.6 to 4.8	Non & low alloy steels
	400	Drum (ø x H) : 571x906 Pallet (H x W x D) : 600x1200x1050	2		
	600	1051x720x720 including pallet	1		

1000 kg coil

Wooden reel



Wire capacity (kg)	Dimensions ø x H (mm)	Quantity/ Pallet	Wire size (mm)	Wire grade
300	750 x 290	3	2.0 to 4.8	Mild, low alloy & stainless steels

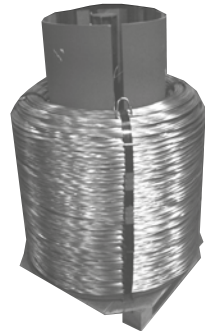

Wire capacity (kg)	Dimensions ø x H (mm)	Quantity/ Pallet	Wire size (mm)	Wire grade
1000	900 x 1100	1	2.4 to 4.8	Mild, low alloy & stainless steels

Sahara ReadyPack®: Warehouse and quiver in pocket format

Electrodes in Sahara ReadyPack® really save time and money. For these electrodes there is no need to store in a conditioned warehouse or to use redry ovens and quivers. This innovation on an industrial scale has been a success for many years now. Millions of the well known Sahara ReadyPack® have been consumed in ship building, chemical industry and in offshore projects. The moisture resistant vacuum packaging fits well with the advantages of the remarkable EMR-Sahara® concept. EMR-Sahara® covered electrodes are designed to be low in moisture and show a very low moisture absorption. The internationally (IIW) agreed moisture resistance test demonstrates that the electrodes remain, after exposure during 24 hours at 27°C and 70% R.H., below a maximum hydrogen content of 5 ml/100g which is the criterium to call the electrodes MR: moisture resistant. Even more important is the fact that the electrodes can be consumed from an opened Sahara ReadyPack® within 12 hours, and still prove to produce a weld deposit with a very low in hydrogen content (HDM < 5 ml/100g). For a number of EMR-Sahara® electrodes the maximum HDM level is even 3 ml/100g.

A Sahara ReadyPack® actually replaces the functions of a conditioned warehouse and a redry oven, all in pocket format. Storage in a conditioned warehouse is no longer needed; most efficient is a small storage room at the job site. The use of a redry oven is not recommended. Up to the moment you open the Sahara ReadyPack®, and during the following period of 12 hours, EMR-Sahara® electrodes keep their initial quality. The convenient packages are easily carried to the welding place. The content of one or two package is usually good for one working day. A real cost saving is demonstrated in many cases, mainly because maintenance of quivers and quality control on redrying procedures is no longer needed. Not to mention the loss of unproductive time in transportation from the redry oven to the job site. The reliable Sahara ReadyPack® has indeed set a trend in the welding industry.

Properties of the Sahara ReadyPack® and its content, the EMR-Sahara® [basic] electrodes in summary:

- Diffusible hydrogen level HDM less than 5 ml/100g; a new generation provides even less than 3 ml/100g
- Low moisture pick-up of the EMR-Sahara electrode coating; 12 hours after opening of the Sahara ReadyPack® still provides electrodes with a hydrogen content of maximum 5 and 3 ml/100g respectively
- Storage does not need a conditioned warehouse
- Intermediate storage in a dry cabinet or quiver is not needed, even not recommended
- No mix-up of electrodes, as may happen with electrodes outside the packaging for redrying
- A most efficient handling procedure; cost savings can easily be calculated.

The range of electrodes in the Sahara ReadyPack®

Currently the following moisture resistant very low hydrogen electrodes [basic EMR-Sahara® electrodes] can be supplied in Sahara ReadyPack®:

Type	H _{DM} max. 5 ml/100 g	H _{DM} max. 3 ml/100 g
Baso G		*
Conarc 49C		*
Conarc 51		*
Conarc L150	*	
Conarc V180		*
Kardo		*
Conarc 55CT		*
Conarc 60G		*
Conarc 70G		*
Conarc 80		*
Conarc 85		*
SL12G	*	
SL19G	*	
SL20G	*	
SL22G	*	
SL502	*	
SL9r(P91)	*	

Type	H _{DM} max. 5 ml/100 g	H _{DM} max. 3 ml/100 g
Kryo 1		*
Kryo 1P		*
Kryo 1-180		*
Kryo 2		*
Kryo 3		*
Kryo 4		*
Arosta 304L		
Arosta 316L		
Arosta 4462		
Jungo 4462		
Limarosta 304L		
Limarosta 309S		
Limarosta 312		
Limarosta 316L		
Limarosta 316L-130		
Nyloid 2		

1. Scope

Covered arc welding electrodes, manufactured by Lincoln Electric Europe, delivered in their original packaging.

The packaging consists of either:

- A** cardboard boxes in outer carton;
- B** foil protected cardboard boxes in outer carton;
- C** plastic (PE) boxes with sealed cap, suitable for reclosing;
- D** hermetically sealed metal tin (LINC CAN™) in outer carton;
- E** hermetically vacuum sealed foil packs (MINI-PACK) in outer carton;
- F** hermetically vacuum sealed foil packs (Sahara ReadyPack®) in outer carton.

Electrode grades	Packaging type					
	A	B	C	D	E	F
Mild steel	X	X	X	X		X
Low alloy high strength steel		X		X		X
Low temperature fine grain steel		X		X	X	X
Creep resistant steel		X				X
Stainless steel		X	X	X	X	X
Duplex and Superduplex stainless steel		X				X
Nickel base electrodes			X			X
Hardfacing-, maintenance and repair electrodes			X			

2. Storage

2a. Storage of electrodes in cardboard boxes requires humidity and temperature controlled storage areas.

General recommended storage conditions include:

- temperature 17-27°C, relative humidity ≤60%
- temperature 27-37°C, relative humidity ≤50%.
- electrode boxes may be stored in layers to a maximum of 7.

2b. Plastic boxes require storage conditions suitable to cardboard boxes

2c. No temperature and humidity requirements are applicable for electrodes in Linc-Can Mini-Pack and Sahara ReadyPacks, providing that (vacuum) seal is present in undamaged packs.

General recommended storage conditions include:

- Sahara ReadyPacks & Mini-Pack in outer cartons may be stored in layers to a maximum of 7;
- Linc Can in outerboxes may be stored in layers to a maximum of 5;
- Prevent damage and heating above 60°C for Linc-Can and Sahara ReadyPacks;
- Prevent damage and heating above 40°C for Mini-Pack.

3. Handling

3a. Re-drying and subsequential holding, as recommended in table 1, is required for products in the following conditions

- rutile electrodes, being humidified for any reason;
- basic low hydrogen electrodes in cardboard boxes;
- basic low hydrogen electrodes, returned from shop floor or damaged Sahara ReadyPacks, Mini-Pack or Linc Can;
- stainless steel and Ni-base electrodes after long and unknown storage conditions (deviating from recommendations);
- Wearshield electrodes in plastic (PE) boxes, stored for more than 1 year under conditions as described under section 2a. or earlier when the condition deviates from those recommended.

3b. Electrodes in Sahara ReadyPack and Linc-Can can be used without re-drying, providing that vacuum or seal is present in the undamaged packaging. The electrodes can be consumed in the as received condition, direct from the packaging within a period of 8 hours after opening under the conditions of ≤35°C and ≤90% RH, with the electrodes remaining in the opened packaging and protected against excessive conditions as condensation, rain, etc. This time can be extended to 12 hours under the conditions of ≤27°C and ≤70% RH. Once opened Linc-Cans should be closed during welding operations using the plastic lid that is supplied with the tin. If vacuum or seal is not present, the electrodes shall follow the re-dry and holding procedure as recommended in table 1 for the EMR-Sahara® Range. Electrodes in Mini-Pack can be used without re-drying, provided that the vacuum is present in the undamaged packaging. The electrodes can be consumed in the as received condition, direct from the packaging within a period of 4 hours after opening under the conditions of ≤35°C and ≤90% RH, with the electrodes remaining in the opened packaging and protected against excessive conditions as condensation, rain, etc

REDRYING AND HOLDING RECOMMENDATIONS

Covered electrodes that have suffered from serious water and moisture contamination, or have been exposed to the atmosphere over long periods of time cannot be restored in their original condition and should be discarded.

Electrode product groups	Re-drying Time (h)*	Temp [°C]	Holding
Mild steel: - rutile E6013 - rutile E6012, E7024	0.5-1h 1-2h	70-80 100-120	Cabinet 10-20°C above ambient temperature
- basic low hydrogen (HDM <8 ml/100g) - basic very low hydrogen*	2-6h 2-6h	250-375 325-375	a. Holding oven max. one year at 120-180°C b. Quiver max. 10h at RT-125°C (see illustration fig. 1) c. Plastic (PE) box max. 2 weeks workshop conditions
Low alloy: - basic very low hydrogen**	2-6h	325-375	
Hardfacing-; maintenance & repair electrodes			
Stainless steel: - non EMR-SAHARA electrodes - EMR-SAHARA range	1-6h 1-6h	200-300 125-300	Holding oven unlimited time at 75-125°C quiver max. 10h at RT-125°C
Ni-base	1-6h	200-300	

* Re-drying can be repeated twice within the indicated max. time of 6h. Re-drying of electrodes should be carried out by taking them out of the packaging and place the electrodes in approx. 3 cm thick layers in a temperature controlled air-circulation oven.

** If these EMR-SAHARA electrodes are redried a maximum content HDM of ≤5ml/100g is valid.

Figure 1:

Recommended handling procedure of EMR-SAHARA® electrodes after removal either from a regular cardboard box or vacuum sealed Sahara ReadyPack®

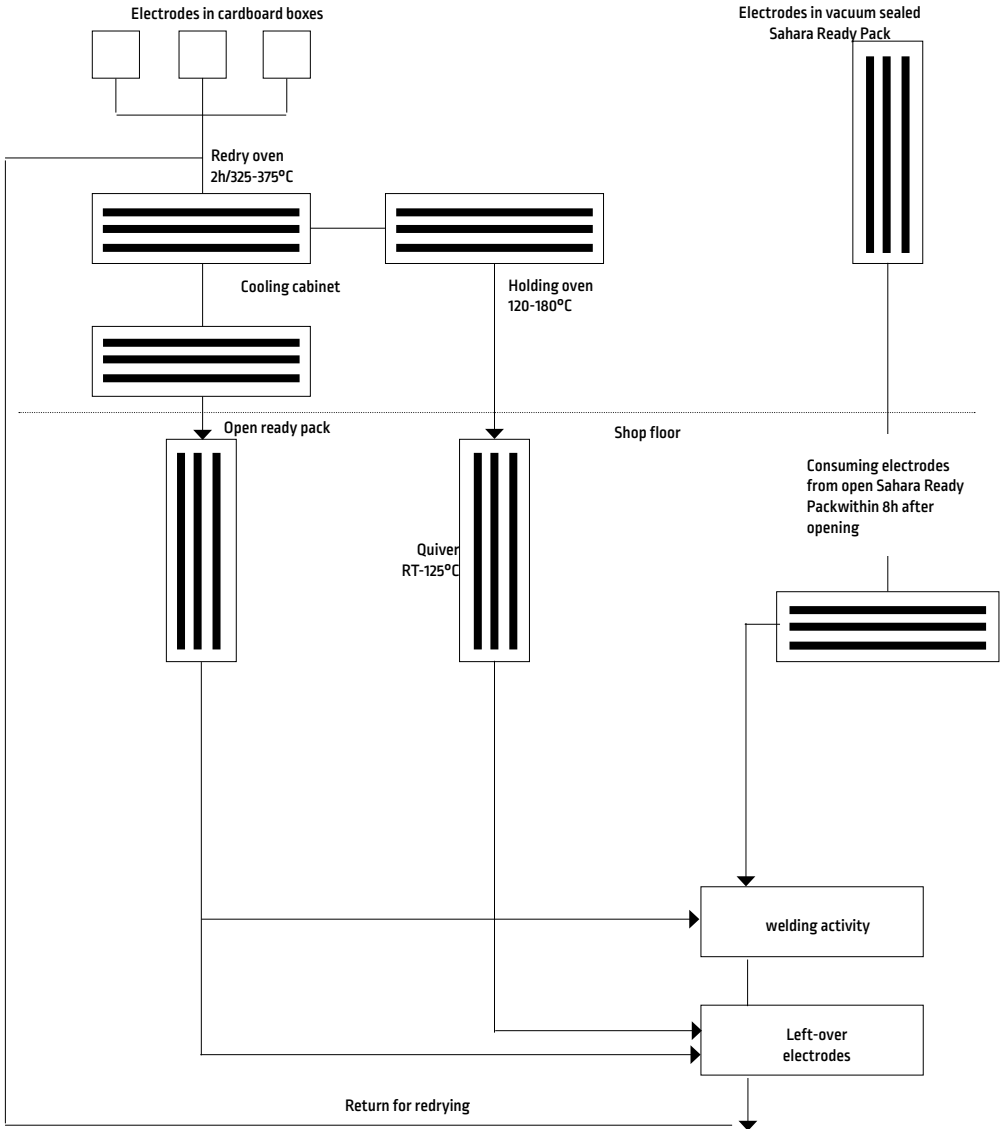

FLUX-CORED WIRES**1. Scope**

Tubular cored wires with the following trade names are supplied in various spooling and packaging:

Product family	Packaging
OUTERSHIELD®	- spool in plastic bag in cardboard box - spool in Al/PE vacuum packaging in cardboard outerbox or - spool in plastic protection on pallet - Accutrack® drums
INNERSHIELD® /LINCORE®	spool in cardboard box or plastic bucket or hermetically sealed cans
COR-A-ROSTA®	spool in Al/PE vacuum bag in cardboard box

2. Storage

Exposure to a humid environment with only a relative thin plastic foil shall be prevented.

Tubular wire, packed in the original foil and cardboard box or drum require controlled warehouse conditions such as:

- temperature 17-27°C, relative humidity: ≤60%;
- temperature 27-37°C, relative humidity: ≤50%.

INNERSHIELD wires in plastic buckets or in hermetically sealed cans and OUTERSHIELD as well as COR-A-ROSTA in Al/PE bags under vacuum, if applicable, do not require measures against moisture pick-up. Damage of the packaging shall be prevented..

3. Handling

3a. Outershield, Innershield xxx-H types and Cor-A-Rosta

Spools outside the protective packaging allow exposure to normal workshop conditions during ≤72 hours.

Drums fitted with the original lid or recommended drum hood allow exposure to normal workshop conditions during 2 weeks

3b. Innershield, non xxx-H types:

Spools outside the protective packaging allow 2 weeks exposure to normal workshop conditions

In all cases the products require protection against contamination with moisture, dirt and oil products. During interruption of the production process for more than 8 hours, wire spools shall be stored in their plastic bag in the above-mentioned storage conditions

4. Deteriorated product

Cored electrode products that are rusty, have suffered from serious water and moisture contamination, or have been exposed to the atmosphere over long periods of time cannot be restored in their original condition and should be discarded.

MIG WIRES & TIG RODS**1. Scope**

Solid wires and rods can be supplied in various packaging units in tubes, spools and drums

2. Storage

Exposure to a humid environment shall be prevented.

The following storage conditions are recommended.

Solid wire in the original packaging require controlled warehouse conditions such as:

- temperature 17-27°C, relative humidity ≤60%
- temperature 27-37°C, relative humidity ≤50%

3. Handling

Rods and spools outside the protective packaging allow 2 weeks of exposure to normal workshop conditions.

In all cases, the products require protection against contamination with moisture, dirt and oil products.

During interruption of the production process for more than 8 hours, wire spools shall be stored in their plastic bag in the above mentioned storage conditions.

Damage of packaging should be avoided

4. Deteriorated product

Products that are oxidized, have suffered from serious water and moisture contamination, or have been exposed to the atmosphere over long periods, cannot be restored in their original condition and should be discarded.

1. Scope

Trade name: 761, 780, 781, 782, 802, 839, 842-H, 860, 880, 882, 888, 960, 980, 995N, 998N, 8500, P223, P230, P240, P2000, P2007, P2000S, SPX-80X, WTX, 708GB.

Packaging: plastic bags, bulk bag, sealed metal drums and Sahara ReadyBag™

2. Storage

The following storage conditions are recommended:

Welding fluxes, packed in plastic bags, require controlled warehouse conditions such as:

- temperature 17-27°C, relative humidity: ≤60%

- temperature 27-37°C, relative humidity: ≤50%

Product in metal drums does not require special storage conditions but rust and damage of the packaging shall be prevented.

3. Handling

Product characteristics as specified for the original condition, are retained if the product is treated in accordance with the following recommendations:

Packaging	Storage conditions	
	0-6 months, temperature ≤37°C or rel. humidity <50%	>6 months or temperature >37°C or relative humidity 50-90%*
Plastic bags	use as is**	redry 1-2h / 300-375°C
Sahara Ready Bag	use as is	use as is
Metal drums	use as is	use as is

* if storage conditions include a relative humidity over 90% the flux may have been deteriorated so that re-drying becomes ineffective.

** if a severe application is considered (HAZ or weld metal hardness HV10 >350, heavy restraint, etc.) re-drying 1-2h / 300-375°C is recommended.

Re-drying is carried out with the product removed from the original packaging and treated in an oven with an even temperature. It is recommended to have either an oven atmosphere circulation over a maximum flux height of 3 cm or to have the flux moving.

The re-drying operation can be repeated to a maximum of 4 times.

Redried flux and flux handled in the welding operation, shall be kept dry, preferably at a temperature of 50-120°C above ambient temperature, time unlimited.

4. Deteriorated product

Welding fluxes that have suffered from serious water and moisture contamination, or have been exposed to the atmosphere over long periods of time cannot be restored in their original condition and should be discarded

5. Recycling

Non consumed flux collected from the weld shall be cleaned from slag, metal and/or other contamination. Damage of the flux by heavy impingement in the transport system shall be prevented. Prevent separation of the different grain fraction in cyclones or in "dead" corners. Add new flux in the hopper in a circulation system before a level of 25% of the full hopper is reached.

STICK ELECTRODES

Mild and Fine Grained Steel.....	
Fleetweld® 5P+	64
Supra®	66
Omnia®	68
Pantafix®	70
Omnia® 46	72
Numal	74
Cumulo®	76
Universalis®	78
Rental	80
Ferrod® 165A	82
Ferrod® 135T	84
Ferrod® 160T	86
Gonia 180	88
Baso® 48SP	90
Basic 7018	92
Baso® 51P	94
Lincoln 7016 DR	96
Baso® 100	98
Baso® 120.....	100
Baso® 6.....	102
Baso® 26V.....	104
Vandal.....	106
Conarc® 48.....	108
Conarc® 49.....	110
Conarc® 49C.....	112
Conarc® One.....	114
Conarc® 50	116
Conarc® 51	118
Conarc® 52	120
Lincoln 7018-1.....	122
Conarc® L150	124
Conarc® V180.....	126
Kardo	128

Low Alloy Steel	
Shield Arc® HYP+.....	130
Shield Arc® 70+.....	132
Conarc® 55CT	134
Conarc® 60G.....	136
Conarc® 70G	138
Conarc® 74	140
Conarc® 80	142
Conarc® 85.....	144
Kryo® 1.....	146
Kryo® 1N	148
Kryo® 1P	150
Kryo® 1-145.....	152
Kryo® 1-180.....	154
Kryo® 2	156
Kryo® 3	158
Kryo® 4	160

SL®12G	162
SL®19G	164
SL®20G	166
SL®22G	168
SL®502.....	170
SL®9Cr[P91]	172

Stainless and Heat Resistant Steel	
Arosta® 304L	174
Limarosta® 304L	176
Vertarosta® 304L	178
Jungo® 304L	180
Arosta® 347	182
Jungo® 347.....	184
Arosta® 316L.....	186
Limarosta® 316L.....	188
Vertarosta® 316L.....	190
Jungo® 316L	192
Limarosta® 316L-130	194
Arosta® 318.....	196
Jungo® 4465	198
Jungo® 4500	200
Arosta® 4462	202
Jungo® 4462	204
Jungo® 309L	206
Arosta® 309S.....	208
Limarosta® 309S.....	210
Arosta® 309Mo.....	212
Nichroma	214
Nichroma 160	216
Limarosta® 312.....	218
Arosta® 307	220
Arosta® 307-160	222
Jungo® 307.....	224
Arosta® 304H.....	226
Arosta® 309H	228
Intherma® 310	230
Intherma® 310B.....	232
Lincox P 308L	234
Lincox 308L	236
Lincox P 316L	238
Lincox 316L	240
Lincox P 309L	242
Lincox 309L	244

Nickel alloys	
NiCro 31/27	246
NiCro 60/20	248
NiCro 70/15.....	250
NiCro 70/15Mn	252
NiCro 70/19.....	254
NYLOID 2.....	256
NYLOID 4.....	258

Aluminium Alloys	
AlMn.....	260
AlSi5	262
AlSi2	264

Hardfacing Applications	
Wearshield® BU-30.....	266
Wearshield® Mangjet (e)	268
Wearshield® 15CrMn.....	270
Wearshield® MM 40	272
Wearshield® MM.....	274
Wearshield® T&D.....	276
Wearshield® MI (e)	278
Wearshield® ABR.....	280
Wearshield® ME (e)	282
Wearshield® 60 (e)	284
Wearshield® 70	286
Wearshield® 420	288

Cast Iron	
RepTec Cast 1.....	290
RepTec Cast 3	292
RepTec Cast 31	294

Kryo® 1-145

Up to 145% recovery
stick electrode for offshore platforms



Fleetweld® 5P+

SMAW

CLASSIFICATION

AWS A5.1	E6010	A-Nr	1
ISO 2560-A	E 42 3 C 2 5	F-Nr	3
		9606 FM	1

GENERAL DESCRIPTION

Cellulosic coated electrode for pipe and general welding
 Gives high ductility root welds
 Very deep penetration ensures sound root pass
 Easy striking, easy slag release
 High volume of generated gas eliminates porosity
 Reduces problems from dirt and oil on surface

WELDING POSITIONS (ISO/ASME)



PH/5Gu



PJ/5Gd

CURRENT TYPE

DC +

APPROVALS

ABS

+

CHEMICAL COMPOSITION (W%), TYPICAL, ALL WELD METAL

C	Mn	Si
0.20	0.56	0.17

MECHANICAL PROPERTIES, TYPICAL, ALL WELD METAL

	Condition	Yield strength (N/mm ²)	Tensile strength (N/mm ²)	Elongation (%)	Impact ISO-V(J)
					-29°C/-30°C
Required: AWS A5.1	AW	min. 330	min. 430	min. 22	min. 27
ISO 2560-A		min. 420	500-640	min. 20	min. 47
Typical values		471	586	24	56

PACKAGING AND AVAILABLE SIZES

	Diameter (mm)	2.5	3.2	4.0	5.0
	Length (mm)	350	350	350	350
Linc Can™	Pieces / unit	304	180	130	83
	Net weight/unit (kg)	5.1	4.7	5.1	5.1

Identification Imprint: 6010/FW5P+ Tip Color: none

Fleetweld® 5P+ rev. C-EN29-01/02/16

All information in this data sheet is accurate to the best of our knowledge at the time of printing. Please refer to www.lincolnelectric.eu for any updated information.
 Fumes: Safety Data Sheets (SDS) are available on our website.

Fleetweld® 5P+

EXAMPLES OF MATERIALS TO BE WELDED

Steel grades/Code	Type
Pipe material	
EN 10208-1	L 210, L 240
EN 10208-2	L 240, L 290, L 360
EN 10216-1 / 10217-1	P 235, P 275, P 355
API 5LX	X42, X46, X52
Gaz de France	X42, X46, X52

CALCULATION DATA

Sizes Diam. x length (mm)	Current range (A)	Current type	Weight/ 1000 pcs (kg)
2.5x350	40-70	DC+	15.8
3.2x350	65-130	DC+	26.2
4.0x350	90-175	DC+	40.0
5.0x350	140-225	DC+	62.5

*Stub end 35mm

WELDING PARAMETERS, OPTIMUM FILL PASSES

Diameter (mm)	Welding positions	
	PH/5G up	PJ/5G down
2.5	55A	65A
3.2	90A	110A
4.0	130A	150A
5.0	150A	165A

REMARKS / APPLICATION ADVICE

Preheating pipe material L360 (X52) required (acc. EN 1011-1)

Pipeclamps to be removed after finishing root pass, start welding hot pass (within 5 min) after root pass

Use electrodes directly from metal cans

CLASSIFICATION

AWS A5.1	E 6012	A-Nr	1
ISO 2560-A	E 38 0 RC 11	F-Nr	2
		9606 FM	1

GENERAL DESCRIPTION

All position rutile electrode with excellent vertical down welding properties
 Shipbuilding repairs
 Excellent on painted or rustcovered steel
 Recommended for bridging wide gaps
 Weldable in all positions with one current setting

WELDING POSITIONS (ISO/ASME)

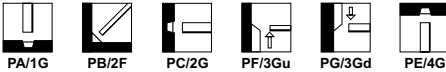

CURRENT TYPE

AC / DC -

APPROVALS

ABS	BV	DNV	GL	LR	RMRS	TÜV
2	2	2	2	2	2	+

CHEMICAL COMPOSITION (W%), TYPICAL, ALL WELD METAL

C	Mn	Si
0.12	0.5	0.6

MECHANICAL PROPERTIES, TYPICAL, ALL WELD METAL

Condition	Yield strength [N/mm ²]	Tensile strength [N/mm ²]	Elongation [%]	Impact ISO-V(J) 0°C
Required: AWS A5.1 ISO 2560-A	min. 330 min. 380	min. 430 470-600	min. 17 min. 20	not required min. 47
Typical values AW	470	550	23	56

PACKAGING AND AVAILABLE SIZES

	Diameter (mm)	2,5	3,2	4,0	5,0
	Length (mm)	350	350	350	350
Carton + PE foil	Pieces / unit	145	180	120	80
	Net weight/unit (kg)	2.8	5.0	5.0	5.2

Identification Imprint: 6012 / SUPRA

Tip Color: none

Supra® rev. C-EN24-01/02/16

All information in this data sheet is accurate to the best of our knowledge at the time of printing. Please refer to www.lincolnelectric.eu for any updated information. Fumes: Safety Data Sheets (SDS) are available on our website.

Supra®

EXAMPLES OF MATERIALS TO BE WELDED

Steel grades/Code	Type
General structural steels	
EN 10025	S185, S235, S275
Ship plates	
ASTM A 131	Grade A, B, D
Fine grained steels	
EN 10025 part 3	S275
EN 10025 part 4	S275

CALCULATION DATA

Sizes Diam. x length [mm]	Current range [A]	Current type	Arc time	Energy	Dep. rate	Weight/ 1000 pcs [kg]	Electrodes/ kg weldmetal B	kg electrodes/ kg weldmetal 1/N
			- per electrode at max. current - [S]*	E[kJ]	H[kg/h]			
2.5x350	70-90	AC	47	109	0.8	175	90	1.58
3.2x350	95-130	AC	64	175	1.1	276	53	1.45
4.0x350	130-170	AC	66	330	1.4	411	39	1.61
5.0x350	170-250	AC	77	534	1.8	63.6	26	1.63

*Stub end 35mm

WELDING PARAMETERS, OPTIMUM FILL PASSES

Diameter [mm]	Welding positions					
	PA/1G	PB/2F	PC/2G	PF/3G up	PG/3G down	PE/4G
2.5	85A	115A	80A	80A	80A	80A
3.2	115A	115A	120A	120A	120A	120A
4.0	155A	170A	155A	160A	180A	155A
5.0	190A	220A			240A	190A

REMARKS / APPLICATION ADVICE

Weldable in all positions with one current setting

CLASSIFICATION

AWS A5.1	E 6013	A-Nr	1
ISO 2560-A	E 42 0 RC 11	F-Nr	2
		9606 FM	1

GENERAL DESCRIPTION

Rutile general purpose, all position electrode, including vertical down
 Applicable for “clean” structural steel
 Smaller diameters excellent for hobby market
 Very suitable for low open circuit voltage transformers

WELDING POSITIONS (ISO/ASME)



CURRENT TYPE

AC / DC -

APPROVALS

ABS	BV	GL	LR	RMRS	DNV
2	2	2	2	2	2

CHEMICAL COMPOSITION (W%), TYPICAL, ALL WELD METAL

C	Mn	Si
0.07	0.5	0.5

MECHANICAL PROPERTIES, TYPICAL, ALL WELD METAL

Condition	Yield strength (N/mm ²)	Tensile strength (N/mm ²)	Elongation (%)	Impact ISO-V(J) 0°C
Required: AWS A5.1 ISO 2560-A Typical values	min. 330 min. 420	min. 430 500-640	min. 17 min. 20	not required min. 47
AW	520	550	26	60

PACKAGING AND AVAILABLE SIZES

	Diameter (mm)	2.5	3.2	4.0
	Length (mm)	350	350	350
Carton + PE foil	Pieces / unit	155	155	120
	Net weight/unit (kg)	2.8	4.8	5.4

Identification Imprint: 6013/OMNIA Tip Color: none

Omnia® rev. C-EN24-01/02/16

EXAMPLES OF MATERIALS TO BE WELDED

Steel grades/Code	Type
General structural steels	
EN 10025	S185, S235, S275
Ship plates	
ASTM A 131	Grade A, B, D
Cast steels	
EN 10213-2	GP240R
Pipe material	
EN 10208-1	L210, L240, L290
EN 10208-2	L240, L290
API 5LX	X42, X46
EN 10216-1/EN10217-1	P235, P275
Boiler & pressure vessel steels	
EN 10028-2	P235, P265, P295
Fine grained steels	
EN 10025 part 3	S275
EN 10025 part 4	S275

CALCULATION DATA

Sizes Diam. x length (mm)	Current range (A)	Current type	Arc time	Energy	Dep. rate	Weight/ 1000 pcs (kg)	Electrodes/ kg weldmetal B	kg electrodes/ kg weldmetal 1/N
			- per electrode at max. current - [S]*	E(kJ)	H(kg/h)			
2.5x350	65-90	AC	52	108	0.8	18.5	85	1.59
3.2x350	95-130	AC	65	229	1.0	31.1	53	1.67
4.0x350	130-160	AC	72	333	1.3	43.6	37	1.61

*Stub end 35mm

WELDING PARAMETERS, OPTIMUM FILL PASSES

Diameter (mm)	Welding positions					
	PA/1G	PB/2F	PC/2G	PF/3G up	PG/3G down	PE/4G
2.5	80A	75A	75A	75A	75A	75A
3.2	120A	115A	125A	115A	125A	115A
4.0	175A	165A	160A	160A	170A	160A

REMARKS / APPLICATION ADVICE

Vertical down only applicable for "clean" structural steel

CLASSIFICATION

AWS A5.1	E 6013	A-Nr	1
ISO 2560-A	E 38 0 RC 11	F-Nr	2
		9606 FM	1

GENERAL DESCRIPTION

Rutile general purpose, all position electrode, including vertical down
Soft arc therefore suitable for relative thin plates and bridging wide gaps
Excellent in pipe welding and construction
Good start and restart behaviour
Also weldable with low Open Circuit Voltage transformers (min. OCV 42V)
Good X-ray soundness

WELDING POSITIONS (ISO/ASME)



PA/1G



PB/2F



PC/2G



PF/3Gu



PG/3Gd



PE/4G



PH/5Gu



PJ/5Gd

CURRENT TYPE

AC / DC -

APPROVALS

TÜV

+

CHEMICAL COMPOSITION (W%), TYPICAL, ALL WELD METAL

C	Mn	Si
0.09	0.5	0.4

MECHANICAL PROPERTIES, TYPICAL, ALL WELD METAL

Condition	Yield strength [N/mm ²]	Tensile strength [N/mm ²]	Elongation [%]	Impact ISO-V[J] 0°C
Required: AWS A5.1 ISO 2560-A	min. 330 min. 380	min. 430 470-600	min. 17 min. 20	not required min. 47
Typical values AW	500	540	24	60

PACKAGING AND AVAILABLE SIZES

	Diameter (mm)	2.0	2.5	3.2	4.0
	Length (mm)	300	350	350	350
Carton + PE foil	Pieces / unit	235	145	155	120
	Net weight/unit (kg)	2.4	2.8	4.8	5.4

Identification Imprint: 6013 / PANTAFIX Tip Color: none

Pantafix® rev. C-EN25-01/02/16

EXAMPLES OF MATERIALS TO BE WELDED

Steel grades/Code	Type
General structural steels	
EN 10025	S185, S235, S275
Ship plates	
ASTM A 131	Grade A, B, D
Cast steels	
EN 10213-2	GP240R
Pipe material	
EN 10208-1	L210, L240, L290
EN 10208-2	L240, L290
API 5LX	X42, X46
EN 10216-1/EN10217-1	P235, P275
Boiler & pressure vessel steels	
EN 10028-2	P235, P265, P295
Fine grained steels	
EN 10025 part 3	S275
EN 10025 part 4	S275

CALCULATION DATA

Sizes Diam. x length (mm)	Current range (A)	Current type	Arc time	Energy	Dep. rate	Weight/ 1000 pcs (kg)	Electrodes/ kg weldmetal/ B	kg electrodes/ kg weldmetal 1/N
			- per electrode at max. current - [S]*	E[kJ]	H[kg/h]			
2.0x300	40-75	AC	41	58	0.5	10.4	178	1.98
2.5x350	50-90	AC	60	130	0.7	17.8	88	1.57
3.2x350	70-130	AC	66	206	1.0	29.5	53	1.58
4.0x350	130-175	AC	72	333	1.3	43.6	37	1.61

*Stub end 35mm

WELDING PARAMETERS, OPTIMUM FILL PASSES

Diameter (mm)	Welding positions					
	PA/1G	PB/2F	PC/2G	PF/3G up	PG/3G down	PE/4G
2.5	80A	75A	75A	75A	75A	75A
3.2	120A	115A	125A	115A	125A	115A
4.0	175A	165A	160A	160A	170A	160A

REMARKS / APPLICATION ADVICE

Vertical down only applicable for "clean" structural steel

Omnia[®] 46

SMAW

CLASSIFICATION

AWS A5.1	E 6013	A-Nr	1
ISO 2560-A	E 38 0 R 11	F-Nr	2
		9606 FM	1

GENERAL DESCRIPTION

Rutile general purpose, all positions electrode
 Applicable for "clean" structural steel (2.0, 2.5, 3.2 mm)
 Smaller diameters excellent for hobby market
 Very suitable for low open circuit voltage transformers (min. OCV 42 V)

WELDING POSITIONS (ISO/ASME)

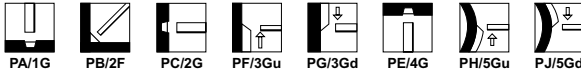

CURRENT TYPE

AC / DC -

APPROVALS

ABS	BV	DNV	GL	LR	TÜV
2	2	2	2	2	+

CHEMICAL COMPOSITION (W%), TYPICAL, ALL WELD METAL

C	Mn	Si
0.06	0.5	0.45

MECHANICAL PROPERTIES, TYPICAL, ALL WELD METAL

Condition	Yield strength (N/mm ²)	Tensile strength (N/mm ²)	Elongation (%)	Impact ISO-V(J) 0°C
Required: AWS A5.1 ISO 2560-A Typical values	min. 330 min. 380	min. 430 470-600	min. 17 min. 20	not required min. 47
AW	460	540	27	65

PACKAGING AND AVAILABLE SIZES

	Diameter (mm)	1.6	2.0	2.5	3.2	3.2	4.0	4.0	5.0
	Length (mm)	250	300	350	350	450	350	450	450
Carton + PE foil	Pieces / unit	130	370	250	175	150	110	95	55
	Net weight/unit (kg)	0.8	4.2	4.8	5.3	6.2	5.0	5.9	5.8
Unit : Linc Pack	Pieces / unit	-	89	54	33	-	22	-	-
	Net weight/unit (kg)	-	1.0	1.0	1.0	-	1.0	-	-

Identification Imprint: 6013-OMNIA 46 Tip Color: yellow

Omnia[®] 46: rev. C-EN27-01/02/16

All information in this data sheet is accurate to the best of our knowledge at the time of printing. Please refer to www.lincolnelectric.eu for any updated information.
 Fumes: Safety Data Sheets (SDS) are available on our website.

Omnia[®] 46

EXAMPLES OF MATERIALS TO BE WELDED

Steel grades/Code	Type
General structural steels	
EN 10025	S185, S235, S275
Ship plates	
ASTM A 131	Grade A, B, D
Cast steels	
EN 10213-2	GP240R
Pipe material	
EN 10208-1	L210, L240, L290
EN 10208-2	L240, L290
API 5LX	X42, X46
EN 10216-1/EN10217-1	P235, P275
Boiler & pressure vessel steels	
EN 10028-2	P235, P265, P295
Fine grained steels	
EN 10025 part 3	S275
EN 10025 part 4	S275

SMAW

CALCULATION DATA

Diam. x length (mm)	Current range (A)	Current type	Arc time	Energy	Dep. rate	Weight/ 1000 pcs (kg)	Electrodes/ kg weldmetal	kg electrodes/ kg weldmetal
			[S]*	E(kJ)	H(kg/h)		B	1/N
2.0x300	50-60	AC	43	57	0.5	11.4	154	1.68
2.5x350	70-90	AC	68	134	0.6	19.2	84	1.60
3.2x350	90-125	AC	80	220	0.9	30.3	50	1.51
3.2x450	100-135	AC	102	303	0.9	41.3	38	1.56
4.0x350	140-190	AC	74	323	1.5	45.5	33	1.49
4.0x450	150-200	AC	95	456	1.5	62.1	26	1.58
5.0x450	180-240	AC	115	662	1.8	105.5	17	1.75

*Stub end 35mm

WELDING PARAMETERS, OPTIMUM FILL PASSES

Diameter (mm)	Welding positions							
	PA/1G	PB/2F	PC/2G	PF/3Gup	PG/3Gdown	PE/4G	PH/5Gup	PJ/5Gdown
2.0	55A	55A	55A	50A	55A		50A	55A
2.5	80A	85A	85A	80A	85A	85A	80A	85A
3.2	110A	115A	115A	110A	115A	110A	110A	115A
4.0	170A	175A	175A	175A	180A	175A	175A	180A
5.0	220A	230A		230A				

Numal

SMAW

CLASSIFICATION

AWS A5.1	E 6013	A-Nr	1
ISO 2560-A	E 38 0 R 11	F-Nr	2
		9606 FM	1

GENERAL DESCRIPTION

Rutile general purpose, all positions electrode
 Applicable for "clean" structural steel
 Smaller diameters excellent for hobby market
 Very suitable for low open circuit voltage transformers (min. OCV 42 V)

WELDING POSITIONS (ISO/ASME)

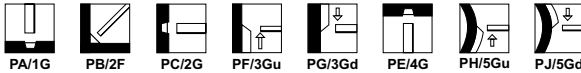

CURRENT TYPE

AC / DC -

APPROVALS

ABS	BV	DNV	GL	LR	TÜV
2	2	2	2	2	+

CHEMICAL COMPOSITION (W%), TYPICAL, ALL WELD METAL

C	Mn	Si
0.06	0.5	0.45

MECHANICAL PROPERTIES, TYPICAL, ALL WELD METAL

Condition	Yield strength [N/mm ²]	Tensile strength [N/mm ²]	Elongation [%]	Impact ISO-V(J) 0°C
Required: AWS A5.1 ISO 2560-A Typical values	min. 331 min. 420 430	min. 414 500-640 480	min. 17 min. 20 26	not required min. 47 60
AW				

PACKAGING AND AVAILABLE SIZES

	Diameter (mm)	2.0	2.5	3.2	3.2	4.0	5.0
	Length (mm)	300	350	350	450	350	450
Carton + PE foil	Pieces / unit	180	275	195	150	110	55
	Net weight/unit (kg)	2.0	5.2	5.67	6.2	5.0	5.8

Identification Imprint: 6013-NUMAL Tip Color: yellow

Numal.rev. C-EN04-01/02/16

All information in this data sheet is accurate to the best of our knowledge at the time of printing. Please refer to www.lincolnelectric.eu for any updated information.
 Fumes: Safety Data Sheets (SDS) are available on our website.

Numal

SMAW

MATERIALS TO BE WELDED

Steel grades/Code	Type
General structural steels	
EN 10025	S185, S235, S275
Ship plates	
ASTM A 131	Grade A, B, D
Cast steels	
EN 10213-2	G P 240R
Pipe material	
EN 10208-1	L210, L240, L290
EN 10208-2	L240, L290
API 5LX	X42, X46
EN 10216-1/EN10217-1	P235, P275
Boiler & pressure vessel steels	
EN 10028-2	P235, P265, P295
Fine grained steels	
EN 10025 part 3	S275
EN 10025 part 4	S275

CALCULATION DATA

Diam. x length (mm)	Current range (A)	Current type	Arc time	Energy	Dep. rate	Weight/ 1000 pcs (kg)	Electrodes/ kg weldmetal B	kg electrodes/ kg weldmetal 1/N
			- per electrode at max. current - (S)*	E(kJ)	H(kg/h)			
2.5x350	70-90	AC	68	134	0.6	19.2	84	1.60
3.2x350	90-125	AC	80	220	0.9	30.3	50	1.51
4.0x350	140-190	AC	74	323	1.5	45.5	33	1.49

*Stub end 35mm

WELDING PARAMETERS, OPTIMUM FILL PASSES

Diameter (mm)	Welding positions							
	PA/1G	PB/2F	PC/2G	PF/3Gup	PG/3Gdown	PE/4G	PH/5Gup	PJ/5Gdown
2.5	80A	85A	85A	80A	85A	85A	80A	85A
3.2	110A	115A	115A	110A	115A	110A	110A	115A
4.0	170A	175A	175A	175A	180A	175A	175A	180A

CLASSIFICATION

AWS A5.1	E 6013	A-Nr	1
ISO 2560-A	E 38 0 R 12	F-Nr	2
		9606 FM	1

GENERAL DESCRIPTION

Rutile, all position electrode (except vertical down)
 Excellent for pipe welding and construction work
 Smooth side wall wetting
 Good X-ray soundness

WELDING POSITIONS (ISO/ASME)

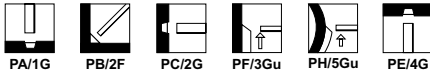

CURRENT TYPE

AC / DC -

APPROVALS

ABS	BV	DNV	GL	LR	TÜV
2	2	2	2	2,2Y	+

CHEMICAL COMPOSITION (W%), TYPICAL, ALL WELD METAL

C	Mn	Si
0.1	0.5	0.4

MECHANICAL PROPERTIES, TYPICAL, ALL WELD METAL

Condition	Yield strength (N/mm ²)	Tensile strength (N/mm ²)	Elongation (%)	Impact ISO-V(J) 0°C
Required: AWS A5.1 ISO 2560-A	min. 330 min. 380	min. 430 470-600	min. 17 min. 20	not required min. 47
Typical values AW	500	540	25	55

PACKAGING AND AVAILABLE SIZES

	Diameter (mm)	2.5	3.2	4.0
	Length (mm)	350	350	350
Carton + PE foil	Pieces / unit	150	175	115
	Net weight/unit (kg)	2.9	5.2	5.3

Identification Imprint: 6013 / CUMULO Tip Color: none

Cumulo: rev. C-EN25-01/02/16

EXAMPLES OF MATERIALS TO BE WELDED

Steel grades/Code	Type
General structural steels	
EN 10025	S185, S235, S275
Ship plates	
ASTM A 131	Grade A, B, D
Cast steels	
EN 10213-2	GP240R
Pipe material	
EN 10208-1	L210, L240, L290
EN 10208-2	L240, L290
API 5LX	X42, X46
EN 10216-1/EN10217-1	P235, P275
Boiler & pressure vessel steels	
EN 10028-2	P235, P265, P295
Fine grained steels	
EN 10025 part 3	S275
EN 10025 part 4	S275

CALCULATION DATA

Sizes		Current type	Arc time - per electrode at max. current - [S]*	Energy E(kJ)	Dep. rate H(kg/h)	Weight/ 1000 pcs [kg]	Electrodes/ kg weldmetal B	kg electrodes/ kg weldmetal 1/N
Diam. x length [mm]	Current range [A]							
2.5x350	65-90	AC	52	120	0.8	18.7	86	1.61
3.2x350	85-130	AC	66	181	1.1	29.7	51	1.53
4.0x350	130-180	AC	62	345	1.6	46.5	36	1.69

*Stub end 35mm

WELDING PARAMETERS, OPTIMUM FILL PASSES

Diameter [mm]	Welding positions					
	PA/1G	PB/2F	PC/2G	PF/3Gup	PE/4G	PH/5Gup
2.5	95A	85A	85A	75A	75A	75A
3.2	135A	135A	120A	120A	120A	120A
4.0	160A	160A	155A	140A	140A	

Universalis®

CLASSIFICATION

AWS A5.1	E 6013	A-Nr	1
ISO 2560-A	E 42 0 RR 12	F-Nr	2
		9606 FM	1

GENERAL DESCRIPTION

Rutile electrode, especially for down hand welding in structural steel
 Smaller sizes (2.0 & 2.5 mm) most versatile for thin plate material
 Very smooth appearance
 Self releasing slag

WELDING POSITIONS (ISO/ASME)



PA/1G



PB/2F



PC/2G



PE/4G

CURRENT TYPE

AC / DC -

APPROVALS

ABS	BV	DNV	GL	LR	TÜV
2Y	2Y	2Y	2Y	2Y	+

CHEMICAL COMPOSITION (W%), TYPICAL, ALL WELD METAL

C	Mn	Si
0.1	0.6	0.4

MECHANICAL PROPERTIES, TYPICAL, ALL WELD METAL

	Condition	Yield strength (N/mm ²)	Tensile strength (N/mm ²)	Elongation (%)	Impact ISO-V(J) 0°C
Required: AWS A5.1 ISO 2560-A		min. 330	min. 430	min. 17	not required
Typical values	AW	480	500-640 560	min. 20 26	min. 47 50

PACKAGING AND AVAILABLE SIZES

	Diameter (mm)	2.0	2.5	3.2	3.2	4.0
	Length (mm)	300	350	350	450	450
Carton + PE foil	Pieces / unit	200	130	140	125	80
	Net weight/unit (kg)	2.4	2.8	4.8	5.8	5.9

Identification Imprint: 6013 / UNIVERSALIS Tip Color: none

Universalis® rev. C-EN25-01/02/16

EXAMPLES OF MATERIALS TO BE WELDED

Steel grades/Code	Type
General structural steels	
EN 10025	S185, S235, S275, S355
Ship plates	
ASTM A 131	Grade A, B, D, AH32 to DH36
Cast steels	
EN 10213-2	GP240R
Pipe material	
EN 10208-1	L210, L240, L290, L360
EN 10208-2	L240, L290, L360
API 5LX	X42, X46, X52, X60
EN 10216-1/EN10217-1	P235, P275, P355
Boiler & pressure vessel steels	
EN 10028-2	P235, P265, P295, P355
Fine grained steels	
EN 10025 part 3	S275, S355
EN 10025 part 4	S275, S355

CALCULATION DATA

Sizes Diam. x length (mm)	Current range (A)	Current type	Arc time	Energy	Dep. rate	Weight/ 1000 pcs (kg)	Electrodes/ kg weldmetal/ B	kg electrodes/ kg weldmetal 1/N
			- per electrode at max. current - [S]*	E(kJ)	H(kg/h)			
2.0x300	40-65	AC	41	58	0.5	11.4	178	2.0
2.5x350	70-100	AC	51	134	0.8	21.1	93	1.96
3.2x350	100-140	AC	57	281	1.3	39.3	47	1.85
3.2x450	100-140	AC	69	341	1.5	49.6	36	1.79
4.0x450	150-200	AC	69	483	2.1	66.9	25	1.67

*Stub end 35mm

WELDING PARAMETERS, OPTIMUM FILL PASSES

Diameter (mm)	Welding positions			
	PA/1G	PB/2F	PC/2G	PE/4G
2.0	50A			
2.5	100A	95A	85A	85A
3.2	130A	120A	115A	105A
4.0	185A	185A	160A	130A

REMARKS / APPLICATION ADVICE

Best choice for welding thin plates.

High yield strength steels such as S355, L360, P355 and X60 preheat according EN 1011-1

Rental

SMAW

CLASSIFICATION

AWS A5.1	E7024	A-Nr	1
ISO 2560-A	E 38 0 RR 7 3	F-Nr	1
		9606 FM	1

GENERAL DESCRIPTION

Rutile electrode for fillet welds and horizontal V- and X-welds

190% recovery

Very high welding speed

Smooth weld appearance

Self releasing slag

A very smooth and stable arc with very little spatter

Very neat finely rippled weld

WELDING POSITIONS (ISO/ASME)



PA/1G



PB/2F



PC/2G

CURRENT TYPE

AC / DC -

CHEMICAL COMPOSITION (W%), TYPICAL, ALL WELD METAL

C	Mn	Si
0.07	0.8	0.5

MECHANICAL PROPERTIES, TYPICAL, ALL WELD METAL

Condition	Yield strength (N/mm ²)	Tensile strength (N/mm ²)	Elongation (%)	Impact ISO-V(J) 0°C
Required: AWS A5.1 ISO 2560-A	min. 399 min. 380	min. 490 470-600	min. 17 min. 20	not required min. 47
Typical values AW	440	510-560	24	70

PACKAGING AND AVAILABLE SIZES

	Diameter (mm)	3.2	4.0	5.0
	Length (mm)	350	350	350
Carton	Pieces / unit	40	24	16
	Net weight/unit (kg)	2.7	2.4	2.6

Identification Imprint: 7024 RENTAL

Tip Color: rental

Rental.rev.C-EN01-01/02/16

All information in this data sheet is accurate to the best of our knowledge at the time of printing. Please refer to www.lincolnelectric.eu for any updated information.
Fumes: Safety Data Sheets (SDS) are available on our website.

Rental

EXAMPLES OF MATERIALS TO BE WELDED

Steel grades/Code	Type
General structural steels	
EN 10025	S185, S235, S275, S355
Ship plates	
ASTM A 131	Grade A, B, D, AH32 to DH36
Boiler & pressure vessel steels	
EN 10028-2	P235, P265, P295, P355
Fine grained steels	
EN 10025 part 3	S275, S355
EN 10025 part 4	S275, S355

SMAW

REMARKS / APPLICATION ADVICE

High yield strength steels such as S355, P355 and DH36 preheat according EN 1011-1

Ferrod[®] 165A

CLASSIFICATION

AWS A5.1	E7024-1	A-Nr	1
ISO 2560-A	E 42 2 RA 7 3	F-Nr	1
		9606 FM	1

GENERAL DESCRIPTION

Rutile-acid coated electrode with brittle slag, for fillet welds and horizontal V- and X-welds
 160% recovery, high welding speed
 Good X-ray soundness
 Even in narrow gaps and rusty materials easy slag release
 Class 3 approved

WELDING POSITIONS (ISO/ASME)



PA/1G



PB/2F



PC/2G

CURRENT TYPE

AC / DC +/-

APPROVALS

ABS	DNV	GL	LR	TÜV
3, 3Y	3	3	3, 3Y	+

CHEMICAL COMPOSITION (W%), TYPICAL, ALL WELD METAL

C	Mn	Si
0.07	0.95	0.3

MECHANICAL PROPERTIES, TYPICAL, ALL WELD METAL

Condition	Yield strength (N/mm ²)	Tensile strength (N/mm ²)	Elongation (%)	Impact ISO-V(J)	
				-10°C	-18°C/-20°C
Required: AWS A5.1 ISO 2560-A	min. 400 min. 420	min. 490 500-640	min. 22 min. 20		min. 27 min. 47
Typical values AW	475	520	26	70	67

PACKAGING AND AVAILABLE SIZES

	Diameter (mm)	3,2	4,0	5,0
	Length (mm)	450	450	450
Carton + PE foil	Pieces / unit	99	60	41
	Net weight/unit (kg)	6.1	5.6	6.0

Identification Imprint: 7024-1 / FERROD 165A Tip Color: none

Ferrod 165A¹: rev. C-EN24-01/02/16

All information in this data sheet is accurate to the best of our knowledge at the time of printing. Please refer to www.lincolnelectric.eu for any updated information.
 Fumes: Safety Data Sheets (SDS) are available on our website.

Ferrod[®] 165A

EXAMPLES OF MATERIALS TO BE WELDED

Steel grades/Code	Type
General structural steels	
EN 10025	S185, S235, S275, S355
Ship plates	
ASTM A 131	Grade A, B, D, AH32 to DH36
Cast steels	
EN 10213-2	GP240R
Boiler & pressure vessel steels	
EN 10028-2	P235, P265, P295, P355
Fine grained steels	
EN 10025 part 3	S275, S355
EN 10025 part 4	S275, S355

CALCULATION DATA

Diam. x length (mm)	Current range (A)	Current type	Arc time	Energy	Dep. rate	Weight/ 1000 pcs (kg)	Electrodes/ kg weldmetal/ B	kg electrodes/ kg weldmetal 1/N
			- per electrode at max. current - [S]*	E[kJ]	H[kg/h]			
3.2x450	125-155	AC	75	326	1.9	62.9	25	1.39
4.0x450	140-235	AC	65	527	3.6	96.5	15	1.39
5.0x450	210-330	AC	68	853	5.3	144.9	10	1.39

*Stub end 35mm

WELDING PARAMETERS, OPTIMUM FILL PASSES

Diameter (mm)	Welding positions		
	PA/1G	PB/2F	PC/2G
3.2	160A	150A	150A
4.0	220A	200A	195A
5.0	310A	290A	

REMARKS / APPLICATION ADVICE

High yield strength steels such as S355, P355 and DH36 preheat according EN 1011-1

Ferrod® 135T

SMAW

CLASSIFICATION

AWS A5.1	E7024	A-Nr	1
ISO 2560-A	E 38 0 RR 5 3	F-Nr	1
		9606 FM	1

GENERAL DESCRIPTION

Rutile electrode for fillet welds and horizontal V- and X-welds
 High welding speed
 Smooth weld appearance
 Self releasing slag
 High recovery (140%)

WELDING POSITIONS (ISO/ASME)



PA/1G



PB/2F



PC/2G

CURRENT TYPE

AC / DC -

APPROVALS

ABS	BV	DNV	GL	LR	RMRS	TÜV
2Y	2Y	2Y	2Y	2Y	2Y	+

CHEMICAL COMPOSITION (W%), TYPICAL, ALL WELD METAL

C	Mn	Si
0.08	0.5	0.35

MECHANICAL PROPERTIES, TYPICAL, ALL WELD METAL

Condition	Yield strength (N/mm ²)	Tensile strength (N/mm ²)	Elongation (%)	Impact [ISO-V(J)] 0°C
Required: AWS A5.1 ISO 2560-A Typical values	min. 400 min. 380 460	min. 490 470-600 530	min. 17 min. 20 25	not required 47 54
AW				

PACKAGING AND AVAILABLE SIZES

	Diameter (mm)	3.2	4.0	5.0
	Length (mm)	450	450	450
Carton + PE foil	Pieces / unit	90	65	45
	Net weight/unit (kg)	5.5	5.7	5.9

Identification Imprint: 7024-FERROD 135T

Tip Color: none

Ferrod® 135T; rev. C-EN26-01/02/16

All information in this data sheet is accurate to the best of our knowledge at the time of printing. Please refer to www.lincolnelectric.eu for any updated information.
 Fumes: Safety Data Sheets (SDS) are available on our website.

Ferrod[®] 135T

EXAMPLES OF MATERIALS TO BE WELDED

Steel grades/Code	Type
General structural steels	
EN 10025	S185, S235, S275, S355
Ship plates	
ASTM A 131	Grade A, B, D, AH32 to DH36
Cast steels	
EN 10013-2	GP240R
Boiler & pressure vessel steels	
EN 10028-2	P235, P265, P295, P355
Fine grained steels	
EN 10025 part 3	S275, S355
EN 10025 part 4	S275, S355

CALCULATION DATA

Sizes Diam. x length (mm)	Current range (A)	Current type	Arc time	Energy	Dep. rate	Weight/ 1000 pcs (kg)	Electrodes/ kg weldmetal B	kg electrodes/ kg weldmetal 1/N
			- per electrode at max. current - (S)*	E(kJ)	H(kg/h)			
3.2x450	130-150	AC	85	344	1.6	61.3	27	1.67
4.0x450	180-200	AC	92	515	2.2	87.7	18	1.67
5.0x450	275-300	AC	86	735	3.7	129.9	11	1.43

*Stub end 35mm

WELDING PARAMETERS, OPTIMUM FILL PASSES

Diameter (mm)	Welding positions		
	PA/1G	PB/2F	PC/2G
3.2	150A	140A	140A
4.0	200A	190A	190A
5.0	290A	280A	

REMARKS / APPLICATION ADVICE

High yield strength steels such as S355, P355 and DH36 preheat according EN 1011-1

Ferrod® 160T

CLASSIFICATION

AWS A5.1	E7024	A-Nr	1
ISO 2560-A	E 42 0 RR 7 3	F-Nr	1
		9606 FM	1

GENERAL DESCRIPTION

Rutile electrode for fillet welds and horizontal V- and X-welds
 Very high welding speed
 Smooth weld appearance, very good slag release
 High recovery (160% for 3.2 and 4.0 mm electrodes, and 180% for 5.0 mm electrodes)

WELDING POSITIONS (ISO/ASME)



PA/1G



PB/2F



PC/2G

CURRENT TYPE

AC / DC -

APPROVALS

ABS	BV	DNV	GL	LR	RMRS	TÜV
2Y	2Y	2Y	2Y	2Y	2Y	+

CHEMICAL COMPOSITION (W%), TYPICAL, ALL WELD METAL

C	Mn	Si
0.07	0.9	0.6

MECHANICAL PROPERTIES, TYPICAL, ALL WELD METAL

	Condition	Yield strength (N/mm ²)	Tensile strength (N/mm ²)	Elongation (%)	Impact ISO-V(J) 0°C
Required: AWS A5.1 ISO 2560-A Typical values	AW	min. 400 min. 420 450	min. 490 500-640 570	min. 17 min. 20 26	not required min. 47 70

PACKAGING AND AVAILABLE SIZES

	Diameter (mm)	3.2	4.0	5.0
	Length (mm)	450	450	450
Carton + PE foil	Pieces / unit	85	60	40
	Net weight/unit (kg)	5.6	6.3	6.1

Identification Imprint: 7024/FERROD 160T Tip Color: none

Ferrod® 160T: rev. C-ENZ-01/02/16

Ferrod[®] 160T

EXAMPLES OF MATERIALS TO BE WELDED

Steel grades/Code	Type
General structural steels	
EN 10025	S185, S235, S275, S355
Ship plates	
ASTM A 131	Grade A, B, D, AH32 to DH36
Cast steels	
EN 10013-2	GP240R
Boiler & pressure vessel steels	
EN 10028-2	P235, P265, P295, P355
Fine grained steels	
EN 10025 part 3	S275, S355
EN 10025 part 4	S275, S355

CALCULATION DATA

Sizes Diam. x length (mm)	Current range (A)	Current type	Arc time	Energy	Dep. rate	Weight/ 1000 pcs (kg)	Electrodes/ kg weldmetal B	kg electrodes/ kg weldmetal 1/N
			- per electrode at max. current - (S)*	E(kJ)	H(kg/h)			
3.2x450	130-160	AC						
4.0x350	180-220	AC	90	554	2.6	92.7	15	1.43
5.0x450	280-300	AC	78	897	5.4	166.7	9	1.43

*Stub end 35mm

WELDING PARAMETERS, OPTIMUM FILL PASSES

Diameter (mm)	Welding positions	
	PA/1G	PB/2F
3.2	150A	140A
4.0	210A	200A
5.0	300A	280A

REMARKS / APPLICATION ADVICE

High yield strength steels such as S355, P355 and DH36 preheat according EN 1011-1

Gonia 180

SMAW

CLASSIFICATION

AWS A5.1	E7024	A-Nr	1
ISO 2560-A	E 42 0 RR 7 3	F-Nr	1
		9606 FM	1

GENERAL DESCRIPTION

Rutile electrode for fillet welds and horizontal V- and X-welds
 190% recovery
 Very high welding speed
 Smooth weld appearance
 Self releasing slag

WELDING POSITIONS (ISO/ASME)



PA/1G



PB/2F



PC/2G

CURRENT TYPE

AC / DC -

APPROVALS

ABS	BV	CRS	DNV	GL	LR	RINA	RMRS
2	2Y	2Y	2	2Y	2	2	2

CHEMICAL COMPOSITION (W%), TYPICAL, ALL WELD METAL

C	Mn	Si
0.07	1.0	0.35

MECHANICAL PROPERTIES, TYPICAL, ALL WELD METAL

Condition	Yield strength (N/mm ²)	Tensile strength (N/mm ²)	Elongation (%)	Impact ISO-V(J) 0°C
Required: AWS A5.1 ISO 2560-A Typical values	min. 399 min. 420 450	min. 490 500-640 525	min. 17 min. 20 27	not required min. 47 75
AW				

PACKAGING AND AVAILABLE SIZES

	Diameter (mm)	4.0	5.0	6.3
	Length (mm)	450	450	450
Carton + PE foil	Pieces / unit	55	35	23
	Net weight/unit (kg)	5.8	5.8	5.7

Identification Imprint: 7024/ GONIA 180

Tip Color: blue

Gonia 180: rev. C-EN24-01/02/16

All information in this data sheet is accurate to the best of our knowledge at the time of printing. Please refer to www.lincolnelectric.eu for any updated information.
 Fumes: Safety Data Sheets (SDS) are available on our website.

Gonia 180

EXAMPLES OF MATERIALS TO BE WELDED

Steel grades/Code	Type
General structural steels	
EN 10025	S185, S235, S275, S355
Ship plates	
ASTM A 131	Grade A, B, D, AH32 to DH36
Boiler & pressure vessel steels	
EN 10028-2	P235, P265, P295, P355
Fine grained steels	
EN 10025 part 3	S275, S355
EN 10025 part 4	S275, S355

CALCULATION DATA

Sizes		Current type	Arc time - per electrode at max. current - (S)*	Energy E(kJ)	Dep. rate H(kg/h)	Weight/ 1000 pcs (kg)	Electrodes/ kg weldmetal B	kg electrodes/ kg weldmetal 1/N
Diam. x length (mm)	Current range (A)							
4.0x450	200-240	AC	78	515	3.4	100.0	14	1.35
5.0x450	280-300	AC	85	816	4.9	157.7	9	1.35
6.3x450	350-375	AC	102	1320	6.5	248.0	6	1.35

*Stub end 35mm

WELDING PARAMETERS, OPTIMUM FILL PASSES

Diameter (mm)	Welding positions		
	PA/1G	PB/2F	PC/2G
4.0	210A	200A	200A
5.0	300A	280A	
6.3	390A	360A	

REMARKS / APPLICATION ADVICE

High yield strength steels such as S355, P355 and DH36 preheat according EN 1011-1

Baso[®] 48SP

CLASSIFICATION

AWS A5.1	E 7018-1 H8	A-Nr	1
ISO 2560-A	E 46 3 B 3 2 H10*	F-Nr	4
* also complies to E 46 3 BR 3 2 H10		9606 FM	1

GENERAL DESCRIPTION

Rutile basic coated electrode with excellent start- and restart properties
 Weldable on AC and DC
 Stable arc, also at low amperage
 Popular at welding schools
 Min. 60 Volt is recommended
 Good mechanical and impact properties down to -30°C (>47 J)
 Low hydrogen content (HDM < 8 ml/100g)

WELDING POSITIONS (ISO/ASME)



PA/1G



PB/2F



PC/2G



PF/3Gu



PE/4G

CURRENT TYPE

∅ 2.5 AC / DC + / -
 ∅ 3.2 AC / DC +
 ∅ 4.0 AC / DC +
 ∅ 5.0 AC / DC

APPROVALS

ABS	BV	DNV	LR	TÜV
3YH10	HHH	3YH5	3,3YH10	+

CHEMICAL COMPOSITION (W%), TYPICAL, ALL WELD METAL

C	Mn	Si	HDM
0.075	1.4	0.45	7 ml/100 g

MECHANICAL PROPERTIES, TYPICAL, ALL WELD METAL

	Condition	Yield strength (N/mm ²)	Tensile strength (N/mm ²)	Elongation (%)	Impact ISO-V(J)		
					-20°C	-30°C	-46°C
Required: AWS A5.1 ISO 2560-A		min. 400 min. 460	min. 490 530-680	min. 22 min. 20			min. 27
Typical values	AW	590	640	25	90	min. 47 60	

PACKAGING AND AVAILABLE SIZES

	Diameter (mm)	Length (mm)	Carton + PE foil			SRP	
			Pieces / unit	Net weight/unit (kg)	Pieces / unit	Net weight/unit (kg)	
	2.5	350	125	2.5	44	0.9	
	3.2	350	78	2.6	51	1.8	
	3.2	450	78	3.3	-	-	
	4.0	350	50	2.5	27	1.4	
	4.0	450	50	3.4	-	-	

Identification Imprint: 7018-1-BASO 48SP Tip Color: green

Baso[®] 48SP+ rev. C-EN25-12/05/16

Baso[®] 48SP

EXAMPLES OF MATERIALS TO BE WELDED

Steel grades/Code	Type
General structural steels	
EN 10025	S185, S235, S275, S355
Ship plates	
ASTM A 131	Grade A, B, D, AH32 to EH36
Cast steels	
EN 10213-2	GP240R
Pipe material	
EN 10208-1	L210, L240, L290, L360
EN 10208-2	L240, L290, L360, L415
API 5LX	X42, X46, X52, X60
EN 10216-1	P235T1, P235T2, P275T1
EN 10217-1	P275T2, P355N
Boiler & pressure vessel steels	
EN 10028-2	P235GH, P265GH, P295GH, P355GH
Fine grained steels	
EN 10025 part 3	S275, S355, S420
EN 10025 part 4	S275, S355, S420, S460

CALCULATION DATA

Sizes Diam. x length (mm)	Current range (A)	Current type	Arc time	Energy	Dep. rate	Weight/ 1000 pcs (kg)	Electrodes/ kg weldmetal B	kg electrodes/ kg weldmetal 1/N
			- per electrode at max. current - [S]*	E[kJ]	H[kg/h]			
2.5x350	50-85	AC	48	104	0.9	19.4	82	1.6
3.2x450	85-135	AC	75	273	1.1	41.0	42	1.72
4.0x450	135-190	AC	95	487	1.6	64.6	24	1.55

*Stub end 35mm

WELDING PARAMETERS, OPTIMUM FILL PASSES

Diameter (mm)	Welding positions				
	PA/1G	PB/2F	PC/2G	PF/3Gup	PE/4G
2.5	80A	85A	85A	85A	80A
3.2	120A	115A	115A	115A	110A
4.0	170A	180A	180A	180A	160A

REMARKS / APPLICATION ADVICE

Redry electrodes 2-4h 350 ±25°C after removal from cardboard boxes

Basic 7018

CLASSIFICATION

AWS A5.1	E7018 H4	A-Nr	1
ISO 2560-A	E 42 4 B 4 2 H5	F-Nr	4
		9606 FM	1

GENERAL DESCRIPTION

Electrode producing crack-free welded joints with good toughness properties even on steels with a carbon content up to 0,4 %.
Recovery 120%

Excellent weldability even in positional welding

Good impact values down to -40°C

Suitable for depositing buffer layers on steels having a higher carbon content

WELDING POSITIONS (ISO/ASME)



PA/1G



PB/2F



PC/2G



PF/3Gu



PE/4G

CURRENT TYPE

DC +

APPROVALS

BV	DNV	LR	DB	GL	TÜV
3YH5	3YH5	3YH10	+	3YH5	+

CHEMICAL COMPOSITION (W%), TYPICAL, ALL WELD METAL

C	Mn	Si	HDM
0.05	1.3	0.4	4 ml/100 g

MECHANICAL PROPERTIES, TYPICAL, ALL WELD METAL

	Condition	Yield strength (N/mm ²)	Tensile strength (N/mm ²)	Elongation (%)	Impact ISO-V(J)	
					-40°C	-46°C
Required: AWS A5.1		min. 400	min. 490	min. 22		min. 27
ISO 2560-A		min. 420	500-640	min. 20	min. 47	
Typical values	AW	475	540	27	105	50

PACKAGING AND AVAILABLE SIZES

	Diameter (mm)	2.5	3.2	3.2	4.0	4.0	5.0
	Length (mm)	350	350	450	350	450	450
Carton + PE foil	Pieces / unit	205	125	125	85	85	55
	Net weight/unit (kg)	4.6	4.5	5.9	4.6	6.0	5.8

Identification Imprint: 7018 / BASIC 7018

Tip Color: none

Basic 7018: rev. C-EN02-01/02/16

All information in this data sheet is accurate to the best of our knowledge at the time of printing. Please refer to www.lincolnelectric.eu for any updated information.
Fumes: Safety Data Sheets (SDS) are available on our website.

Basic 7018

EXAMPLES OF MATERIALS TO BE WELDED

Steel grades/Code	Type
General structural steels	
EN 10025	S185, S235, S275, S355
Ship plates	
ASTM A 131	Grade A, B, D, AH32 to EH36
Cast steels	
EN 10213-2	GP240R
Pipe material	
EN 10208-1	L210, L240, L290, L360
EN 10208-2	L240, L290, L360, L415, L445
API 5LX	X42, X46, X52, X60
EN 10216-1	P235T1, P235T2, P275T1
EN 10217-1	P275T2, P355N
Boiler & pressure vessel steels	
EN 10028-2	P235GH, P265GH, P295GH, P355GH
Fine grained steels	
EN 10025 part 3	S275, S355, S420
EN 10025 part 4	S275, S355, S420

SMAW

REMARKS / APPLICATION ADVICE

Redry electrodes 2-4h 350 ±25°C after removal from cardboard boxes

Baso[®] 51P

CLASSIFICATION

AWS A5.1	E7018-1	A-Nr	1
ISO 2560-A	E 46 3 B 3 2 H5	F-Nr	4
		9606 FM	1

GENERAL DESCRIPTION

Basic low hydrogen electrode
 Excellent for tube welding and root passes
 Very good weldability, in all positions
 Stable arc, also at low amperage
 Easy puddle control and wetting
 Good slag release and flat bead appearance
 Good mechanical and impact properties down to -30°C
 Excellent X-ray soundness

WELDING POSITIONS (ISO/ASME)



PA/1G



PB/2F



PC/2G



PF/3Gu



PH/5Gu



PE/4G

CURRENT TYPE

AC / DC +/-

CHEMICAL COMPOSITION (W%), TYPICAL, ALL WELD METAL

C	Mn	Si	P	S	HDM
0.06	1.3	0.5	0.015	0.010	5 ml/100g

MECHANICAL PROPERTIES, TYPICAL, ALL WELD METAL

Condition	Yield strength (N/mm ²)	Tensile strength (N/mm ²)	Elongation (%)	Impact ISO-V(J)		
				-20°C	-30°C	-46°C
Required: AWS A5.1 ISO 2560-A	min. 400 min. 460	min. 490 530-680	min. 22 min. 20		min. 47	min. 27
Typical values	AW 510	600	27	90	70	40

PACKAGING AND AVAILABLE SIZES

	Diameter (mm)	5,0
	Length (mm)	450
Carton + PE foil	Pieces / unit	55
	Net weight/unit (kg)	5,5

Identification Imprint: 7018-1V BASO 51P

Tip Color: none

Baso[®] 51P; rev. C-EN26-01/02/16

Baso[®] 51P

EXAMPLES OF MATERIALS TO BE WELDED

Steel grades/Code	Type
General structural steels	
EN 10025	S185, S235, S275, S355
Ship plates	
ASTM A 131	Grade A, B, D, AH32 to EH40
Cast steels	
EN 10213-2	GP240R
Pipe material	
EN 10208-1	L210, L240, L290, L360
EN 10208-2	L240, L290, L360, L415
API 5LX	X42, X46, X52, X60
EN 10216-1	P235T1, P235T2, P275T1
EN 10217-1	P275T2, P355N
Boiler & pressure vessel steels	
EN 10028-2	P235GH, P265GH, P295GH, P355GH
Fine grained steels	
EN 10025 part 3	S275, S355, S420
EN 10025 part 4	S275, S355, S420, S460

CALCULATION DATA

Sizes		Current type	Arc time - per electrode at max. current - (s)*	Energy E(kJ)	Dep. rate H(kg/h)	Weight/ 1000 pcs (kg)	Electrodes/ kg weldmetal B	kg electrodes/ kg weldmetal 1/N
Diam. x length (mm)	Current range (A)							
2.5x350	50-100	DC+	48	104	0.9	19.4	82	1.6
3.2x450	75-140	DC+	75	273	1.1	41.0	42	1.72
4.0x450	140-190	DC+	95	487	1.6	64.6	24	1.55
5.0x450	180-280	DC+						

*Stub end 35mm

WELDING PARAMETERS, OPTIMUM FILL PASSES

Diameter (mm)	Welding positions					
	PA/1G	PB/2F	PC/2G	PF/3Gup	PE/4G	PH/5Gup
2.5	90A	90A	80A	85A	80A	85A
3.2	130A	130A	130A	115A	110A	115A
4.0	180A	175A	170A	160A		
5.0	230A	240A	230A			

REMARKS / APPLICATION ADVICE

Redry electrodes 2-4h 350 ±25°C after removal from cardboard boxes

LINCOLN 7016 DR

CLASSIFICATION

AWS A5.1	E7016	A-Nr	1
ISO 2560-A	E 42 2 B 12 H10	F-Nr	4
		9606 FM	1

GENERAL DESCRIPTION

Double Coated Basic Electrode
 Stable arc and smooth welds
 Ideal for pipe welding in both root pass and filling
 Excellent gap bridging
 Good X-ray soundness and start/restart behaviour

WELDING POSITIONS (ISO/ASME)



PA/1G



PB/2F



PC/2G



PF/3Gu



PE/4G

CURRENT TYPE

AC/DC +

APPROVALS

TÜV

Pending

CHEMICAL COMPOSITION (W%), TYPICAL, ALL WELD METAL

C	Mn	Si	HDM
0.08	1.2	0.6	5 ml/100 g

MECHANICAL PROPERTIES, TYPICAL, ALL WELD METAL

	Condition	Yield strength [N/mm ²]	Tensile strength [N/mm ²]	Elongation [%]	Impact ISO-V(J)	
					-20°C	-30°C
Required: AWS A5.1		min. 400	min. 490	min. 22		27
ISO 2560-A		min. 420	500-640	min. 20	47	
Typical values	AW	455	560	28	70	45

PACKAGING AND AVAILABLE SIZES

Carton + PE foil	Diameter (mm)	2.5	3.2	3.2	4.0
	Length (mm)	350	350	450	450
Pieces / unit	Net weight/unit (kg)	205	137	134	81
		4.1	4.3	5.5	5.2

Identification Imprint: Tip Color: none

LINCOLN 7016 DR: rev. C-EN01-01/02/16

LINCOLN 7016 DR

EXAMPLES OF MATERIALS TO BE WELDED

Steel grades/Code	Type
General structural steels	
EN 10025	S185, S235, S275, S355
Ship plates	
ASTM A 131	Grade A, B, D, AH32 to EH36
Cast steels	
EN 10213-2	GP240R
Pipe material	
EN 10208-1	L210, L240, L290, L360
EN 10208-2	L240, L290, L360, L415, L445
API 5LX	X42, X46, X52, X60
EN 10216-1	P235T1, P235T2, P275T1
EN 10217-1	P275T2, P355N
Boiler & pressure vessel steels	
EN 10028-2	P235GH, P265GH, P295GH, P355GH
Fine grained steels	
EN 10025 part 3/4	S275, S355, S420

CALCULATION DATA

Diam. x length (mm)	Current range (A)	Current type	Arc time	Energy	Dep. rate	Weight/ 1000 pcs (kg)	Electrodes/ kg weldmetal B	kg electrodes/ kg weldmetal 1/N
			- per electrode at max. current - (S)*	E(kJ)	H(kg/h)			
2.5x350	60-90							
3.2x350	95-150							
3.2x450	95-150							
4.0x350	140-190							

*Stub end 35mm

REMARKS / APPLICATION ADVICE

Redry electrodes 2-4h 350 ±25°C after removal from cardboard boxes

Baso[®] 100

EMR
SAHARA[®]

SMAW

CLASSIFICATION

AWS A5.1	E7016 H4R	A-Nr	1
ISO 2560-A	E 42 3 B 1 2 H5	F-Nr	4
		9606 FM	1

GENERAL DESCRIPTION

Basic very low hydrogen electrode (HDM< 5 ml/100g)
 Excellent for general purpose welding
 Will run on low open circuit voltage (min. OCV 55 V)
 Good side wall wetting
 Impact toughness down to -30°C
 Popular at welding schools

WELDING POSITIONS (ISO/ASME)



CURRENT TYPE

AC / DC +/-

APPROVALS

ABS	BV	DNV	LR	GL	TÜV
3H,3Y	3,3YHH	3YH5	3,3YH5	3,3YH5	+

CHEMICAL COMPOSITION (W%), TYPICAL, ALL WELD METAL

C	Mn	Si	HDM
0.08	1.0	0.5	4 ml/100 g

MECHANICAL PROPERTIES, TYPICAL, ALL WELD METAL

Condition	Yield strength (N/mm ²)	Tensile strength (N/mm ²)	Elongation (%)	Impact ISO-V(J)	
				-20°C	-29°/-30°C
Required: AWS A5.1 ISO 2560-A Typical values	min. 400 min. 420	min. 490 500-640	min. 22 min. 20		min. 27 min. 47
AW	555	600	26	120	80

PACKAGING AND AVAILABLE SIZES

	Diameter (mm)	2.5	3.2	4.0	5.0
	Length (mm)	350	350	350	450
Carton + PE foil	Pieces / unit	136	120	90	65
	Net weight/unit (kg)	2.5	4.3	4.8	6.3

Identification Imprint: 7016 / BASO 100 Tip Color: Light blue

Baso[®] 100: rev. C-EN26-01/02/16

All information in this data sheet is accurate to the best of our knowledge at the time of printing. Please refer to www.lincolnelectric.eu for any updated information.
 Fumes: Safety Data Sheets (SDS) are available on our website.

Baso[®] 100

EXAMPLES OF MATERIALS TO BE WELDED

Steel grades/Code	Type
General structural steels	
EN 10025	S185, S235, S275, S355
Ship plates	
ASTM A 131	Grade A, B, D, AH32 to EH36
Cast steels	
EN 10213-2	GP240R
Pipe material	
EN 10208-1	L210, L240, L290, L360
EN 10208-2	L240, L290, L360, L415, L445
API 5LX	X42, X46, X52, X60
EN 10216-1	P235T1, P235T2, P275T1
EN 10217-1	P275T2, P355N
Boiler & pressure vessel steels	
EN 10028-2	P235GH, P265GH, P295GH, P355GH
Fine grained steels	
EN 10025 part 3	S275, S355, S420
EN 10025 part 4	S275, S355, S420, S460

CALCULATION DATA

Sizes Diam. x length (mm)	Current range (A)	Current type	Arc time	Energy	Dep. rate	Weight/ 1000 pcs (kg)	Electrodes/ kg weldmetal B	kg electrodes/ kg weldmetal 1/N
			- per electrode at max. current - (S)*	E(kJ)	H(kg/h)			
2.5x350	55-80	AC	53	116	0.8	19.1	85	1.63
3.2x350	75-115	AC	62	229	1.2	36.1	50	1.81
4.0x350	120-160	AC	64	337	1.6	50.1	34	1.72
5.0x450	160-240	AC	91	578	2.4	96.7	16	1.58
5.0x450	160-240	DC+	93	591	2.6	96.7	15	1.44

*Stub end 35mm

WELDING PARAMETERS, OPTIMUM FILL PASSES

Diameter (mm)	Welding positions					
	PA/1G	PB/2F	PC/2G	PF/3Gup	PE/4G	PH/5Gup
2.5	80A	80A	80A	90A	85A	85A
3.2	130A	125A	140A	120A	115A	120A
4.0	165A	160A	165A	150A	140A	
5.0	230A	220A	210A	200A		

REMARKS / APPLICATION ADVICE

Redry electrodes 2-4h 350 ±25°C after removal from cardboard boxes

CLASSIFICATION

AWS A5.1	E7018 H4R	A-Nr	1
ISO 2560-A	E 42 3 B 3 2 H5	F-Nr	4
		9606 FM	1

GENERAL DESCRIPTION

Basic very low hydrogen electrode (HDM<4ml/100g)

Recovery 120%

Excellent weldability even on AC in all positions

Good impact values down to -30°C

Excellent X-ray soundness

WELDING POSITIONS (ISO/ASME)



PA/1G



PB/2F



PC/2G



PF/3Gu



PH/5Gu



PE/4G

CURRENT TYPE

AC / DC +/-

APPROVALS

ABS	BV	DNV	LR	GL	TÜV
3H,3Y	3,3YH	3YH5	3,3YH5	3YH	+

CHEMICAL COMPOSITION (W%), TYPICAL, ALL WELD METAL

C	Mn	Si	HDM
0.08	1.2	0.5	4 ml/100 g

MECHANICAL PROPERTIES, TYPICAL, ALL WELD METAL

	Condition	Yield strength (N/mm ²)	Tensile strength (N/mm ²)	Elongation (%)	Impact ISO-V(J)	
					-20°C	-29°/-30°C
Required: AWS A5.1		min. 400	min. 490	min. 22		min. 27
ISO 2560-A		min. 420	500-640	min. 20		min. 47
Typical values	AW	540	600	26	150	80

PACKAGING AND AVAILABLE SIZES

	Diameter (mm)	2,5	3,2	3,2	4,0	4,0	5,0
	Length (mm)	350	350	450	350	450	450
Carton + PE foil	Pieces / unit	135	120	120	85	85	55
	Net weight/unit (kg)	2.5	4.5	6.0	4.6	5.9	6.0

Identification Imprint: 7018 / BASO 120

Tip Color: silver

Baso[®] 120: rev. C-EN26-01/02/16

All information in this data sheet is accurate to the best of our knowledge at the time of printing. Please refer to www.lincolnelectric.eu for any updated information.
Fumes: Safety Data Sheets (SDS) are available on our website.

Baso[®] 120

SMAW

EXAMPLES OF MATERIALS TO BE WELDED

Steel grades/Code	Type
General structural steels	
EN 10025	S185, S235, S275, S355
Ship plates	
ASTM A 131	Grade A, B, D, AH32 to EH36
Cast steels	
EN 10213-2	GP240R
Pipe material	
EN 10208-1	L210, L240, L290, L360
EN 10208-2	L240, L290, L360, L415, L445
API 5LX	X42, X46, X52, X60
EN 10216-1	P235T1, P235T2, P275T1
EN 10217-1	P275T2, P355N
Boiler & pressure vessel steels	
EN 10028-2	P235GH, P265GH, P295GH, P355GH
Fine grained steels	
EN 10025 part 3	S275, S355, S420
EN 10025 part 4	S275, S355, S420

CALCULATION DATA

Sizes Diam. x length (mm)	Current range (A)	Current type	Arc time	Energy	Dep. rate	Weight/ 1000 pcs (kg)	Electrodes/ kg weldmetal/ B	kg electrodes/ kg weldmetal 1/N
			- per electrode at max. current - [S]*	E[kJ]	H[kg/h]			
2.5x350	60-80	AC	55	121	0.8	19.1	85	1.61
3.2x350	90-140	AC	62	229	1.3	37.1	44	1.64
3.2x450	90-140	AC	74	275	1.5	50.1	33	1.67
4.0x350	120-160	AC	63	338	1.8	54.4	32	1.72
4.0x450	120-160	DC+	85	391	1.9	69.5	22	1.52
5.0x450	160-240	AC	99	616	2.6	108.8	14	1.54
5.0x450	160-240	DC+	100	625	2.6	108.8	14	1.52

*Stub end 35mm

WELDING PARAMETERS, OPTIMUM FILL PASSES

Diameter (mm)	Welding positions				
	PA/1G	PB/2F	PC/2G	PF/3Gup	PE/4G
2.5	80A	80A	85A	85A	80A
3.2	145A	120A	140A	120A	125A
4.0	175A	155A	170A	165A	145A
5.0	235A	220A	210A	195A	

REMARKS / APPLICATION ADVICE

Dry electrodes 2-4h 350 ±25°C after removal from cardboard boxes

CLASSIFICATION

AWS A5.1	E7018-1 H4R	A-Nr	1
ISO 2560-A	E 42 5 B 32 H5	F-Nr	4
		9606 FM	1

GENERAL DESCRIPTION

Basic all position extremely low hydrogen electrode
 115 - 120% recovery
 AC/DC welding in all positions especially pipe
 Excellent for site welding applications
 Good pipe welding
 Good impact values down to -50°C
 Also available in vacuum sealed Sahara ReadyPack® (SRP)

WELDING POSITIONS (ISO/ASME)



PA/1G



PB/2F



PC/2G



PF/3Gu



PE/4G

CURRENT TYPE

AC / DC +/-

APPROVALS

ABS	DB	DNV	LR	GL	RINA	RMRS	TÜV
3H,3Y	3,3YH	3YH5	3,3YH5	3YH10	4YH5	3-3YH5	+

CHEMICAL COMPOSITION (W%), TYPICAL, ALL WELD METAL

C	Mn	Si	HDM
0.05	1.3	0.4	2 ml/100 g

MECHANICAL PROPERTIES, TYPICAL, ALL WELD METAL

Condition	Yield strength [N/mm ²]	Tensile strength [N/mm ²]	Elongation [%]	Impact ISO-V(J)		
				-20°C	-46°C	-50°C
Required: AWS A5.1 ISO 2560-A	min. 400 min. 420	min. 490 500-640	min. 22 min. 20		min. 27	
Typical values	AW 490	575	28	200	130	min. 47 100

PACKAGING AND AVAILABLE SIZES

	Diameter (mm) Length (mm)	2.5		3.2		4.0		5.0	
		350	350	450	350	450	450		
Carton + PE foil	Pieces / unit	135	120	120	85	85	55		
	Net weight/unit (kg)	2.8	4.4	5.8	4.7	5.9	6.0		
SRP	Pieces / unit	69	50	50	28	28	23		
	Net weight/unit (kg)	1.4	2.0	2.5	1.6	2.0	2.6		

Identification Imprint: 7018-1V BASO G+ Tip Color: blue

Baso® G.rev. C-EN27-01/02/16

Baso[®] G

EXAMPLES OF MATERIALS TO BE WELDED

Steel grades/Code	Type
General structural steels	
EN 10025	S185, S235, S275, S355
Ship plates	
ASTM A 131	Grade A, B, D, AH32 to EH40
Cast steels	
EN 10213-2	GP240R
Pipe material	
EN 10208-1	L210, L240, L290, L360
EN 10208-2	L240, L290, L360, L415, L445
API 5LX	X42, X46, X52, X60
EN 10216-1	P235T1, P235T2, P275T1
EN 10217-1	P275T2, P355N
Boiler & pressure vessel steels	
EN 10028-2	P235GH, P265GH, P295GH, P355GH
Fine grained steels	
EN 10025 part 3	S275, S355, S420
EN 10025 part 4	S275, S355, S420

CALCULATION DATA

Sizes Diam. x length (mm)	Current range (A)	Current type	Arc time	Energy	Dep. rate	Weight/ 1000 pcs (kg)	Electrodes/ kg weldmetal B	kg electrodes/ kg weldmetal 1/N
			- per electrode at max. current - [S]*	E[kJ]	H[kg/h]			
2.0x300	35-55	DC+	50	61	0.5	11.7	149	1.75
2.5x350	55-90	DC+	59	107	0.8	20.3	78	1.59
3.2x350	75-120	DC+	70	234	1.2	36.5	42	1.54
3.2x450	75-120	DC+	79	265	1.4	45.4	33	1.47
4.0x350	120-180	DC+	75	358	1.7	50.9	28	1.45
4.0x450	120-180	DC+	96	473	1.7	69.3	22	1.52
5.0x450	160-240	DC+	114	671	2.2	106.2	14	1.54

*Stub end 35mm

WELDING PARAMETERS, OPTIMUM FILL PASSES

Diameter (mm)	Welding positions					
	PA/1G	PB/2F	PC/2G	PF/3Gup	PE/4G	PF/5Gup
2.0						45A
2.5	80A	80A	85A	90A	80A	80A
3.2	145A	120A	150A	120A	115A	120A
4.0	160A	145A	170A	150A	145A	145A
5.0	220A	210A	215A	170A		

REMARKS / APPLICATION ADVICE

Redry electrodes 2-4h 350 ±25°C after removal from cardboard boxes

Baso[®] 26V

CLASSIFICATION

AWS A5.1	E7048 H8	A-Nr	1
ISO 2560-A	E 42 3 B 1 5 H10	F-Nr	4
		9606 FM	1

GENERAL DESCRIPTION

Basic low hydrogen electrode

Specially developed for vertical down welding on shipyards and light general construction works

Complete fusion in open root passes

Good tack weldability

Good slag removal, smooth bead appearance

WELDING POSITIONS (ISO/ASME)



PA/1G



PB/2F



PC/2G



PF/3Gu



PG/3Gd



PE/4G

CURRENT TYPE

AC / DC +/-

APPROVALS

ABS	BV	DNV	LR	GL	RMRS
3Y	3Y	3YH10	3,3YH10	3YH10	3,3YH10

CHEMICAL COMPOSITION (W%), TYPICAL, ALL WELD METAL

C	Mn	Si	HDM
0.09	1.1	0.7	6 ml/100 g

MECHANICAL PROPERTIES, TYPICAL, ALL WELD METAL

Condition	Yield strength (N/mm ²)	Tensile strength (N/mm ²)	Elongation (%)	Impact ISO-V(J)	
				-20°C	-29°C/-30°C
Required: AWS A5.1 ISO 2560-A	min. 400	min. 490	min. 22		min. 27
Typical values	AW 580	500-640 630	min. 20 26	130	min. 47

PACKAGING AND AVAILABLE SIZES

Carton + PE foil	Diameter (mm)	3.2	4.0	5.0
	Length (mm)	450	450	450
Pieces / unit	Net weight/unit (kg)	150	100	70
		6.1	6.2	6.7

Identification Imprint: 7048 / BASO 26V

Tip Color: dark green

Baso[®] 26: rev. C-EN25-01/02/16

All information in this data sheet is accurate to the best of our knowledge at the time of printing. Please refer to www.lincolnelectric.eu for any updated information.
Fumes: Safety Data Sheets (SDS) are available on our website.

Baso[®] 26V

EXAMPLES OF MATERIALS TO BE WELDED

Steel grades/Code	Type
General structural steels	
EN 10025	S185, S235, S275, S355
Ship plates	
ASTM A 131	Grade A, B, D, AH32 to EH36
Cast steels	
EN 10213-2	GP240R
Pipe material	
EN 10208-1	L210, L240, L290, L360
EN 10208-2	L240, L290, L360, L415, L445
API 5LX	X42, X46, X52, X60
EN 10216-1/	P235T1, P235T2, P275T1
EN 10217-1	P275T2, P355N
Boiler & pressure vessel steels	
EN 10028-2	P235GH, P265GH, P295GH, P355GH
Fine grained steels	
EN 10025 part 3	S275, S355, S420
EN 10025 part 4	S275, S355, S420

CALCULATION DATA

Sizes Diam. x length (mm)	Current range (A)	Current type	Arc time	Energy	Dep. rate	Weight/ 1000 pcs (kg)	Electrodes/ kg weldmetal B	kg electrodes/ kg weldmetal 1/N
			- per electrode at max. current - (S)*	E(kJ)	H(kg/h)			
3.2x450	110-140	DC+	51	181	1.5	34.0	48	1.62
4.0x450	155-185	DC+	70	315	2.1	59.7	24	1.44
5.0x450	195-225	DC+	86	435	2.7	92.9	15	1.43

*Stub end 35mm

WELDING PARAMETERS, OPTIMUM FILL PASSES

Diameter (mm)	Welding positions		
	PA/1G	PG/3Gdown	PE/4G
3.2	130A	130A	125A
4.0	145A	175A	165A
5.0	220A	220A	200A

REMARKS / APPLICATION ADVICE

Redry electrodes 2-4h 350 ±25°C after removal from cardboard boxes

CLASSIFICATION

AWS A5.1	E7018-1 H4	A-Nr	1
ISO 2560-A	E 42 4 B 3 2 H5	F-Nr	4
		9606 FM	1

GENERAL DESCRIPTION

Basic coated low-hydrogen welding electrode with very good welding properties giving a tough, crack resistant weld metal. Suitable for welding structural steel and high tensile ship plate with a minimum tensile strength of 500N/mm².

Smooth and stable arc.

The electrode is well suited for positional welding particularly vertical and overhead). Good slag removal even in narrow gaps. The weld metal provides high crack resistance and excellent impact toughness down to temperatures of -40°C.

WELDING POSITIONS (ISO/ASME)



PA/1G



PB/2F



PC/2G



PF/3Gu



PE/4G



PH/5Gu

CURRENT TYPE

AC / DC +

APPROVALS

ABS	BV	DNV	GL	TÜV	RINA
3H5, 3Y	3,3Y H	3 YH5	3YH5	+	3,3Y H

CHEMICAL COMPOSITION (W%), TYPICAL, ALL WELD METAL

C	Mn	Si	HDM
0.07	1.2	0.5	3 ml/100 g

MECHANICAL PROPERTIES, TYPICAL, ALL WELD METAL

	Condition	Yield strength (N/mm ²)	Tensile strength (N/mm ²)	Elongation (%)	Impact ISO-V(J)	
					-40°C	-46°C
Required: AWS A5.1		min. 399	min. 482	min. 22		27
ISO 2560-A		min. 420	500-640	min. 20	47	
Typical values	AW	436	533	29	100	90

PACKAGING AND AVAILABLE SIZES

	Diameter (mm)	2.5	3.2	3.2	4.0	4.0	5.0
	Length (mm)	350	350	450	350	450	450
Unit : Carton + PE foil	Pieces / unit	118	73	73	55	55	32
	Net weight/unit (kg)	2.69	2.51	3.285	2.81	3.66	3.36
Unit : Protech®	Pieces / unit	96	60	60	40	40	30
	Net weight/unit (kg)	2.16	2.09	2.75	2.05	2.73	3.13

Identification Imprint: 7018-1 VANDAL Tip Color: none

Vandal: rev. C-EN04-01/02/16

Vandal

MATERIALS TO BE WELDED

Steel grades/Code	Type
General structural steels	
EN 10025	S185, S235 J0 / J2 / JR, S275 J0 / J2 / JR, S355 J0 / J2 / JR / K2
Ship plates	
ASTM A 131	Grade A, B, D, E, AH32 up to and including EH36
Cast steels	
EN 10213-2	GP 240 GH, GP 280 GH
Pipe material	
EN 10208-1	L210 GA, L235 GA, L245 GA, L290 GA, L360 GA
EN 10208-2	L245 MB / NB, L290 MB / NB, L360 MB / NB / QB, L415 MB / NB / QB
API 5LX	X42, X46, X52, X56, X60, X65
EN 10216-1	P195 TR1 / TR2, P235 TR1 / TR2, P265 TR1 / TR2
EN 10216-2	P195 GH, P235 GH, P265 GH
EN 10216-3	P275 NL1 / NL2, P355 N / NH / NL1 / NL2
Boiler & pressure vessel steels	
EN 10028-2	P235GH, P265GH, P295GH, P355GH
Fine grained steels	
EN 10025 part 3	S275 N / NL, S355 N / NL, S420 N / NL
EN 10025 part 4	S275 M / ML, S355 M / ML, S420 M / ML
Others	
	Steel grades with equivalent requirements as per above classified per ASTM, JIS etc

CALCULATION DATA

Sizes Diam. x length (mm)	Current range (A)	Current max. (A)	Current type	Arc time - per electrode at max. current - (S)*	Energy E(kJ)	Dep. rate H(kg/h)	Weight/ 1000 pcs (kg)	Electrodes/ kg weldmetal B	kg electrodes/ kg weldmetal 1/N
2.5x350	70-90	110	DC+	44	137	1,0	22,8	83	1,90
3.2x350	100-130	140	DC+	56	216	1,3	34,4	50	1,72
3.2x450	100-135	140	DC+	68	269	1,4	45	37	1,67
4.0x350	130-180	200	DC+	59	312	1,8	51,1	34	1,76
4.0x450	130-190	200	DC+	77	421	1,9	66,5	24	1,62
5.0x450	220-260	280	DC+	88	709	2,6	105	16	1,67

*Stub end 35mm

WELDING PARAMETERS, OPTIMUM FILL PASSES

Diameter (mm)	Welding positions				
	PA/1G	PB/2F	PC/2G	PF/3Gup	PE/4G
2.5	80A	85A	85A	85A	80A
3.2	120A	115A	115A	115A	110A
4.0	170A	180A	180A	180A	160A
5.0	240A	250A	250A	250A	230A

REMARKS / APPLICATION ADVICE

Redry electrodes 2-4h 350 ±25°C after removal from cardboard boxes

CLASSIFICATION

AWS A5.1	E7018-1 H4R	A-Nr	1
ISO 2560-A	E 46 4 B 4 2 H5	F-Nr	4
		9606 FM	1

GENERAL DESCRIPTION

Basic very low hydrogen electrode (HDM<5 ml/100g)

Recovery 130%

Excellent weldability on DC+ in all positions, especially overhead and vertical up

Excellent impact toughness down to -40°C

Excellent X-ray soundness

WELDING POSITIONS (ISO/ASME)



PA/1G



PB/2F



PC/2G



PF/3Gu



PG/3Gd



PE/4G

CURRENT TYPE

DC +

APPROVALS

DNV

4YH5

CHEMICAL COMPOSITION (W%), TYPICAL, ALL WELD METAL

C	Mn	Si	HDM
0.05	1.3	0.3	4 ml/100 g

MECHANICAL PROPERTIES, TYPICAL, ALL WELD METAL

Condition	Yield strength (N/mm ²)	Tensile strength (N/mm ²)	Elongation (%)	Impact ISO-V(J)	
				-40°C	-46°C
Required: AWS A5.1	min. 400	min. 490	min. 22		min. 27
ISO 2560-A	min. 460	530-680	min. 20	min. 47	
Typical values AW	470	570	27	103	80

PACKAGING AND AVAILABLE SIZES

Carton + PE foil	Diameter (mm)	2.0	2.5	3.2	4.0	5.0
	Length (mm)	300	350	450	450	450
Pieces / unit	Net weight/unit (kg)	146	110	110	82	58
		1.9	2.5	5.7	6.0	6.3

Identification Imprint: 7018-1 / CONARC 48 Tip Color: orange

Conarc® 48: rev. C-EN26-01/02/16

All information in this data sheet is accurate to the best of our knowledge at the time of printing. Please refer to www.lincolnelectric.eu for any updated information.
Fumes: Safety Data Sheets (SDS) are available on our website.

Conarc® 48

EXAMPLES OF MATERIALS TO BE WELDED

Steel grades/Code	Type
General structural steels	
EN 10025	S185, S235, S275, S355
Ship plates	
ASTM A 131	Grade A, B, D, AH32 to EH40
Cast steels	
EN 10213-2	GP240R
Pipe material	
EN 10208-1	L210, L240, L290, L360
EN 10208-2	L240, L290, L360, L415, L445
API 5LX	X42, X46, X52, X60, X65
EN 10216-1	P235T1, P235T2, P275T1
EN 10217-1	P275T2, P355N
Boiler & pressure vessel steels	
EN 10028-2	P235GH, P265GH, P295GH, P355GH
Fine grained steels	
EN 10025 part 3	S275, S355, S420, S460
EN 10025 part 4	S275, S355, S420, S460

CALCULATION DATA

Sizes		Current type	Arc time - per electrode at max. current - [S]*	Energy E(kJ)	Dep. rate H(kg/h)	Weight/ 1000 pcs (kg)	Electrodes/ kg weldmetal B	kg electrodes/ kg weldmetal 1/N
Diam. x length (mm)	Current range (A)							
2.0x300	50-80	DC+	53	0.6	14.3	123	1.76	
2.5x350	80-110	DC+	64	0.8	23.1	67	1.55	
3.2x350	95-150	DC+	67	1.3	40.0	40	1.60	
3.2x450	95-150	DC+	-	-	-	-	-	
4.0x350	125-210	DC+	83	1.7	57.6	26	1.50	
4.0x450	125-210	DC+	95	1.8	73.4	21	1.54	
5.0x450	190-270	DC+						

*Stub end 35mm

REMARKS / APPLICATION ADVICE

Redry electrodes 2-4h 350 ±25°C after removal from cardboard boxes

CLASSIFICATION

AWS A5.1	E7018 H4	A-Nr	1
ISO 2560-A	E 46 3 B 4 2 H5	F-Nr	4
		9606 FM	1

GENERAL DESCRIPTION

Basic very low hydrogen electrode (HDM< 5 ml/100g)

Most suitable universal basic electrode for shipbuilding and light general construction work

Welding characteristics come very close to the welders ideal electrode

Almost no spatter, nice wetting and full weld pool control

One current setting for all positions possible

Perfect welding and 120% recovery contributes to high productivity

Also available in Protech™ Vacuum Pack

WELDING POSITIONS (ISO/ASME)



PA/1G



PB/2F



PC/2G



PF/3Gu



PH/5Gu



PE/4G

CURRENT TYPE

DC +

APPROVALS

ABS	BV	DNV	LR	GL	RMRS	RINA	TÜV
3H5, 3Y	3,3YH5	3YH5	3,3YH5	3YH5	3,3YH5	3,3YH5	+

CHEMICAL COMPOSITION (W%), TYPICAL, ALL WELD METAL

C	Mn	Si	P	S	HDM
0.09	1.1	0.6	0.015	0.010	4 ml/100 g

MECHANICAL PROPERTIES, TYPICAL, ALL WELD METAL

Condition	Yield strength (N/mm ²)	Tensile strength (N/mm ²)	Elongation (%)	Impact ISO-V(J)		
				-20°C	-30°C	-40°C
Required: AWS A5.1 ISO 2560-A	min. 400 min. 460	min. 483 530-680	min. 22 min. 20		min. 27 min. 47	27
Typical values	AW 480	560	28	140	120	80

PACKAGING AND AVAILABLE SIZES

	Diameter (mm) Length (mm)	2.5	3.2	3.2	4.0	4.0	5.0
		350	350	450	350	450	450
Carton + PE foil	Pieces / unit	118	120	115	93	93	62
	Net weight/unit (kg)	2.7	4.5	5.2	5.0	6.3	6.7
Protech™	Pieces / unit	88	59	-	42	-	-
	Net weight/unit (kg)	2.0	2.2	-	2.2	-	-

Identification Imprint: 7018 H4/ CONARC 49

Tip Color: none

Conarc® 49: rev. C-ENB0-01/02/16

Conarc® 49

EXAMPLES OF MATERIALS TO BE WELDED

Steel grades/Code	Type
General structural steels	
EN 10025	S185, S235, S275, S355
Ship plates	
ASTM A 131	Grade A, B, D, AH32 to EH40
Cast steels	
EN 10213-2	GP240R
Pipe material	
EN 10208-1	L210, L240, L290, L360
EN 10208-2	L240, L290, L360, L415
API 5LX	X42, X46, X52, X60, X65
EN 10216-1	P235T1, P235T2, P275T1
EN 10217-1	P275T2, P355N
Boiler & pressure vessel steels	
EN 10028-2	P235GH, P265GH, P295GH, P355GH
Fine grained steels	
EN 10025 part 3	S275, S355, S420, S460
EN 10025 part 4	S275, S355, S420, S460

CALCULATION DATA

Sizes		Current type	Arc time - per electrode at max. current - [S]*	Energy E[kJ]	Dep. rate H[kg/h]	Weight/ 1000 pcs [kg]	Electrodes/ kg weldmetal B	kg electrodes/ kg weldmetal 1/N
Diam. x length [mm]	Current range [A]							
2.5x350	70-80	DC+	58	120	0.85	23.1	73	1.7
3.2x350	110-130	DC+	68	194	1.3	36.8	41	1.5
4.0x450	140-180	DC+	98	429	1.8	69.5	20	1.4
5.0x450	160-240	DC+	117	619	2.3	107.3	13	1.4

*Stub end 35mm

WELDING PARAMETERS, OPTIMUM FILL PASSES

Diameter [mm]	Welding positions					
	PA/1G	PB/2F	PC/2G	PF/3Gup	PE/4G	PH/5Gup
2.5	95A	95A	90A	90A	85A	85A
3.2	140A	130A	130A	120A	120A	110A
4.0	180A	180A	180A	160A	150A	160A
5.0	230A	230A	230A	180A		

REMARKS / APPLICATION ADVICE

Redry electrodes 2-4h 350 ±25°C after removal from cardboard boxes

CLASSIFICATION

AWS A5.1	E7018-1 H4R	A-Nr	1
ISO 2560-A	E 46 4 B 3 2 H5	F-Nr	4
		9606 FM	1

GENERAL DESCRIPTION

Basic extremely low hydrogen electrode
 Reliable impact toughness -40°C, good CTOD at -10°C
 The off-shore electrode when Ni-alloying is not allowed
 100 - 120% recovery
 Good pipe welding properties
 Excellent X-ray soundness
 Also available in vacuum sealed Sahara ReadyPack®(SRP)

WELDING POSITIONS (ISO/ASME)



PA/1G



PB/2F



PC/2G



PF/3Gu



PH/5Gu



PE/4G

CURRENT TYPE

AC/DC +/-

APPROVALS

ABS	BV	DNV	LR	GL	RMRS	TÜV
3H,3Y	3YHH	3YH5	3,3YH5	3YH10	3,3YH5	+

CHEMICAL COMPOSITION (W%), TYPICAL, ALL WELD METAL

C	Mn	Si	P	S	HDM
0.06	1.4	0.3	0.015	0.010	2 ml/100 g

MECHANICAL PROPERTIES, TYPICAL, ALL WELD METAL

Condition	Yield strength (N/mm ²)	Tensile strength (N/mm ²)	Elongation (%)	Impact ISO-V(J)		
				-20°C	-50°C	-46°/-50°C
Required: AWS A5.1	min. 400	min. 490	min. 22			min. 27
ISO 2560-A	min. 460	530-680	min. 20		min. 47	
Typical values	AW 480	580	28	200	170	100

Suitable for both As Welded and Stress Relieve (PWHT) conditions
 CTOD value at -10°C > 0.25mm

PACKAGING AND AVAILABLE SIZES

	Diameter (mm)	Length (mm)							
			2.5	3.0	3.2	3.2	4.0	4.0	5.0
			350	350	350	450	350	450	450
Carton + PE foil	Pieces / unit	Net weight/unit (kg)	135	80	120	120	85	85	55
			2.7	2.4	4.4	5.8	4.7	5.9	6.0
SRP	Pieces / unit	Net weight/unit (kg)	70	-	50	50	28	28	23
			1.4	-	2.0	2.5	1.6	2.0	2.6

Identification Imprint: 7018-1/CONARC 49C Tip Color: grey

Conarc® 49C.rev.C-ENZ-12/05/16

Conarc® 49C

EXAMPLES OF MATERIALS TO BE WELDED

Steel grades/Code	Type
General structural steels	
EN 10025	S185, S235, S275, S355
Ship plates	
ASTM A 131	Grade A, B, D, AH32 to EH40
Cast steels	
EN 10213-2	GP240R
Pipe material	
EN 10208-1	L210, L240, L290, L360
EN 10208-2	L240, L290, L360, L415, L445
API 5LX	X42, X46, X52, X60, X65
EN 10216-1	P235T1, P235T2, P275T1
EN 10217-1	P275T2, P355N
Boiler & pressure vessel steels	
EN 10028-2	P235GH, P265GH, P295GH, P355GH
Fine grained steels	
EN 10025 part 3	S275, S355, S420, S460
EN 10025 part 4	S275, S355, S420, S460

CALCULATION DATA

Sizes Diam. x length [mm]	Current range [A]	Current type	Arc time	Energy	Dep. rate	Weight/ 1000 pcs [kg]	Electrodes/ kg weldmetal/ B	kg electrodes/ kg weldmetal 1/N
			- per electrode at max. current - [S]*	E[kJ]	H[kg/h]			
2.5x350	55-80	DC+	55	99	0.78	19.6	84	1.65
3.0x350	70-110	DC+	53	193	1.2	30.4	58	1.77
3.2x350	80-130	DC+	65	217	1.2	37.9	45	1.69
4.0x350	120-160	DC+	75	348	1.6	54.2	30	1.61
4.0x450	120-160	DC+	100	444	1.7	70.4	21	1.47
5.0x450	180-240	DC+	90	632	2.6	105.6	15	1.60

*Stub end 35mm

WELDING PARAMETERS, OPTIMUM FILL PASSES

Diameter [mm]	Welding positions					
	PA/1G	PB/2F	PC/2G	PF/3Gup	PE/4G	PH/5Gup
2.5	80A	80A	80A	85A	80A	80A
3.0	110A	110A	115A	110A	105A	110A
3.2	140A	120A	145A	120A	120A	120A
4.0	150A	140A	150A	140A	135A	140A
5.0	220A	210A	210A	170A		

REMARKS / APPLICATION ADVICE

Redry electrodes 2-4h 350 ±25°C after removal from cardboard boxes.
Best choice : 3.0 x 350mm for rootlayer welding in pipes.

CLASSIFICATION

AWS A5.1	E7018-1 H4R	A-Nr	1
ISO 2560-A	E 42 5 B 3 2 H5	F-Nr	4
		9606 FM	1

GENERAL DESCRIPTION

Basic extremely low hydrogen electrode
 Reliable impact toughness -40°C, good CTOD at -10°C
 The off-shore electrode when Ni-alloying is not allowed
 115 - 120% recovery
 Good pipe welding properties
 Excellent X-ray soundnessA
 Iso available in vacuum sealed Sahara ReadyPack® (SRP)

WELDING POSITIONS (ISO/ASME)



PA/1G



PB/2F



PC/2G



PF/3Gu



PH/5Gu



PE/4G

CURRENT TYPE

AC/DC +/-

APPROVALS

ABS	BV	DNV	LR	GL	RMRS	RINA	TÜV
3H,3Y	3YHH	3YH5	3,3YH5	3YH10	3,3YH5	4YH5	+

CHEMICAL COMPOSITION (W%), TYPICAL, ALL WELD METAL

C	Mn	Si	P	S	HDM
0.05	1.3	0.4	0.015	0.010	3 ml/100 g

MECHANICAL PROPERTIES, TYPICAL, ALL WELD METAL

Condition	Yield strength [N/mm ²]	Tensile strength [N/mm ²]	Elongation [%]	Impact ISO-V(J)			
				-20°C	-40°C	-46°C	-50°C
Required: AWS A5.1 ISO 2560-A	min. 400 min. 420	min. 490 500-640	min. 22 min. 20			min. 27	min. 27
Typical values AW	480	575	28	200	120	100	80

CTOD value at -10°C > 0.25mm

PACKAGING AND AVAILABLE SIZES

	Diameter (mm) Length (mm)	2.5	3.2	4.0	5.0
			350	450	450
Carton + PE foil	Pieces / unit	110	120	85	55
	Net weight/unit (kg)	7.5	7.7	8.3	8.2
SRP	Pieces / unit	60	50	28	23
	Net weight/unit (kg)	1.4	2.5	2.0	2.5

Identification Imprint: 7018-1 / CONARC ONE Tip Color: blue

Conarc® ONE: rev. C-EN04-01/02/16

All information in this data sheet is accurate to the best of our knowledge at the time of printing. Please refer to www.lincolnelectric.eu for any updated information.
 Fumes: Safety Data Sheets (SDS) are available on our website.

Conarc® ONE

EXAMPLES OF MATERIALS TO BE WELDED

Steel grades/Code	Type
General structural steels	
EN 10025	S185, S235, S275, S355
Ship plates	
ASTM A 131	Grade A, B, D, AH32 to EH40
Cast steels	
EN 10213-2	GP240R
Pipe material	
EN 10208-1	L210, L240, L290, L360
EN 10208-2	L240, L290, L360, L415, L445
API 5LX	X42, X46, X52, X60, X65
EN 10216-1	P235T1, P235T2, P275T1
EN 10217-1	P275T2, P355N
Boiler & pressure vessel steels	
EN 10028-2	P235GH, P265GH, P295GH, P355GH
Fine grained steels	
EN 10025 part 3	S275, S355, S420, S460
EN 10025 part 4	S275, S355, S420, S460

CALCULATION DATA

Sizes Diam. x length (mm)		Current range (A)	Current type	Arc time - per electrode at max. current - (S)*	Energy E(kJ)	Dep. rate H(kg/h)	Weight/ 1000 pcs (kg)	Electrodes/ kg weldmetal B	kg electrodes/ kg weldmetal 1/N
2.5x350		60-100	DC+	60	138	0.83	23.1	72	1.67
3.2x450		90-145	DC+	93	337	1.27	50.8	30	1.54
4.0x450		110-160	DC+	103	464	1.65	71.2	21	1.52
5.0x450		160-250	DC+	177	717	2.24	108.8	14	1.49

*Stub end 35mm

WELDING PARAMETERS, OPTIMUM FILL PASSES

Diameter (mm)	Welding positions					
	PA/1G	PB/2F	PC/2G	PF/3Gup	PE/4G	PH/5Gup
2.5	90A	90A	85A	90A	85A	80A
3.2	140A	140A	150A	120A	115A	120A
4.0	175A	175A	170A	150A	145A	145A
5.0	230A	230A	215A	170A		

REMARKS / APPLICATION ADVICE

Redry electrodes 2-4h 350 ±25°C after removal from cardboard boxes

CLASSIFICATION

AWS A5.1	E7018-1 H4	A-Nr	1
ISO 2560-A	E 46 5 B 4.2 H5	F-Nr	4
		9606 FM	1

GENERAL DESCRIPTION

Basic very low hydrogen electrode
Excellent for general purpose welding
Good impact values down to -50°C
Also available in Protech™ Vacuum Pack

WELDING POSITIONS (ISO/ASME)



PA/1G



PB/2F



PC/2G



PF/3Gu



PH/5Gu



PE/4G

CURRENT TYPE

DC +

APPROVALS

ABS	BV	DNV/ GL	LR	TÜV
4Y40H5	4Y40HHH	4Y40H5	4Y40H5	Pending

CHEMICAL COMPOSITION (W%), TYPICAL, ALL WELD METAL

C	Mn	Si	HDM
0.05	1.0	0.3	4 ml/100 g

MECHANICAL PROPERTIES, TYPICAL, ALL WELD METAL

Condition	Yield strength (N/mm ²)	Tensile strength (N/mm ²)	Elongation (%)	Impact ISO-V(J)			
				-30°C	-40°C	-46°C	-50°C
Required: AWS A5.1	min. 400	min. 482	min. 22			min. 27	
ISO 2560-A	min. 460	530-680	min. 20		min. 47		
Typical values							
AW	500	600	27	150	120	100	90
SR:1h/600°C	480	580	29	120		50	

PACKAGING AND AVAILABLE SIZES

	Diameter (mm)	2,5	3,2	3,2	4,0	4,0	5,0
	Length (mm)	350	350	450	350	450	450
Carton + PE foil	Pieces / unit	195	135	135	92	92	66
	Net weight/unit (kg)	4.3	4.7	6.1	4.7	5.9	6.7
Protech™	Pieces / unit	90	58	58	45	45	33
	Net weight/unit (kg)	2.0	2.0	2.6	2.3	3.0	3.3

Identification Imprint: 7018-1 H4 / CONARC 50 Tip Color: none

Conarc® 50: rev. C-EN09-23/05/16

Conarc[®] 50

EXAMPLES OF MATERIALS TO BE WELDED

Steel grades/Code	Type
General structural steels	
EN 10025	S185, S235, S275, S355
Ship plates	
ASTM A 131	Grade A, B, D, AH32 to EH40
Cast steels	
EN 10213-2	GP240R
Pipe material	
EN 10208-1	L210, L240, L290, L360
EN 10208-2	L240, L290, L360, L415
API 5LX	X42, X46, X52, X60
EN 10216-1	P235T1, P235T2, P275T1
EN 10217-1	P275T2, P355N
Boiler & pressure vessel steels	
EN 10028-2	P235GH, P265GH, P295GH, P355GH
Fine grained steels	
EN 10025 part 3	S275, S355, S420
EN 10025 part 4	S275, S355, S420

CALCULATION DATA

Sizes Diam. x length (mm)	Current range (A)	Current type	Arc time	Energy	Dep. rate	Weight/ 1000 pcs (kg)	Electrodes/ kg weldmetal B	kg electrodes/ kg weldmetal 1/N
			- per electrode at max. current - [S]*	E(kJ)	H(kg/h)			
2.5x350	70-90	-	-	-	-	-	-	-
3.2x350	100-130	-	-	-	-	-	-	-
3.2x450	100-135	-	-	-	-	-	-	-
4.0x350	130-180	-	-	-	-	-	-	-
4.0x450	130-190	-	-	-	-	-	-	-
5.0x450	220-260	-	-	-	-	-	-	-

*Stub end 35mm

WELDING PARAMETERS, OPTIMUM FILL PASSES

Diameter (mm)	Welding positions					
	PA/1G	PB/2F	PC/2G	PF/3Gup	PE/4G	PH/5Gup
2.5	80A	85A	85A	85A	80A	85A
3.2	120A	115A	115A	115A	110A	115A
4.0	170A	180A	180A	180A	160A	
5.0	240A	250A	250A	250A	230A	

REMARKS / APPLICATION ADVICE

Redry electrodes 2-4h 350 ±25°C after removal from cardboard boxes

CLASSIFICATION

AWS A5.1	E7016-1 H4R	A-Nr	1
ISO 2560-A	E 42 4 B 12 H5	F-Nr	4
		9606 FM	1

GENERAL DESCRIPTION

Basic extremely low hydrogen electrode
 Good impact values down to -40 °C
 Good CTOD at -10°C, meets offshore requirements
 Excellent root pass electrode (diam. 2.5 and 3.2 mm)
 Also available in vacuum sealed Sahara ReadyPack® (SRP): HDM< 3 ml/100g

WELDING POSITIONS (ISO/ASME)

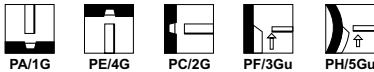

CURRENT TYPE

AC/DC +/-

APPROVALS

ABS	BV	DNV	LR	GL	TÜV
3H,3Y	3,3YHH	3YH5	3,3YH5	3YH10	+

CHEMICAL COMPOSITION (W%), TYPICAL, ALL WELD METAL

C	Mn	Si	P	S	HDM
0.06	1.4	0.5	0.015	0.010	2 ml/100 g

MECHANICAL PROPERTIES, TYPICAL, ALL WELD METAL

Condition	Yield strength (N/mm ²)	Tensile strength (N/mm ²)	Elongation (%)	Impact ISO-V(J)		
				-20°C	-40°C	-46°C
Required: AWS A5.1 ISO 2560-A Typical values	min. 400 min. 420	min. 490 500-640	min. 22 min. 20			
AW	520	575	28	115	min. 47 80	min. 27 60

CTOD value at -10°C > 0.25mm

PACKAGING AND AVAILABLE SIZES

	Diameter (mm)	Length (mm)					
		2.5	3.2	3.2	4.0	4.0	5.0
Carton + PE foil	Pieces / unit	136	150	-	100	-	-
	Net weight/unit (kg)	2.7	4.7	-	4.6	-	-
SRP	Pieces / unit	70	56	56	-	30	23
	Net weight/unit (kg)	1.4	1.8	2.3	-	1.8	2.6

Identification Imprint: 7016-1 / CONARC 51 Tip Color: gold

Conarc® 51: rev. C-EN27-01/02/16

Conarc® 51

EXAMPLES OF MATERIALS TO BE WELDED

Steel grades/Code	Type
General structural steels	
EN 10025	S185, S235, S275, S355
Ship plates	
ASTM A 131	Grade A, B, D, AH32 to EH40
Cast steels	
EN 10213-2	GP240R
Pipe material	
EN 10208-1	L210, L240, L290, L360
EN 10208-2	L240, L290, L360, L415, L445
API 5LX	X42, X46, X52, X60
EN 10216-1	P235T1, P235T2, P275T1
EN 10217-1	P275T2, P355N
Boiler & pressure vessel steels	
EN 10028-2	P235GH, P265GH, P295GH, P355GH
Fine grained steels	
EN 10025 part 3	S275, S355, S420
EN 10025 part 4	S275, S355, S420

CALCULATION DATA

Sizes Diam. x length (mm)	Current range (A)	Current type	Arc time	Energy	Dep. rate	Weight/ 1000 pcs (kg)	Electrodes/ kg weldmetal B	kg electrodes/ kg weldmetal 1/N
			- per electrode at max. current - (S)*	E(kJ)	H(kg/h)			
2.5x350	40-80	DC+	53	123	0.8	19.6	86	1.68
3.2x350	70-120	DC+	62	178	1.0	30.8	57	1.74
3.2x450	70-120							
4.0x350	100-160	DC+	71	306	1.4	48.0	37	1.78
4.0x450	100-160							
5.0x450	180-240	DC+	104	702	2.6	103.0	13	1.36

*Stub end 35mm

WELDING PARAMETERS, OPTIMUM FILL PASSES

Diameter (mm)	Welding positions				
	PA/1G	PC/2G	PF/3Gup	PE/4G	PH/5Gup
2.5	75A	70A	75A	70A	75A
3.2	100A	110A	100A	100A	100A
4.0	150A	140A	130A	125A	125A
5.0	220A	220A	180A		

REMARKS / APPLICATION ADVICE

Redry electrodes 2-4h 350 ±25°C after removal from cardboard boxes

CLASSIFICATION

AWS A5.1	E7016	A-Nr	1
ISO 2560-A	E 42 2 B 12 H5	F-Nr	4
		9606 FM	1

GENERAL DESCRIPTION

Designed for vertical up root pass welding of pipes up to and including X80 and similar steel
 Suitable for fill and cap pass welding for up to and including X65
 Excellent low temperature impact properties down to -30°C
 Good directed arc even at very low current makes welding easier, especially in critical pipe welding applications
 Superior crack resistance, excellent stability in all welding positions
 Open gap root pass welding with 2.5 and 3.2 mm electrodes using DC - / + polarity

WELDING POSITIONS (ISO/ASME)



PA/1G



PB/2F



PC/2G



PF/3Gu



PH/5Gu



PE/4G

CURRENT TYPE

AC/DC +/-

CHEMICAL COMPOSITION (W%), TYPICAL, ALL WELD METAL

C	Mn	Si	P	S	HDM
0.06	1.2	0.4	0.015	0.010	4 ml/100 g

MECHANICAL PROPERTIES, TYPICAL, ALL WELD METAL

Condition	Yield strength (N/mm ²)	Tensile strength (N/mm ²)	Elongation (%)	Impact ISO-V(J)	
				-20°C	-29°/-30°C
Required: AWS A5.1 ISO 2560-A Typical values	min. 400 min. 420 510	min. 490 500-640 560	min. 22 min. 20 28	27 100	min. 47 80

PACKAGING AND AVAILABLE SIZES

Carton + PE foil	Diameter (mm)	2.5	3.2	4.0
	Length (mm)	350	350	350
Pieces / unit Net weight/unit (kg)	Diameter (mm)	148	157	87
		Length (mm)	2.7	4.8

Conarc® 52

EXAMPLES OF MATERIALS TO BE WELDED

Steel grades/Code	Type
General structural steels	
EN 10025	S185, S235, S275, S355
Ship plates	
ASTM A 131	Grade A, B, D, AH32 to EH40
Cast steels	
EN 10213-2	GP240R
Pipe material	
EN 10208-1	L210, L240, L290, L360
EN 10208-2	L240, L290, L360, L415, L445
API 5LX	X42, X46, X52, X60
EN 10216-1	P235T1, P235T2, P275T1
EN 10217-1	P275T2, P355N
Boiler & pressure vessel steels	
EN 10028-2	P235GH, P265GH, P295GH, P355GH
Fine grained steels	
EN 10025 part 3	S275, S355, S420
EN 10025 part 4	S275, S355, S420

CALCULATION DATA

Sizes Diam. x length (mm)	Current range (A)	Current type	Arc time	Energy	Dep. rate	Weight/ 1000 pcs (kg)	Electrodes/ kg weldmetal B	kg electrodes/ kg weldmetal 1/N
			- per electrode at max. current - [S]*	E[kJ]	H(kg/h)			
2.5x350	50-80	DC+	59	100.6	0.71	18.5	86	1.59
3.2x350	60-120	DC+	68	179.9	1.02	30.3	52	1.57
4.0x350	120-170	DC+	77	258.7	1.50	48.7	31	1.51

*Stub end 35mm

WELDING PARAMETERS, OPTIMUM FILL PASSES

Diameter (mm)	Welding positions					
	PA/1G	PB/2F	PC/2G	PF/3Gup	PE/4G	PH/5Gup
2.5	85A	85A	85A	75A	85A	75A
3.2	120A	115A	115A	115A	115A	115A
4.0	170A	170A	170A	140A	140A	140A

REMARKS / APPLICATION ADVICE

Redry electrodes 2-4h 350 ±25°C after removal from cardboard boxes

Lincoln® 7018-1

CLASSIFICATION

AWS A5.1	E7018-1	A-Nr	1
ISO 2560-A	E 42 4 B 3 2 H5	F-Nr	4
		9606 FM	1

GENERAL DESCRIPTION

Basic very low hydrogen electrode
Excellent for general purpose welding
Good impact values down to -46°C

WELDING POSITIONS (ISO/ASME)



PA/1G



PB/2F



PC/2G



PF/3Gu



PE/4G

CURRENT TYPE

AC / DC + / -

APPROVALS

ABS	BV	DNV	LR	GL	RINA	TÜV
4Y40H5	4Y40HHH	4Y40H5	4Y40H5	+	4Y40H5	+

CHEMICAL COMPOSITION (W%), TYPICAL, ALL WELD METAL

C	Mn	Si	P	S
0.05	1.0	0.3	0.015	0.010

MECHANICAL PROPERTIES, TYPICAL, ALL WELD METAL

Condition	Yield strength (N/mm ²)	Tensile strength (N/mm ²)	Elongation (%)	Impact ISO-V(J)	
				-40°C	-46°C
Required: AWS A5.1 ISO 2560-A Typical values	min. 400 min. 420	min. 490 500-640	min. 22 min. 20	min. 47 100	min. 27 90
AW	436	533	29		

PACKAGING AND AVAILABLE SIZES

	Diameter (mm) Length (mm)	2.5	3.2	3.2	4.0	4.0	5.0
		350	350	450	350	450	450
Carton + PE foil	Pieces / unit	175	115	115	80	80	55
	Net weight/unit (kg)	3.9	4.0	5.2	4.1	5.3	5.6
Protech™	Pieces / unit	90	58	-	40	-	-
	Net weight/unit (kg)	2.0	2.0	-	2.0	-	-

Identification Imprint: 7018-1 / LINCOLN 7018-1 Tip Color: none

Lincoln® 7018-1: rev. C-EN26-01/02/16

All information in this data sheet is accurate to the best of our knowledge at the time of printing. Please refer to www.lincolnelectric.eu for any updated information.
Fumes: Safety Data Sheets (SDS) are available on our website.

Lincoln® 7018-1

EXAMPLES OF MATERIALS TO BE WELDED

Steel grades/Code	Type
General structural steels	
EN 10025	S185, S235, S275, S355
Ship plates	
ASTM A 131	Grade A, B, D, AH32 to EH40
Cast steels	
EN 10213-2	GP240R
Pipe material	
EN 10208-1	L210, L240, L290, L360
EN 10208-2	L240, L290, L360, L415
API 5LX	X42, X46, X52, X60
EN 10216-1	P235T1, P235T2, P275T1
EN 10217-1	P275T2, P355N
Boiler & pressure vessel steels	
EN 10028-2	P235GH, P265GH, P295GH, P355GH
Fine grained steels	
EN 10025 part 3	S275, S355, S420
EN 10025 part 4	S275, S355, S420

CALCULATION DATA

Sizes Diam. x length (mm)		Current range (A)	Current type	Arc time - per electrode at max. current - (S)*	Energy E(kJ)	Dep. rate H(kg/h)	Weight/ 1000 pcs (kg)	Electrodes/ kg weldmetal B	kg electrodes/ kg weldmetal 1/N
2.5x350		70-90	DC+	59	132	0.9	22.3	71	1.59
3.2x350		100-130	DC+	65	221	1.2	34.8	48	1.66
3.2x450		100-135	DC+	75	272	1.4	45.2	36	1.61
4.0x350		130-180	DC+	64	313	1.9	51.3	29	1.51
4.0x450		130-190	DC+	77	410	2.2	66.3	21	1.41
5.0x450		220-260	DC+	84	657	3.0	101.8	14	1.43

*Stub end 35mm

WELDING PARAMETERS, OPTIMUM FILL PASSES

Diameter (mm)	Welding positions				
	PA/1G	PB/2F	PC/2G	PF/3Gup	PE/4G
2.5	80A	85A	85A	85A	80A
3.2	120A	115A	115A	115A	110A
4.0	170A	180A	180A	180A	160A
5.0	240A	250A	250A	250A	230A

REMARKS / APPLICATION ADVICE

Redry electrodes 2-4h 350 ±25°C after removal from cardboard boxes

Conarc® L150

CLASSIFICATION

AWS A5.1	E7028 H4R	A-Nr	1
ISO 2560-A	E 42 2 B 5 3 H5	F-Nr	1
		9606 FM	1

GENERAL DESCRIPTION

Basic low hydrogen electrode (HDM<5 ml/100g)

150% recovery

Easy slag release

Fillet welds and horizontal V- and X-welds

Excellent weldability on AC and DC

Transformers with OCV > 70V recommended

Also available in vacuum sealed Sahara ReadyPack®(SRP)

WELDING POSITIONS (ISO/ASME)



PA/1G



PB/2F



PC/2G

CURRENT TYPE

AC/DC + / -

APPROVALS

ABS	BV	DNV	LR	GL	TÜV
3H,3Y	3,3YH	3YH5	3,3YH15	3YH10	+

CHEMICAL COMPOSITION (W%), TYPICAL, ALL WELD METAL

C	Mn	Si	P	S	HDM
0.07	0.95	0.4	0.015	0.010	4 ml/100 g

MECHANICAL PROPERTIES, TYPICAL, ALL WELD METAL

Condition	Yield strength (N/mm ²)	Tensile strength (N/mm ²)	Elongation (%)	Impact ISO-V(J)
				-18°C/-20°C
Required: AWS A5.1 ISO 2560-A Typical values	min. 400 min. 420 540	min. 490 500-640 580	min. 22 min. 20 27	min. 27 min. 47 75

PACKAGING AND AVAILABLE SIZES

	Diameter (mm)	3.2	4.0	5.0
	Length (mm)	450	450	450
Carton + PE foil	Pieces / unit	90	55	35
	Net weight/unit (kg)	5.9	5.3	5.2
SRP	Pieces / unit	-	21	-
	Net weight/unit (kg)	-	2.1	-

Identification Imprint: 7028 / CONARC L150 Tip Color: yellow

Conarc®L150: rev. C-EN26-01/02/16

All information in this data sheet is accurate to the best of our knowledge at the time of printing. Please refer to www.lincolnelectric.eu for any updated information.
Fumes: Safety Data Sheets (SDS) are available on our website.

Conarc® L150

EXAMPLES OF MATERIALS TO BE WELDED

Steel grades/Code	Type
General structural steels	
EN 10025	S185, S235, S275, S355
Ship plates	
ASTM A 131	Grade A, B, D, AH32 to EH40
Cast steels	
EN 10213-2	GP240R
Pipe material	
EN 10208-1	L210, L240, L290, L360
EN 10208-2	L240, L290, L360, L415, L445
API 5LX	X42, X46, X52, X60
EN 10216-1	P235T1, P235T2, P275T1
EN 10217-1	P275T2, P355N
Boiler & pressure vessel steels	
EN 10028-2	P235GH, P265GH, P295GH, P355GH
Fine grained steels	
EN 10025 part 3	S275, S355, S420
EN 10025 part 4	S275, S355, S420

CALCULATION DATA

Sizes		Current type	Arc time - per electrode at max. current - (S)*	Energy E(kJ)	Dep. rate H(kg/h)	Weight/ 1000 pcs (kg)	Electrodes/ kg weldmetal B	kg electrodes/ kg weldmetal 1/N
Diam. x length (mm)	Current range (A)							
3.2x450	140-160	AC/DC+	84	375	1.7	64.8	26	1.67
4.0x450	175-220	AC/DC+	80	555	2.6	97.8	17	1.69
5.0x450	275-325	AC/DC+	75	838	4.4	155.7	11	1.72
6.0x450	325-350	AC/DC+	85	1260	5.4	209.4	8	1.64

*Stub end 35mm

WELDING PARAMETERS, OPTIMUM FILL PASSES

Diameter (mm)	Welding positions		
	PA/1G	PB/2F	PC/2G
3.2	150A	150A	140A
4.0	210A	200A	190A
5.0	310A	280A	
6.0	360A	300A	

REMARKS / APPLICATION ADVICE

Redry electrodes 2-4h 350 ±25°C after removal from cardboard boxes Transformers with OCV > 70 V recommended

CLASSIFICATION

AWS A5.1	E7028 H4R	A-Nr	1
ISO 2560-A	E 42 4 B 7 3 H5	F-Nr	1
		9606 FM	1

GENERAL DESCRIPTION

Basic extremely low hydrogen electrode (HDM<3 ml/100g)
175% recovery and easy slag release
Fillet welds and horizontal V- and X-welds
Reliable impact toughness down to -40°C, good CTOD at -10°C
Excellent X-ray quality
Also available in vacuum sealed Sahara ReadyPack® [SRP]

WELDING POSITIONS (ISO/ASME)



PA/1G



PB/2F



PC/2G

CURRENT TYPE

AC/DC + / -

APPROVALS

ABS	BV	DNV	LR	GL	RINA	RMRS
3YH5	3,3YHH	3YH5	3,3YH5	3YH10	3YH5	3-3YH5

CHEMICAL COMPOSITION (W%), TYPICAL, ALL WELD METAL

C	Mn	Si	P	S	HDM
0.08	1.2	0.3	0.015	0.010	2 ml/100 g

MECHANICAL PROPERTIES, TYPICAL, ALL WELD METAL

Condition	Yield strength (N/mm ²)	Tensile strength (N/mm ²)	Elongation (%)	Impact ISO-V(J)	
				-18°C/-20°C	-40°C
Required: AWS A5.1 ISO 2560-A	min. 400 min. 420	min. 490 500-640	min. 22 min. 20	min. 27	min. 47
Typical values CTOD value at -10°C > 0.25mm	AW 440	510	30	130	80

PACKAGING AND AVAILABLE SIZES

	Diameter (mm) Length (mm)	3.2	4.0	5.0	6.3
		450	450	450	450
Carton + PE foil	Pieces / unit	-	60	40	23
	Net weight/unit (kg)	-	6.0	6.1	5.4
SRP	Pieces / unit	27	23	19	-
	Net weight/unit (kg)	2.0	2.4	2.8	-

Identification Imprint: 7028 / CONARC V180

Tip Color: white

Conarc® V180: rev. C-EN24-01/02/16

All information in this data sheet is accurate to the best of our knowledge at the time of printing. Please refer to www.lincolnelectric.eu for any updated information.
Fumes: Safety Data Sheets (SDS) are available on our website.

Conarc® V180

EXAMPLES OF MATERIALS TO BE WELDED

Steel grades/Code	Type
General structural steels	
EN 10025	S185, S235, S275, S355
Ship plates	
ASTM A 131	Grade A, B, D, AH32 to EH40
Cast steels	
EN 10213-2	GP240R
Pipe material	
EN 10208-1	L210, L240, L290, L360
EN 10208-2	L240, L290, L360, L415, L445
API 5LX	X42, X46, X52, X60
EN 10216-1	P235T1, P235T2, P275T1
EN 10217-1	P275T2, P355N
Boiler & pressure vessel steels	
EN 10028-2	P235GH, P265GH, P295GH, P355GH
Fine grained steels	
EN 10025 part 3	S275, S355, S420
EN 10025 part 4	S275, S355, S420

CALCULATION DATA

Sizes Diam. x length (mm)	Current range (A)	Current type	Arc time	Energy	Dep. rate	Weight/ 1000 pcs (kg)	Electrodes/ kg weldmetal B	kg electrodes/ kg weldmetal 1/N
			- per electrode at max. current - (S)*	E(kJ)	H(kg/h)			
3.2x450	130-160	AC	73	337	2.3	68.9	21	1.47
4.0x450	170-240	AC	70	538	3.6	101.0	14	1.45
5.0x450	275-330	AC	75	780	4.9	149.7	10	1.45
6.3x450	280-425	AC	83	1171	7.0	230.4	6	1.43

*Stub end 35mm

WELDING PARAMETERS, OPTIMUM FILL PASSES

Diameter (mm)	Welding positions		
	PA/1G	PB/2F	PC/2G
3.2	160A	140A	140A
4.0	230A	190A	190A
5.0	300A	230A	230A
6.3	390A	280A	

REMARKS / APPLICATION ADVICE

Redry electrodes 2-4h 350 ±25°C after removal from cardboard boxes Transformers with OCV > 70 V recommended

CLASSIFICATION

AWS A5.1	E 6018 ¹⁾	A-Nr	1
ISO 2560-A	E 35 2 B 3 2 H5	F-Nr	4
¹⁾ according to classification 1966		9606 FM	1

GENERAL DESCRIPTION

Basic extremely low hydrogen electrode (HDM<3 ml/100g)
 Repairs and tie-ins in oil and gas transport pipe lines
 Low yield and ultimate tensile strength, high impact toughness
 Buffer layer electrode for internally clad stainless steel
 Only available in vacuum sealed Sahara ReadyPack® (SRP)

WELDING POSITIONS (ISO/ASME)

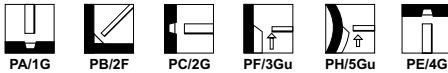

CURRENT TYPE

AC/DC +/-

CHEMICAL COMPOSITION (W%), TYPICAL, ALL WELD METAL

C	Mn	Si	P	S	HDM
0.03	0.4	0.25	0.015	0.010	3 ml/100 g

MECHANICAL PROPERTIES, TYPICAL, ALL WELD METAL

Condition	Yield strength (N/mm ²)	Tensile strength (N/mm ²)	Elongation (%)	Impact ISO-V(J)
				-18°C/-20°C
Required: AWS A5.1 ISO 2560-A	min. 331	min. 414	min. 22	min. 27
Typical values AW	min. 355 390	440-570 450	min. 22 28	>200

PACKAGING AND AVAILABLE SIZES

	Diameter (mm)	2.5	3.2	4.0
	Length (mm)	350	350	350
SRP	Pieces / unit	23	17	28
	Net weight/unit (kg)	0.5	0.7	1.5

Identification Imprint: KARDD Tip Color: black

Kardo® rev. C-EN25-01/02/16

All information in this data sheet is accurate to the best of our knowledge at the time of printing. Please refer to www.lincolnelectric.eu for any updated information.
 Fumes: Safety Data Sheets (SDS) are available on our website.

Kardo®**EXAMPLES OF MATERIALS TO BE WELDED**

Weld the buffer layer of CrNi- and CrNiMo-stainless clad steel with one side welding.
 High strength Fine grained steels as S460 for NH₃ storage tanks, to weld very soft, ferritic cap layers
 Pipe line steel grades, to weld low yield strength fillet welds in split-T-joints (system Nederlandse Gasunie)
 API 5L: X52 - X65 (EN 10208: L360 to L460).

CALCULATION DATA

Sizes Diam. x length (mm)	Current range (A)	Current type	Arc time	Energy	Dep. rate	Weight/ 1000 pcs (kg)	Electrodes/ kg weldmetal B	kg electrodes/ kg weldmetal 1/N
			- per electrode at max. current - [S]*	E[kJ]	H[kg/h]			
2.5x350	60-80	DC+	81	173	0.5	19.7	81	1.60
3.2x350	90-120	DC+	84	252	1.0	36.5	43	1.58
4.0x350	120-160	DC+	79	448	1.6	53.0	29	1.56

*Stub end 35mm

WELDING PARAMETERS, OPTIMUM FILL PASSES

Diameter (mm)	Welding positions					
	PA/1G	PB/2F	PC/2G	PF/3Gup	PE/4G	PH/5Gup
2.5	80A	80A	80A	85A	80A	80A
3.2	140A	120A	145A	120A	120A	120A
4.0	150A	140A	150A	140A	135A	140A

REMARKS / APPLICATION ADVICE

Use electrodes directly from Sahara ReadyPack.
 Restrict dilution on stainless steel root runs.

Shield Arc® HYP+

CLASSIFICATION

AWS A5.5	E 7010-P1	A-Nr	1
ISO 2560-A	E 42 2 Mo C 2 5	F-Nr	3
		9606 FM	1

GENERAL DESCRIPTION

Cellulosic electrode for vertical down pipe welding
 Suitable for pipe with strengths X52 through X65
 Cleaner weld puddle
 Very low tendency to peel or flake off under high electrode pressure in tight joints
 Low susceptibility to wagon tracks, windows and pinholes
 Very low spatter and smoother arc action

APPROVALS

TÜV	ABS
+	+

WELDING POSITIONS (ISO/ASME)



P/J5Gd

CURRENT TYPE

DC +

CHEMICAL COMPOSITION (W%), TYPICAL, ALL WELD METAL

C	Mn	Si	Mo	V
0.13-0.17	0.49-0.63	0.08-0.18	0.27-0.31	<0.01

MECHANICAL PROPERTIES, TYPICAL, ALL WELD METAL

Condition	Yield strength (N/mm ²)	Tensile strength (N/mm ²)	Elongation (%)	Impact ISO-V(J)	
				-20°C	-29°C
Required: AWS A5.5 ISO 2560-A Typical values	min. 415 min. 420 435-525	min. 490 500-640 525-635	min. 22 min. 20 24	min. 47	min. 27 50

PACKAGING AND AVAILABLE SIZES

	Diameter (mm)	Length (mm)	Pieces / unit		
			3.2	4.0	4.8
Metal can			873	561	388
	Net weight/unit (kg)		22.7	22.7	22.7

Identification Imprint: 7010-P1 Tip Color: none

Shield Arc®HYP+; rev. C-EN07-01/02/16

Shield Arc® HYP+

EXAMPLES OF MATERIALS TO BE WELDED

Steel grades/Code	Type
Pipe material	
EN 10208-2	L360 , L415, L445
EN 10216-1 / 10217-1	P355
API 5LX	X52, X56, X60, X65
Gaz de France	X52, X63

CALCULATION DATA

Sizes Diam. x length (mm)	Current range (A)	Current type	Weight/ 1000 pcs (kg)
3.2x355	75-130	DC+	26
4.0x355	90-185	DC+	40.4
4.8x355	140-225	DC+	58.5

*Stub end 35mm

WELDING PARAMETERS, OPTIMUM FILL PASSES

Diameter (mm)	Welding positions PJ/5Gdown
3.2	75-130A
4.0	90-185A
4.8	140-225A

REMARKS / APPLICATION ADVICE

Preheating pipe material from L380 to L450 (X56 to X65) required (acc.EN 1011-1).
 Pipeclamps to be removed after finishing root pass, start welding hot pass (within 5 min) after root pass
 Use electrodes directly from metal cans
 Use Fleetweld 5P+ for lower hardness in the root pass.

Shield Arc® 70+

CLASSIFICATION

AWS A5.5	E8010-G	A-Nr	10
ISO 2560-A	E 46 4 1Ni C 2 5	F-Nr	3
		9606 FM	2

GENERAL DESCRIPTION

Cellulosic coated electrode for vertical down pipe welding
 Suitable for pipe with strengths in the range of X56 - X70
 Metal can be used for root, fill and capping passes
 Low susceptibility to wagon tracks, windows and pinholes
 Good impact values
 Metal can be used for silicon-killed steels

WELDING POSITIONS (ISO/ASME)



P/J/5Gd

CURRENT TYPE

DC +

APPROVALS

TÜV	ABS
+	+

CHEMICAL COMPOSITION (W%), TYPICAL, ALL WELD METAL

C	Mn	Si	Ni	Cr	Mo	V
0.13-0.17	0.6-1.2	0.05-0.3	0.75-0.97	0.01-0.2	0.05-0.15	0.02-0.04

MECHANICAL PROPERTIES, TYPICAL, ALL WELD METAL

Condition	Yield strength (N/mm ²)	Tensile strength (N/mm ²)	Elongation (%)	Impact ISO-V(J)		
				-29°C	-40°C	-46°C
Required: AWS A5.5 ISO 2560-A	min. 460	min. 550	min. 19			
Typical values	AW	460-620	530-680	min. 20	min. 47	
		585-680	24	75		60

PACKAGING AND AVAILABLE SIZES

	Diameter (mm)	3.2	4.0	4.8
	Length (mm)	355	355	355
Metal can	Pieces / unit	873	561	388
	Net weight/unit (kg)	22.7	22.7	22.7

Identification Imprint: 8010-G

Tip Color: none

Shield Arc70+ rev. C-ENZ-01/02/16

Shield Arc® 70+

EXAMPLES OF MATERIALS TO BE WELDED

Steel grades/Code	Type
Pipe material	
EN 10208-2	L360 , L415, L445, L480
EN 10216-1 / 10217-1	P355
API 5LX	X56, X60, X65, X70
Gaz de France	X52, X63

CALCULATION DATA

Sizes Diam. x length (mm)	Current range (A)	Current type	Weight/ 1000 pcs (kg)
3.2x355	75-130	DC+	26
4.0x355	90-185	DC+	40.4
4.8x355	140-225	DC+	58.5

*Stub end 35mm

WELDING PARAMETERS, OPTIMUM FILL PASSES

Diameter (mm)	Welding positions PJ/5Gdown
3.2	75-130A
4.0	90-185A
4.8	140-225A

Conarc® 55CT

EMR SAHARA®

SMAW

CLASSIFICATION

AWS A5.5	E8018-W2-H4R ¹⁾	A-Nr	10	¹⁾ Deviation, see remarks - ²⁾ Nearest classification
ISO 2560-A	E 46 5 MnNi B 3 2 H5 ²⁾	F-Nr	4	
		9606 FM	2	

GENERAL DESCRIPTION

All position electrode for welding weather resistant steel like Cor-Ten, Patinax etc...
 Basic extremely low hydrogen electrode
 Excellent mechanical properties (impact down to -50°C)
 Also available in vacuum sealed Sahara ReadyPack® [SRP]: HDM < 3 ml/100g

WELDING POSITIONS (ISO/ASME)



PA/1G



PB/2F



PC/2G



PF/3Gu



PE/4G



PH/5Gu

CURRENT TYPE

AC / DC +/-

APPROVALS

LR

4Y42H5

CHEMICAL COMPOSITION (W%), TYPICAL, ALL WELD METAL

C	Mn	Si	P	S	Ni	Cu	HDM
0.05	1.5	0.4	0.010	0.015	0.9	0.4	3 ml/100 g

MECHANICAL PROPERTIES, TYPICAL, ALL WELD METAL

Condition	0.2% Proof strength (N/mm ²)	Tensile strength (N/mm ²)	Elongation (%)	Impact ISO-V(J)			
				-18°C	-20°C	-40°C	-50°C
Required: AWS A5.5 ISO 2560-A Typical values	min. 460 min. 460	min. 550 530-680	min. 19 min. 20 25	min. 27			
AW	540	610			115	100	min. 47 60

PACKAGING AND AVAILABLE SIZES

	Diameter (mm)	2,5	3,2	4,0
	Length (mm)	350	350	350
Carton + PE foil	Pieces / unit	140	120	-
	Net weight/unit (kg)	2.7	4.5	-
SRP	Pieces / unit	69	50	27
	Net weight/unit (kg)	1.4	1.9	1.5

Identification Imprint: CONARC 55CT Tip Color: black

Conarc® 55CT; rev. C-EN28-01/02/16

All information in this data sheet is accurate to the best of our knowledge at the time of printing. Please refer to www.lincolnelectric.eu for any updated information.
 Fumes: Safety Data Sheets (SDS) are available on our website.

Conarc® 55CT

EXAMPLES OF MATERIALS TO BE WELDED

Steel grades/Code	Type
Weather resisting steels EN 10025-5	S235 J0W
	S235 J2W
	S355 J0W
	S355 J2W
	S355 K2G1W

Weather resistant steels like Cor-Ten®, Patinax®, Patinax®-F, Patinax®-37 and similar Ni- and Cu-alloyed steels

CALCULATION DATA

Sizes Diam. x length (mm)	Current range (A)	Current type	Arc time - per electrode at max. current - (S)*	Energy E(kJ)	Dep. rate H(kg/h)	Weight/ 1000 pcs (kg)	Electrodes/ kg weldmetal B	kg electrodes/ kg weldmetal 1/N
2.5x350	55-85	DC+	53	81	0.77	19.7	88	1.74
3.2x350	80-145	DC+	70	223	1.2	36.9	43	1.60
4.0x350	120-185	DC+	77	355	1.6	54.1	29	1.59
5.0x450	180-270	DC+	104	784	2.4	105.2	15	1.53

*Stub end 35mm

WELDING PARAMETERS, OPTIMUM FILL PASSES

Diameter (mm)	Welding positions					
	PA/1G	PB/2F	PC/2G	PF/3Gup	PE/4G	PH/5Gup
2.5	110A	110A	115A	110A	105A	110A
3.2	140A	120A	145A	120A	120A	120A
4.0	150A	140A	150A	140A	135A	140A
5.0	220A	210A	210A	170A		

REMARKS / APPLICATION ADVICE

Redry electrodes 2-4h 350 ±25°C after removal from cardboard boxes

Deviations: chemical composition:

Mn = 1.4 - 1.9%

Si = 0.15 - 0.60%

Cr = 0.1%

Ni = 0.7 - 1.0%

Cu = 0.3 - 0.5%

AWS: Mn = 0.50 - 1.30%

AWS: Si = 0.35 - 0.80%

AWS: Cr = 0.45 - 0.70%

AWS: Ni = 0.40 - 0.80%

EN: Cu max. 0.3%

Conarc® 60G

EMR
SAHARA®

CLASSIFICATION

AWS A5.5	E9018M-H4	A-Nr	10
ISO 18275-A	E 55 4 Z B 32 H5	F-Nr	4
		9606 FM	2

GENERAL DESCRIPTION

Basic all position extremely low hydrogen electrode (HDM< 2 ml/100g)

For welding high strength steel grades (UTS 540-640 N/mm²)

Good impact values down to -51°C DC welding preferred

115 - 120% recovery

Also available in vacuum sealed Sahara ReadyPack® (SRP)

WELDING POSITIONS (ISO/ASME)



PA/1G



PB/2F



PC/2G



PF/3Gu



PE/4G



PH/5Gu

CURRENT TYPE

AC / DC +/-

APPROVALS

ABS	BV	DNV	GL	LR	TÜV
3Y	4Y50	4Y50H5	4YH10	+	+

CHEMICAL COMPOSITION (W%), TYPICAL, ALL WELD METAL

C	Mn	Si	P	S	Ni	Mo	HDM
0.06	1.0	0.4	0.015	0.010	1.6	0.3	2 ml/100 g

MECHANICAL PROPERTIES, TYPICAL, ALL WELD METAL

Condition	0.2% Proof strength [N/mm ²]	Tensile strength [N/mm ²]	Elongation [%]	Impact ISO-V(J)		
				-20°C	-40°C	-51°C
Required: AWS A5.5	540-620*	min. 620	min. 24			min. 27
ISO 18275-A	min. 550	610-780	min. 18		min. 47	
Typical values	AW	600	670	25	98	
	SR:1h/620°C	550	640	24	90	40

* Dia.2.5 mm max 655 N/mm²

PACKAGING AND AVAILABLE SIZES

	Diameter (mm)	Length (mm)	Carton + PE foil		SRP	
			Pieces / unit	Net weight/unit (kg)	Pieces / unit	Net weight/unit (kg)
	2.5	350	-	-	65	1.4
	3.2	350	-	-	50	2.0
	4.0	350	85	4.6	28	1.5
	5.0	450	55	5.8	23	2.6

Identification Imprint: 9018-M / CONARC 60G Tip Color: red

Conarc® 60G: rev. C-EN25-01/02/16

All information in this data sheet is accurate to the best of our knowledge at the time of printing. Please refer to www.lincolnelectric.eu for any updated information. Fumes: Safety Data Sheets (SDS) are available on our website.

Conarc® 60G

EXAMPLES OF MATERIALS TO BE WELDED

Steel grades/Code	Type
General structural steels	
EN 10025	S355
Pipe material	
EN 10208-2	L360, L415, L445, L480
API 5LX	X52, X56, X60, X65, X70
EN 10216-1/EN10217-1	P235T1, P235T2, P275T1, P275T2, P355N
Fine grained steels	
EN 10025 part 4	S420M (L), S460M (L), S420N (L), S460N (L)
EN 10025 part 6	S460, S500
Weather resisting steels	
EN 10155	S235 J0W S235 J2W S355 J0W S355 J2W S355 K2G1W

CALCULATION DATA

Sizes		Current type	Arc time - per electrode at max. current - [S]*	Energy E(kJ)	Dep. rate H(kg/h)	Weight/ 1000 pcs (kg)	Electrodes/ kg weldmetal B	kg electrodes/ kg weldmetal 1/N
Diam. x length (mm)	Current range (A)							
2.5x350	60-100	DC+	63	114	0.7	23.5	77	1.80
3.2x350	80-130	DC+	69	231	1.3	38.3	40	1.52
4.0x350	120-180	DC+	72	324	1.7	55.8	30	1.66
5.0x450	160-240	DC+	119	760	2.2	105.2	14	1.43

*Stub end 35mm

WELDING PARAMETERS, OPTIMUM FILL PASSES

Diameter (mm)	Welding positions					
	PA/1G	PB/2F	PC/2G	PF/3Gup	PE/4G	PH/5Gup
2.5	80A	75A	80A	85A	75A	75A
3.2	130A	120A	135A	120A	115A	120A
4.0	155A	145A	160A	145A	140A	140A
5.0	225A	220A	210A			

REMARKS / APPLICATION ADVICE

Redry electrodes 2-4h 350 ±25°C after removal from cardboard boxes

CLASSIFICATION

AWS A5.5	E9018-G-H4R	A-Nr	10
ISO 18275-A	E 55 4 1NiMo B 3 2 H5	F-Nr	4
		9606 FM	2

GENERAL DESCRIPTION

Basic all position extremely low hydrogen electrode [HDM < 2 ml/100g]
 For high strength steel grades (UTS 640-735 N/mm²), root passes in HY 100 steel
 Good impact values down to -40°C DC welding preferred
 115 - 120% recovery
 Also available in vacuum sealed Sahara ReadyPack® (SRP)

WELDING POSITIONS (ISO/ASME)



PA/1G



PB/2F



PC/2G



PF/3Gu



PE/4G



PH/5Gu

CURRENT TYPE

AC / DC +/-

APPROVALS

DNV TÜV

4Y50H5 +

CHEMICAL COMPOSITION (W%), TYPICAL, ALL WELD METAL

C	Mn	Si	P	S	Ni	Mo	HDM
0.06	1.2	0.4	0.014	0.009	1.0	0.4	2 ml/100 g

MECHANICAL PROPERTIES, TYPICAL, ALL WELD METAL

	Condition	0.2% Proof strength (N/mm ²)	Tensile strength (N/mm ²)	Elongation [%]	Impact ISO-V(J)		
					-20°C	-40°C	-46°C
Required: AWS A5.5		min. 530	min. 620	min. 17	not required		
ISO 18275-A		min. 550	610-780	min. 18	min. 47		
Typical values	AW	600	655	24	90	90	60
	SR:15h/580°C	550	640	24	90		50

PACKAGING AND AVAILABLE SIZES

	Diameter (mm)	2.5	3.2	4.0	4.0	5.0
	Length (mm)	350	350	350	450	450
Carton + PE foil	Pieces / unit	110	120	85	-	55
	Net weight/unit (kg)	2.5	4.6	4.6	-	5.8
SRP	Pieces / unit	64	50	28	28	23
	Net weight/unit (kg)	1.5	2.0	1.5	2.0	2.4

Identification Imprint: 9018-G / CONARC 70G Tip Color: light green

Conarc® 70G: rev. C-EN24-01/02/16

All information in this data sheet is accurate to the best of our knowledge at the time of printing. Please refer to www.lincolnelectric.eu for any updated information.
 Fumes: Safety Data Sheets (SDS) are available on our website.

Conarc® 70G

SMAW

EXAMPLES OF MATERIALS TO BE WELDED

Steel grades/Code	Type
Boiler & pressure vessel steels (Reactor steels incl. Q & T steels)	
DIN	20MnMoNi5-5, 22NiMoCr3-7 15NiCuMoNb5-6-4 G5-18NiMoCr3-7
ASTM	A508CL2, A508CL3 A533CL1Gr.B / C A533CL2Gr.B / C
Creep resistant steels	
	15NiCuMoNb-5 (WB36) 1.6368 17MnMoV6-4(WB35) 1.5403
Pipe material	
EN 10208-2	L480, L550
API 5LX	X65, X70 (X80 root run)
Fine grained steels	
EN 10025 part 6	S460, S500, S550 Root runs and fillet welds in S620 and S690

CALCULATION DATA

Sizes Diam. x length (mm)	Current range (A)	Current type	Arc time	Energy	Dep. rate	Weight/ 1000 pcs (kg)	Electrodes/ kg weldmetal B	kg electrodes/ kg weldmetal 1/N
			- per electrode at max. current - (S)*	E(kJ)	H(kg/h)			
2.5x350	60-100	DC+	67	121	0.7	19.5	75	1.47
3.2x350	80-130	DC+	70	234	1.3	37.5	41	1.56
4.0x350	120-180	DC+	74	343	1.7	55.4	29	1.59
5.0x450	160-240	DC+	106	573	2.5	106.4	14	1.43

*Stub end 35mm

WELDING PARAMETERS, OPTIMUM FILL PASSES

Diameter (mm)	Welding positions					
	PA/1G	PB/2F	PC/2G	PF/3Gup	PE/4G	PH/5Gup
2.5	80A	75A	80A	85A	75A	75A
3.2	130A	120A	135A	120A	115A	120A
4.0	155A	145A	160A	145A	140A	140A
5.0	225A	220A	210A			

REMARKS / APPLICATION ADVICE

Redry electrodes 2-4h 350 ±25°C after removal from cardboard boxes

CLASSIFICATION

AWS A5.5	E8018-G-H4R	A-Nr	10
ISO 2560-A	E 50 6 Mn1Ni B 3 2 H5	F-Nr	4
		9606 FM	2

GENERAL DESCRIPTION

The basic all position pipeline and offshore electrode with max. 1% Ni
 Excellent mechanical properties (impact down to -60°C)
 Extremely low hydrogen content
 110 - 120% recovery
 Weldable on AC and DC

WELDING POSITIONS (ISO/ASME)



PA/1G



PB/2F



PC/2G



PF/3Gu



PE/4G



PH/5Gu

CURRENT TYPE

AC / DC +/-

APPROVALS

NAKS

Pending

CHEMICAL COMPOSITION (W%), TYPICAL, ALL WELD METAL

C	Mn	Si	P	S	Ni	HDM
0.05	1.5	0.5	0.010	0.005	0.95	2 ml/100 g

MECHANICAL PROPERTIES, TYPICAL, ALL WELD METAL

Condition	0.2% Proof strength (N/mm ²)	Tensile strength (N/mm ²)	Elongation (%)	Impact ISO-V(J)	
				-40°C	-60°C
Required: AWS A5.5	min. 460	min. 550	min. 19	not required	
ISO 2560-A	min. 500	560-720	min. 18	min. 47	
Typical values AW	550	640	24	140	80

CTOD value at -10°C > 0.25 mm

PACKAGING AND AVAILABLE SIZES

Carton + PE foil	Diameter (mm)	3.2	4.0
	Length (mm)	350	450
Pieces / unit	Net weight/unit (kg)	120	85
		4.7	5.9

Identification Imprint: 8018-G / CONARC 74 Tip Color: white

Conarc® 74: rev. C-EN05-01/02/16

All information in this data sheet is accurate to the best of our knowledge at the time of printing. Please refer to www.lincolnelectric.eu for any updated information.
 Fumes: Safety Data Sheets (SDS) are available on our website.

Conarc® 74

EXAMPLES OF MATERIALS TO BE WELDED

Steel grades/Code	Type
General structural steels	
EN 10025	S275, S355
Ship plates	
ASTM A 131	Grade A, B, D, AH32 to EH40
Cast steels	
EN 10213-2	GP240R
Pipe material	
EN 10208-1	L290 GA, L360 GA
EN 10208-2	L290, L360, L415, L445
API 5LX	X42, X46, X52, X60, X65
EN 10216-1/EN 10217-1	P275T1, P275T2, P355N
Fine grained steels	
EN 10025 part 3	S275, S355, S420, S460
EN 10025 part 4	S275, S355, S420, S460
EN 10025 part 6	S460

CALCULATION DATA

Sizes Diam. x length (mm)	Current range (A)	Current type	Arc time	Energy	Dep. rate	Weight/ 1000 pcs (kg)	Electrodes/ kg weldmetal B	kg electrodes/ kg weldmetal 1/N
			- per electrode at max. current - (S)*	E(kJ)	H(kg/h)			
2.5x350	55-80	DC+	59	85	0.72	19.3	86	1.65
3.2x350	80-145	DC+	66	220	1.2	37.7	48	1.79
4.0x350	120-185	DC+	77	355	1.6	54.1	29	1.59
4.0x450	120-185	DC+	90	450	1.8	68.4	23	1.56
5.0x450	180-240	DC+	104	784	2.4	105.2	15	1.53

*Stub end 35mm

WELDING PARAMETERS, OPTIMUM FILL PASSES

Diameter (mm)	Welding positions					
	PA/1G	PB/2F	PC/2G	PF/3Gup	PE/4G	PH/5Gup
2.5	80A	80A	80A	80A	80A	80A
3.2	140A	120A	145A	120A	120A	120A
4.0	150A	140A	150A	140A	135A	140A

REMARKS / APPLICATION ADVICE

Redry electrodes 2-4h 350 ±25°C after removal from cardboard boxes

CLASSIFICATION

AWS A5.5	E11018M-H4	A-Nr	10
ISO 18275-A	E 69 5 Z B 3 2 H5	F-Nr	4
		9606 FM	2

GENERAL DESCRIPTION

Basic all position extremely low hydrogen electrode (HDM< 2 ml/100g)

Weldable on AC and DC

110 - 115% recovery

Good impact values down to -51°C

Meets the requirements of military specifications

Suitable for welding submarines high strength steels (UTS up to 800 N/mm²)

Also available in vacuum sealed Sahara ReadyPack® (SRP)

WELDING POSITIONS (ISO/ASME)



PA/1G



PB/2F



PC/2G



PF/3Gu



PE/4G



PH/5Gu

CURRENT TYPE

AC / DC +/-

APPROVALS

ABS

LR

CCS

+

4Y69H5

4Y69H5

CHEMICAL COMPOSITION (W%), TYPICAL, ALL WELD METAL

C	Mn	Si	P	S	Ni	Mo	HDM
0.06	1.5	0.4	0.015	0.01	2.2	0.4	2 ml/100 g

MECHANICAL PROPERTIES, TYPICAL, ALL WELD METAL

Condition	0.2% Proof strength [N/mm ²]	Tensile strength [N/mm ²]	Elongation [%]	Impact ISO-V(J)		
				-40°C	-50°C	-51°C
Required: AWS A5.5	680-760*	min. 760	min. 20			min. 27
ISO 18275-A	min. 690	760-960	min. 17		min. 47	
Typical values	AW	750	785	22	100	80

* Diam.2.5 max.795 N/mm²

SR:14h/620°C

PACKAGING AND AVAILABLE SIZES

	Diameter (mm) Length (mm)	2.5	3.2	4.0	5.0
		350	350	350	450
Carton + PE foil	Pieces / unit	-	120	90	60
	Net weight/unit (kg)	-	4.5	5.0	6.3
SRP	Pieces / unit	70	50	28	23
	Net weight/unit (kg)	1.4	1.9	1.5	2.5

Identification Imprint: 11018-M / CONARC 80 Tip Color: gold

Conarc® 80: rev. C-EN25-12/01/16

Conarc® 80

EXAMPLES OF MATERIALS TO BE WELDED

Steel grades/Code	Type
Pipe material	
API 5LX	X70, X75
Fine grained steels	
EN 10025 part 6	S620, S690
	Root runs and fillet welds in S890

SMAW

CALCULATION DATA

Sizes		Current type	Arc time - per electrode at max. current - [S]*	Energy E(kJ)	Dep. rate H(kg/h)	Weight/ 1000 pcs (kg)	Electrodes/ kg weldmetal B	kg electrodes/ kg weldmetal 1/N
Diam. x length (mm)	Current range (A)							
2.5x350	60-80	DC+	55	99	0.8	19.5	82	1.61
3.2x350	80-130	DC+	78	261	1.1	36.5	43	1.55
4.0x350	120-180	DC+	75	356	1.6	53.2	30	1.59
5.0x450	160-240	DC+	116	627	2.3	105.1	14	1.45

*Stub end 35mm

WELDING PARAMETERS, OPTIMUM FILL PASSES

Diameter (mm)	Welding positions					
	PA/1G	PB/2F	PC/2G	PF/3Gup	PE/4G	PH/5Gup
2.5	75A	75A	75A	80A	75A	80A
3.2	130A	120A	135A	120A	115A	120A
4.0	145A	145A	155A	140A	140A	140A
5.0	225A	230A	210A			

REMARKS / APPLICATION ADVICE

Redry electrodes 2-4h 350 ±25°C after removal from cardboard boxes

Conarc® 85

EMR
SAHARA®

SMAW

CLASSIFICATION

AWS A5.5	E12018-G-H4R	A-Nr	10
ISO 18275-A	E 69 5 Mn2NiCrMo B 3 2 H5	F-Nr	4
		9606 FM	2

GENERAL DESCRIPTION

Basic all position extremely low hydrogen electrode (HDM < 2 ml/100g)

For steels with a tensile strength UTS of max. 835 N/mm²

For high strength steels such as T1, HY 100, Naxtra 70, HRS 650, Dillimax. 690

Good impact values down to -50°C

Only available in vacuum sealed Sahara ReadyPack® (SRP)

WELDING POSITIONS (ISO/ASME)



PA/1G



PB/2F



PC/2G



PF/3Gu



PE/4G



PH/5Gu

CURRENT TYPE

AC / DC +/-

APPROVALS

ABS

DNV

CCS

+

4Y69H5

4Y69H5

CHEMICAL COMPOSITION (W%), TYPICAL, ALL WELD METAL

C	Mn	Si	P	S	Ni	Mo	Cr	HDM
0.06	1.4	0.3	0.010	0.010	2.0	0.4	0.4	2 ml/100 g

MECHANICAL PROPERTIES, TYPICAL, ALL WELD METAL

Condition	0.2% Proof strength (N/mm ²)	Tensile strength (N/mm ²)	Elongation (%)	Impact ISO-V(J)	
				-40°C	-50°C
Required: AWS A5.5 ISO 18275-A	min. 740	min. 830	min. 14	not required	
Typical values	min. 690	760-960	min. 17		min. 47
AW	840	890	21	80	60
SR:1h/620°C	780	840	20	75	60

PACKAGING AND AVAILABLE SIZES

SRP	Diameter (mm)	2,5	3,2	4,0	4,0	5,0
	Length (mm)	350	350	350	450	450
Pieces / unit		68	50	28	28	23
	Net weight/unit (kg)	1.4	1.9	1.5	1.9	2.5

Identification Imprint: 12018-G / CONARC 85

Tip Color: light blue

Conarc® 85 rev. C-EN29-12/05/16

All information in this data sheet is accurate to the best of our knowledge at the time of printing. Please refer to www.lincolnelectric.eu for any updated information.
Fumes: Safety Data Sheets (SDS) are available on our website.

Conarc® 85

EXAMPLES OF MATERIALS TO BE WELDED

Steel grades/Code	Type
Pipe material API 5LX	X70, X75, X80
Fine grained steels EN 10025 part 6	S690 Root runs and fillet welds in S890

CALCULATION DATA

Sizes Diam. x length (mm)	Current range (A)	Current type	Arc time	Energy	Dep. rate	Weight/ 1000 pcs (kg)	Electrodes/ kg weldmetal	kg electrodes/ kg weldmetal
			- per electrode at max. current - (S)*	E(kJ)	H(kg/h)		B	1/N
3.2x350	80-130	DC+	69	219	1.0	375	50	1.89
4.0x350	120-180	DC+	68	321	1.5	53.2	35	1.87
5.0x450	160-240	DC+	106	632	2.0	106.7	17	1.81

*Stub end 35mm

WELDING PARAMETERS, OPTIMUM FILL PASSES

Diameter (mm)	Welding positions					
	PA/1G	PB/2F	PC/2G	PF/3Gup	PE/4G	PH/5Gup
2.5	75A	75A	75A	80A	75A	80A
3.2	135A	130A	140A	120A	120A	120A
4.0	155A	145A	155A	140A	140A	140A
5.0	225A	220A	215A			

CLASSIFICATION

AWS A5.5	E7018-G-H4R ¹⁾	A-Nr	10
ISO 2560-A	E 50 6 Mn1Ni B 3 2 H5	F-Nr	4
¹⁾ meet also AWS A5.5:E8018-G-H4R		9606 FM	2

GENERAL DESCRIPTION

The basic all position offshore electrode with max. 1% Ni
Excellent mechanical properties (impact down to -60°C)

Good CTOD down to -10°C

Extremely low hydrogen content

110 - 120% recovery

Weldable on AC and DC, also available in vacuum sealed Sahara ReadyPack[®] [SRP]: HDM < 3 ml/100g

WELDING POSITIONS (ISO/ASME)



PA/1G



PB/2F



PC/2G



PF/3Gu



PE/4G



PH/5Gu

CURRENT TYPE

AC / DC +/-

APPROVALS

ABS	BV	DNV	LR	GL	RINA	RMRS	TÜV
3Y	UP	5Y46H5	5Y40H5	6Y46H10	4YH5	3-3YH5	+

CHEMICAL COMPOSITION (W%), TYPICAL, ALL WELD METAL

C	Mn	Si	P	S	Ni	HDM
0.05	1.5	0.4	0.010	0.010	0.9	2 ml/100 g

MECHANICAL PROPERTIES, TYPICAL, ALL WELD METAL

Condition	0.2% Proof strength (N/mm ²)	Tensile strength (N/mm ²)	Elongation (%)	Impact ISO-V(J)	
				-20°C	-60°C
Required: AWS A5.5	min. 390	min. 480	min. 25	not required	
ISO 2560-A	min. 500	560-720	min. 18		min. 47
Typical values	550	640	24	150	90
AW	460	550	24		90
SR:580°C/15h					

CTOD value at -10°C > 0.25 mm

PACKAGING AND AVAILABLE SIZES

	Diameter (mm)	Length (mm)	2.5				3.0		3.2		4.0		5.0	
			350	350	350	450	350	450	450	450	350	450	350	450
Carton + PE foil	Pieces / unit		135	-	130	120	85	85	-	-	-	-	-	-
	Net weight/unit (kg)		2.7	-	4.7	5.8	4.4	5.9	-	-	-	-	-	-
SRP	Pieces / unit		70	54	50	50	28	28	23					
	Net weight/unit (kg)		1.4	1.5	1.9	2.4	1.5	2.0	2.5					

Identification Imprint: 7018-G / KRVO 1 Tip Color: purple

Kryo[®] 1: rev. C-EN26-12/05/16

Kryo[®] 1

SMAW

EXAMPLES OF MATERIALS TO BE WELDED

Steel grades/Code	Type
General structural steels	
EN 10025	S275, S355
Ship plates	
ASTM A 131	Grade A, B, D, AH32 to EH40
Cast steels	
EN 10213-2	GP240R
Pipe material	
EN 10208-1	L290 GA, L360 GA
EN 10208-2	L290, L360, L415, L445
API 5LX	X42, X46, X52, X60, X65, X70
EN 10216-1	P275T1
EN 10217-1	P275T2, P355N
Fine grained steels	
EN 10025 part 3	S275, S355, S420, S460
EN 10025 part 4	S275, S355, S420, S460
EN 10025 part 6	S460

CALCULATION DATA

Sizes		Current type	Arc time - per electrode at max. current - (S)*	Energy E(kJ)	Dep. rate H(kg/h)	Weight/ 1000 pcs (kg)	Electrodes/ kg weldmetal B	kg electrodes/ kg weldmetal 1/N
Diam. x length (mm)	Current range (A)							
2.5x350	55-80	DC+	59	85	0.72	19.3	86	1.65
3.0x350	70-110	DC+	74	256	0.93	30.2	52	1.58
3.2x350	80-140	DC+	66	220	1.2	37.7	48	1.79
3.2x450	80-140	DC+	78	259	1.3	48.7	35	1.72
4.0x350	120-170	DC+	77	355	1.6	54.1	29	1.59
4.0x450	120-170	DC+	90	450	1.8	68.4	23	1.56
5.0x450	180-240	DC+	104	784	2.4	105.2	15	1.53

*Stub end 35mm

WELDING PARAMETERS, OPTIMUM FILL PASSES

Diameter (mm)	Welding positions					
	PA/1G	PB/2F	PC/2G	PF/3Gup	PE/4G	PH/5Gup
2.5	80A	80A	80A	80A	80A	80A
3.0	110A	110A	115A	110A	105A	110A
3.2	140A	120A	145A	120A	120A	120A
4.0	150A	140A	150A	140A	135A	140A
5.0	220A	210A	210A	170A		

REMARKS / APPLICATION ADVICE

Redry electrodes 2-4h 350 ±25°C after removal from cardboard boxes

Kryo[®] 1N

EMR SAHARA[®]

SMAW

CLASSIFICATION

AWS A5.5	E 8016-G-H4R	A-Nr	10
ISO 2560-A	E 50 6 Mn1Ni B 12 H5	F-Nr	4
		9606 FM	2

GENERAL DESCRIPTION

The basic all position offshore electrode with max. 1% Ni
 Thin coated electrode, easy weld pool control
 Excellent mechanical properties (impact down to -60°C)
 Good CTOD at -10°C
 Extremely low hydrogen content
 Weldable on AC and DC
 Only available in vacuum sealed Sahara ReadyPack[®] (SRP): HDM < 3 ml/100g

WELDING POSITIONS (ISO/ASME)



PA/1G



PB/2F



PC/2G



PF/3Gu



PE/4G



PH/5Gu

CURRENT TYPE

AC / DC +/-

CHEMICAL COMPOSITION (W%), TYPICAL, ALL WELD METAL

C	Mn	Si	P	S	Ni	HDM
0.07	1.7	0.5	0.020	0.005	0.9	2 ml/100 g

MECHANICAL PROPERTIES, TYPICAL, ALL WELD METAL

Condition	0.2% Proof strength (N/mm ²)	Tensile strength (N/mm ²)	Elongation (%)	Impact ISO-V(J)	
				-40°C	-60°C
Required: AWS A5.5	min. 460	min. 550	min. 19	not required	
ISO 2560-A	min. 500	560-720	min. 18	min. 47	
Typical values AW	570	650	24	95	60

CTOD value at -10°C > 0.25 mm

PACKAGING AND AVAILABLE SIZES

SRP	Diameter (mm)	2,5	3,2	4,0	5,0
	Length (mm)	350	450	450	450
SRP	Pieces / unit	45	56	30	23
	Net weight/unit (kg)	0.9	2.3	1.9	2.3

Identification Imprint: 8016-G / KRYO 1N Tip Color: red

Kryo[®] 1N: rev. C-EN25-01/02/16

All information in this data sheet is accurate to the best of our knowledge at the time of printing. Please refer to www.lincolnelectric.eu for any updated information. Fumes: Safety Data Sheets (SDS) are available on our website.

Kryo® 1N

SMAW

EXAMPLES OF MATERIALS TO BE WELDED

Steel grades/Code	Type
General structural steels	
EN 10025	S275, S355
Ship plates	
ASTM A 131	Grade A, B, D, AH32 to EH40
Cast steels	
EN 10213-2	GP240R
Pipe material	
EN 10208-1	L290 GA, L360 GA
EN 10208-2	L290, L360, L415, L445
API 5LX	X42, X46, X52, X60, X65, X70
EN 10216-1	P275T1
EN 10217-1	P275T2, P355N
Fine grained steels	
EN 10025 part 3	S275, S355, S420, S460
EN 10025 part 4	S275, S355, S420, S460
EN 10025 part 6	S460

CALCULATION DATA

Sizes Diam. x length (mm)	Current range (A)	Current type	Arc time	Energy	Dep. rate	Weight/ 1000 pcs (kg)	Electrodes/ kg weldmetal B	kg electrodes/ kg weldmetal 1/N
			- per electrode at max. current - (S)*	E(kJ)	H(kg/h)			
2.5x350	60-95	DC+	50	106	0.82	19.2	90	1.71
3.2x450	80-145	DC+	68	256	1.2	40.1	43	1.73
4.0x450	120-190	DC+	82	436	1.7	63.6	26	1.65
5.0x450	175-230							

*Stub end 35mm

WELDING PARAMETERS, OPTIMUM FILL PASSES

Diameter (mm)	Welding positions					
	PA/1G	PB/2F	PC/2G	PF/3Gup	PE/4G	PH/5Gup
2.5	75A	70A	75A	70A	75A	80A
3.2	100A	110A	100A	100A	100A	110A
4.0	150A	140A	130A	125A	125A	120A

CLASSIFICATION

AWS A5.5	E 8018-G-H4R	A-Nr	10
ISO 2560-A	E 50 6 Mn1Ni B 3 2 H5	F-Nr	4
		9606 FM	2

GENERAL DESCRIPTION

The basic all position offshore electrode with max. 1% Ni
 Excellent mechanical properties (impact down to -60°C)
 Good CTOD at -10°C
 Extremely low hydrogen content
 110 - 120% recovery
 Weldable on AC and DC
 Vacuum sealed Sahara ReadyPack[®]: HDM<3 ml/100g

WELDING POSITIONS (ISO/ASME)



CURRENT TYPE

AC / DC +/-

CHEMICAL COMPOSITION (W%), TYPICAL, ALL WELD METAL

C	Mn	Si	P	S	Ni	HDM
0.05	1.5	0.5	0.010	0.005	0.95	2 ml/100 g

MECHANICAL PROPERTIES, TYPICAL, ALL WELD METAL

Condition	0.2% Proof strength (N/mm ²)	Tensile strength (N/mm ²)	Elongation (%)	Impact ISO-V(J)	
				-40°C	-60°C
Required: AWS A5.5	min. 460	min. 550	min. 19	not required	
ISO 2560-A	min. 500	560-720	min. 18		min. 47
Typical values	550	640	24	140	80
SR:580°C/15h	460	550	24	150	90

CTOD value at -10°C > 0.25 mm

PACKAGING AND AVAILABLE SIZES

SRP	Diameter (mm)	2.5	3.2	3.2	4.0	4.0	5.0
	Length (mm)	350	350	450	350	450	450
	Pieces / unit	70	50	50	28	28	23
	Net weight/unit (kg)	1.4	1.9	2.4	1.5	2.0	2.5

Identification Imprint: 8018-G / KRYO 1P Tip Color: purple

Kryo[®] 1P: rev. C-EN26-01/02/16

Kryo[®] 1P

SMAW

EXAMPLES OF MATERIALS TO BE WELDED

Steel grades/Code	Type
General structural steels	
EN 10025	S275, S355
Ship plates	
ASTM A 131	Grade A, B, D, AH32 to EH40
Cast steels	
EN 10213-2	GP240R
Pipe material	
EN 10208-1	L290 GA, L360 GA
EN 10208-2	L290, L360, L415, L445
API 5LX	X42, X46, X52, X60, X65, X70
EN 10216-1	P275T1
EN 10217-1	P275T2, P355N
Fine grained steels	
EN 10025 part 3	S275, S355, S420, S460
EN 10025 part 4	S275, S355, S420, S460
EN 10025 part 6	S460

CALCULATION DATA

Sizes		Current type	Arc time - per electrode at max. current - [S]*	Energy E(kJ)	Dep. rate H(kg/h)	Weight/ 1000 pcs (kg)	Electrodes/ kg weldmetal B	kg electrodes/ kg weldmetal 1/N
Diam. x length (mm)	Current range (A)							
2.5x350	55-85	DC+	59	85	0.72	19.3	86	1.65
3.2x350	80-145	DC+	66	220	1.2	37.7	48	1.79
3.2x450	80-145	DC+	78	259	1.3	48.7	35	1.72
4.0x350	120-185	DC+	77	355	1.6	54.1	29	1.59
4.0x450	120-185	DC+	90	450	1.8	68.4	23	1.56
5.0x450	180-270	DC+	104	784	2.4	105.2	15	1.53

*Stub end 35mm

WELDING PARAMETERS, OPTIMUM FILL PASSES

Diameter (mm)	Welding positions					
	PA/1G	PB/2F	PC/2G	PF/3Gup	PE/4G	PH/5Gup
2.5	80A	80A	80A	80A	80A	80A
3.2	140A	120A	145A	120A	120A	120A
4.0	150A	140A	150A	140A	135A	140A
5.0	220A	210A	210A	170A		

REMARKS / APPLICATION ADVICE

Redry electrodes 2-4h 350 ±25°C after removal from cardboard boxes

Kryo® 1-145

EMR
SAHARA®

SMAW

CLASSIFICATION

AWS A5.5	E8018-G-H4R	A-Nr	10
ISO 2560-A	E 50 6 Mn1Ni B 5 3 H5	F-Nr	4
		9606 FM	2

GENERAL DESCRIPTION

Basic electrode with max. 1%Ni to meet NACE MR0175 standard
 Extremely low hydrogen content: HDM< 2 ml/100g
 Up to 145% recovery, easy slag release, weldable on AC and DC
 Filling horizontal V- and X-grooves
 Excellent X-ray quality
 Only available in vacuum sealed Sahara ReadyPack®(SRP)

WELDING POSITIONS (ISO/ASME)



PA/1G



PB/2F



PC/2G

CURRENT TYPE

AC / DC +/-

APPROVALS

DNV

5Y46H5

CHEMICAL COMPOSITION (W%), TYPICAL, ALL WELD METAL

C	Mn	Si	P	S	Ni	HDM
0.06	1.5	0.5	0.010	0.010	0.9	2 ml/100 g

MECHANICAL PROPERTIES, TYPICAL, ALL WELD METAL

Condition	0.2% Proof strength [N/mm²]	Tensile strength [N/mm²]	Elongation [%]	Impact ISO-V(J) -60°C
Required: AWS A5.5	460	550	19	
ISO 2560-A	500	560-720	18	min. 47
Typical values AW	570	630	23	90

PACKAGING AND AVAILABLE SIZES

	Diameter (mm)	3.2	4.0	5.0
	Length (mm)	450	450	450
SRP	Pieces / unit	48	25	21
	Net weight/unit (kg)	2.5	2.0	2.6

Identification Imprint: 8018-G / KRYO 1-145 Tip Color: Orange

Kryo® 1-145; rev. C-EN01-12/05/16

All information in this data sheet is accurate to the best of our knowledge at the time of printing. Please refer to www.lincolnelectric.eu for any updated information. Fumes: Safety Data Sheets (SDS) are available on our website.

Kryo[®] 1-145

SMAW

EXAMPLES OF MATERIALS TO BE WELDED

Steel grades/Code Type

General structural steels

EN 10025 S275, S355

Ship plates

ASTM A 131 Grade A, B, D, E, AH32 up to and including EH40

Cast steels

EN 10213-2 GP 240 GH, GP 280 GH

Pipe material

EN 10216-1 P195 TR1 / TR2, P 235 TR1 / TR2, P265 TR1 / TR2

EN 10216-2 P195 GH, P235 GH, P265 GH

EN 10216-3 P275 NL1 / NL2, P355 N / NH / NL1 / NL2, P 460 N / NH / NL1 / NL2

EN 10208-1 L210 GA, L235 GA, L245 GA, L290 GA, L360 GA

EN 10208-2 L245 MB / NB, L290 MB / NB, L360 MB / NB / QB, L415 MB / NB / QB, L450 MB / QB

API 5L X42, X46, X52, X56, X60, X65, X70

Boiler & pressure vessel steel

EN 10028-2 P235 GH, P265 GH, P295 GH, P355GH

Fine grained steels

EN 10025 part 3 S275 N / NL, S355 N / NL, S420 N / NL, S460 N / NL

EN 10025 part 4 S275 M / ML, S355 M / ML, S420 M / ML, S460 M / ML

EN 10025 part 6 S460 / S460 Q/QL/QL1, S500 Q/QL/QL1 0, S500

Others

Steel grades with equivalent requirements as per above classified per ASTM, JIS etc

CALCULATION DATA

Sizes Diam. x length (mm)	Current range (A)	Current type	Arc time	Energy	Dep. rate	Weight/ 1000 pcs (kg)	Electrodes/ kg weldmetal B	kg electrodes/ kg weldmetal 1/N
			- per electrode at max. current - (S)*	E(kJ)	H(kg/h)			
3.2x450	90-150	DC+	82	271	1,6	54,4	27	1,47
4.0x450	150-190	DC+	95	433	2,2	82,2	18	1,48
5.0x450	180-270	DC+	98	688	3,3	127,4	12	1,53

*Stub end 45mm

WELDING PARAMETERS, OPTIMUM FILL PASSES

Diameter (mm)	Welding positions		
	PA/1G	PB/2F	PC/2G
3.2	130 A	130 A	130 A
4.0	170 A	160 A	160 A
5.0	235 A	225 A	225 A

Kryo[®] 1-180

EMR
SAHARA[®]

SMAW

CLASSIFICATION

AWS A5.5	E 8018-G-H4R	A-Nr	10
ISO 2560-A	E 50 5 1Ni B 7 3 H5	F-Nr	4
		9606 FM	2

GENERAL DESCRIPTION

Basic electrode with max. 1%Ni
 Extremely low hydrogen content
 Approx. 175% recovery, easy slag release, weldable on AC and DC
 Filling horizontal V- and X-grooves
 Excellent X-ray quality
 Also available in vacuum sealed Sahara ReadyPack[®] (SRP): HDM<3 ml/100g

WELDING POSITIONS (ISO/ASME)



CURRENT TYPE

AC / DC + / -

APPROVALS

DNV	LR
4Y4H5	4YH5

CHEMICAL COMPOSITION (W%), TYPICAL, ALL WELD METAL

C	Mn	Si	P	S	Ni	HDM
0.07	1.2	0.3	0.02	0.0010	0.9	2 ml/100 g

MECHANICAL PROPERTIES, TYPICAL, ALL WELD METAL

Condition	0.2% Proof strength [N/mm ²]	Tensile strength [N/mm ²]	Elongation [%]	Impact ISO-V(J)	
				-40°C	-50°C
Required: AWS A5.5	min. 460	min. 550	min. 19	not required	
ISO 2560-A	min. 500	560-720	min. 18		min. 47
Typical values	AW	550	640	26	90
SR:600°C/4h	540	620	24	100	85

CTOD value at -10°C > 0.25 mm

PACKAGING AND AVAILABLE SIZES

SRP	Diameter (mm)	3.2	4.0	5.0
	Length (mm)	450	450	450
Pieces / unit	Net weight/unit (kg)	27	23	19
		2.0	2.4	2.8

Identification Imprint: 8018-G / KRYO 1-180 Tip Color: pink

Kryo[®] 1-180: rev. C-EN25-01/02/16

All information in this data sheet is accurate to the best of our knowledge at the time of printing. Please refer to www.lincolnelectric.eu for any updated information. Fumes: Safety Data Sheets (SDS) are available on our website.

Kryo[®] 1-180

SMAW

EXAMPLES OF MATERIALS TO BE WELDED

Steel grades/Code	Type
General structural steels	
EN 10025	S275, S355
Ship plates	
ASTM A 131	Grade A, B, D, AH32 to EH40
Cast steels	
EN 10213-2	GP240R
Pipe material	
EN 10208-1	L290 GA, L360 GA
EN 10208-2	L290, L360, L415, L445
API 5LX	X42, X46, X52, X60, X65, X70
EN 10216-1	P275T1
EN 10217-1	P275T2, P355N
Fine grained steels	
EN 10025 part 3	S275, S355, S420, S460
EN 10025 part 4	S275, S355, S420, S460
EN 10025 part 6	S460, S500

CALCULATION DATA

Sizes Diam. x length (mm)	Current range (A)	Current type	Arc time	Energy	Dep. rate	Weight/ 1000 pcs (kg)	Electrodes/ kg weldmetal B	kg electrodes/ kg weldmetal 1/N
			- per electrode at max. current - (S)*	- per electrode at max. current - E(kJ)	- per electrode at max. current - H(kg/h)			
3.2x450	130-160							
4.0x450	170-240	AC	73	537	3.5	102.0	14	1.43
5.0x450	250-300	AC	78	772	5.0	156.7	9	1.45

*Stub end 35mm

WELDING PARAMETERS, OPTIMUM FILL PASSES

Diameter (mm)	Welding positions		
	PA/1G	PB/2F	PC/2G
4.0	230A	190A	190A
5.0	300A	230A	230A

REMARKS / APPLICATION ADVICE

Redry electrodes 2-4h 350 ±25°C after removal from cardboard boxes

Kryo[®] 2

EMR
SAHARA[®]

SMAW

CLASSIFICATION

AWS A5.5	E9018-G-H4R	A-Nr	10
ISO 18275-A	E 55 6 Z B 3 2 H5	F-Nr	4
		9606 FM	2

GENERAL DESCRIPTION

Basic all position offshore electrode for high strength steels
 110 - 120% recovery
 Extremely low hydrogen content
 Excellent impact toughness down to -60°C
 Good CTOD at -15°C
 Also available in vacuum sealed Sahara ReadyPack[®](SRP): HDM<3 ml/100g

WELDING POSITIONS (ISO/ASME)

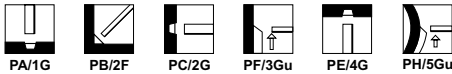

CURRENT TYPE

AC / DC +/-

CHEMICAL COMPOSITION (W%), TYPICAL, ALL WELD METAL

C	Mn	Si	P	S	Ni	HDM
0.05	1.6	0.3	0.015	0.01	1.5	2 ml/100 g

MECHANICAL PROPERTIES, TYPICAL, ALL WELD METAL

Condition	0.2% Proof strength [N/mm ²]	Tensile strength [N/mm ²]	Elongation [%]	Impact ISO-V(J)		
				-40°C	-50°C	-60°C
Required: AWS A5.5	min. 530	min. 620	min. 17	not required		
ISO 18275-A	min. 550	610-780	min. 18			min. 47
Typical values						
AW	570	650	22	140	110	60
SR:620°C/1h	530	620	22			

CTOD value at -10°C > 0.25 mm

PACKAGING AND AVAILABLE SIZES

	Diameter (mm)	2.5	3.2	4.0
		Length (mm)	350	450
SRP	Pieces / unit	70	50	28
	Net weight/unit (kg)	1.4	2.4	2.0

Identification Imprint: 9018-G / KRYO 2 Tip Color: green

Kryo[®] 2: rev. C-EN27-01/02/16

Kryo[®] 2

SMAW

EXAMPLES OF MATERIALS TO BE WELDED

Steel grades/Code	Type
General structural steels	
EN 10025	S355
Cast steels	
EN 10213-2	GP240R
Pipe material	
EN 10208-1	L290 GA, L360 GA
EN 10208-2	L290, L360, L415, L445, L480
API 5LX	X42, X46, X52, X60, X65, X70
EN 10216-1	P275T1
EN 10217-1	P275T2, P355N
Fine grained steels	
EN 10025 part 3	S275, S355, S420, S460
EN 10025 part 4	S275, S355, S420, S460
EN 10025 part 6	S460, S500
Low temperature steels	
EN 10028-4	11MnNi5-3, 13 MnNi6-3, 15NiMn 6
EN 10222-3	13MnNi6-3, 15NiMn 6

CALCULATION DATA

Sizes		Current range (A)	Current type	Arc time (S)*	Energy (kJ)	Dep. rate H(kg/h)	Weight/ 1000 pcs (kg)	Electrodes/ kg weldmetal B	kg electrodes/ kg weldmetal 1/N
Diam. x length (mm)	Current range (A)								
2.5x350	55-85	DC+	59	85	0.72	19.4	86	1.65	
3.2x450	80-140	DC+	80	268	1.2	46.8	36	1.70	
4.0x450	120-170	DC+	89	445	1.8	70.0	22	1.52	

*Stub end 35mm

WELDING PARAMETERS, OPTIMUM FILL PASSES

Diameter (mm)	Welding positions					
	PA/1G	PB/2F	PC/2G	PF/3Gup	PE/4G	PH/5Gup
2.5	80A	80A	80A	85A	80A	80A
3.2	140A	120A	145A	120A	120A	120A
4.0	150A	140A	150A	140A	135A	140A

REMARKS / APPLICATION ADVICE

Redry electrodes 2-4h 350 ±25°C after removal from cardboard boxes

CLASSIFICATION

AWS A5.5	E 8018-C1-H4	A-Nr	10
ISO 2560-A	E 46 8 3Ni B 32 H5*	F-Nr	4
* Nearest equivalent		9606 FM	1

GENERAL DESCRIPTION

The basic all position offshore electrode with approx. 2.5% Ni
 115 - 120% recovery
 Excellent impact toughness down to -80°C
 Good CTOD at -10°C
 Extremely low hydrogen content
 Also available in vacuum sealed Sahara ReadyPack[®] (SRP): HDM < 3 ml/100g

WELDING POSITIONS (ISO/ASME)

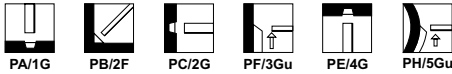

CURRENT TYPE

AC / DC +/-

APPROVALS

ABS	BV	DNV	LR	GL	RINA	TÜV
+	UP	5YH10	5Y40H	6Y42H10	5YH5	+

CHEMICAL COMPOSITION (W%), TYPICAL, ALL WELD METAL

C	Mn	Si	P	S	Ni	HDM
0.05	0.7	0.3	0.015	0.01	2.5	2 ml/100 g

MECHANICAL PROPERTIES, TYPICAL, ALL WELD METAL

Condition	0.2% Proof strength [N/mm ²]	Tensile strength [N/mm ²]	Elongation [%]	Impact ISO-V(J)	
				-60°C	-80°C
Required: AWS A5.5 ISO 2560-A Typical values	SR ¹⁾ min. 460 min. 460	min. 550 530-680	min. 19 min. 20	min. 27	
	AW SR:610°C/2h 500	520 600 590	26 4.4 29	120 90	60

CTOD value at -10°C > 0.25 mm

Stress relieved: SR¹⁾ = 605±14°C/1h

PACKAGING AND AVAILABLE SIZES

	Diameter (mm)	2.5	3.2	3.2	4.0	4.0	5.0
	Length (mm)	350	350	450	350	450	450
Carton + PE foil	Pieces / unit	135	120	-	85	85	55
	Net weight/unit (kg)	2.7	4.2	-	4.4	5.9	5.7
SRP	Pieces / unit	70	50	50	28	28	23
	Net weight/unit (kg)	1.4	1.9	2.4	1.5	2.0	2.5

Identification Imprint: 8018-C1 / KRYO 3 Tip Color: silver

Kryo[®] 3: rev. C-EN26-01/02/16

Kryo[®] 3

SMAW

EXAMPLES OF MATERIALS TO BE WELDED

Steel grades/Code	Type
General structural steels	
EN 10025	S355
Pipe material	
EN 10208-2	L360, L415, L445
API 5LX	X52, X56, X60, X65
Fine grained steels	
EN 10025 part 3	S355, S420, S460
EN 10025 part 4	S355, S420, S460
Low temperature steels	
EN 10028-4	11MnNi5-3, 13MnNi6-3, 15NiMn6 (12Ni4G1, G2)
EN 10222-3	13MnNi6-3, 15NiMn6

CALCULATION DATA

Sizes		Current type	Arc time - per electrode at max. current - [S]*	Energy E(kJ)	Dep. rate H(kg/h)	Weight/ 1000 pcs (kg)	Electrodes/ kg weldmetal B	kg electrodes/ kg weldmetal 1/N
Diam. x length (mm)	Current range (A)							
2.5x350	55-80	DC+	57	103	0.72	19.5	88	1.71
3.2x350	80-140	DC+	65	218	1.3	37.4	44	1.64
3.2x450	80-140	DC+	79	263	1.4	48.5	33	1.59
4.0x350	120-170	DC+	74	344	1.6	52.7	30	1.57
4.0x450	120-170	DC+	100	463	1.7	69.8	21	1.45
5.0x450	180-240	DC+	103	723	2.5	104.8	14	1.48

*Stub end 35mm

WELDING PARAMETERS, OPTIMUM FILL PASSES

Diameter (mm)	Welding positions					
	PA/1G	PB/2F	PC/2G	PF/3Gup	PE/4G	PH/5Gup
2.5	80A	80A	80A	85A	80A	80A
3.2	140A	120A	145A	120A	120A	120A
4.0	150A	140A	150A	140A	135A	140A
5.0	220A	210A	210A	170A		

REMARKS / APPLICATION ADVICE

Deviations: chemical composition:
 Ni = 2.25 - 2.75% ISO: Ni = 2.6 - 3.8%

CLASSIFICATION

AWS A5.5	E7016-C2L-H4R	A-Nr	10
ISO 2560-A	E 38 8 3Ni B 3 2 H5	F-Nr	4
		9606 FM	1

GENERAL DESCRIPTION

The basic all position offshore electrode with approx. 3.5% Ni
 Excellent impact toughness down to -80°C in as welded condition and -100°C after PWHT
 Extremely low hydrogen content
 Only available in vacuum sealed Sahara ReadyPack® (SRP)

WELDING POSITIONS (ISO/ASME)



CURRENT TYPE

AC / DC +/-

CHEMICAL COMPOSITION (W%), TYPICAL, ALL WELD METAL

C	Mn	Si	P	S	Ni	HDM
0.03	0.6	0.4	0.01	0.005	3.6	2 ml/100 g

MECHANICAL PROPERTIES, TYPICAL, ALL WELD METAL

	Condition	Yield strength (N/mm ²)	Tensile strength (N/mm ²)	Elongation (%)	Impact ISO-V(J)	
					-80°C	-101°C
Required: AWS A5.5	PWHT ¹⁾	min. 390	min. 480	min. 25		min. 27
ISO 2560-A	AW	min. 380	470-600	min. 20	47	
Typical values	AW	490	570	30	90	
	PWHT ¹⁾	420	510	30	120	90

¹⁾605±14°C/1h

PACKAGING AND AVAILABLE SIZES

	Diameter (mm)	2.5	3.2
	Length (mm)	350	350
SRP	Pieces / unit	70	58
	Net weight/unit (kg)	1.4	1.8

Identification Imprint: 7016-C2 / KRYO 4 Tip Color: silver

Kryo® 4; rev. C-EN27-01/02/16

Kryo[®] 4

SMAW

EXAMPLES OF MATERIALS TO BE WELDED

Steel grades/Code	Type
General structural steels	
EN 10025-2	S355
Pipe material	
EN 10208-2	L360, L415
API 5LX	X52, X56, X60
Fine grained steels	
EN 10025 part 3	S355, S420
EN 10025 part 4	S355, S420
Low temperature steels	
EN 10028-4	11MnNi5-3, 13MnNi6-3, 15NiMn6 (12Ni4G1, G2)
EN 10222-3	13MnNi6-3, 15NiMn6
ASTM A203	Grade A, B
ASTM A333	Grade 3
ASTM A334	Grade 3
ASTM A350	Grade LF3, CL1 & 2
ASTM A420	Grade WPC3

CALCULATION DATA

Sizes Diam. x length (mm)	Current range (A)	Current type	Arc time	Energy	Dep. rate	Weight/ 1000 pcs (kg)	Electrodes/ kg weldmetal B	kg electrodes/ kg weldmetal 1/N
			- per electrode at max. current - (S)*	E(kJ)	H(kg/h)			
2.5x350	60-90	DC+	60	85	0.75	14.7	100	1.43
3.2x350	80-140	DC+	72	207	1.1	30.8	48	1.45

*Stub end 35mm

WELDING PARAMETERS, OPTIMUM FILL PASSES

Diameter (mm)	Welding positions					
	PA/1G	PB/2F	PC/2G	PF/3Gup	PE/4G	PH/5Gup
2.5	75A	70A	75A	70A	75A	80A
3.2	110A	120A	110A	100A	100A	100A

CLASSIFICATION

AWS A5.5	E7018-A1-H4R	A-Nr	2
ISO 3580-A	E Mo B 3 2 H5	F-Nr	4
		9606 FM	1/3

GENERAL DESCRIPTION

Basic very low hydrogen all position electrode (HDM< 5 ml/100g)
 For welding creep resisting and Fine grained steels
 Service temperature from -40 up to 500°C
 DC-welding preferred
 115 - 120% recovery
 Also available in vacuum sealed Sahara ReadyPack[®] (SRP)

WELDING POSITIONS (ISO/ASME)

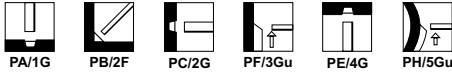

CURRENT TYPE

AC / DC +/-

APPROVALS

DB	DNV	TÜV
+	0,3 Mo	+

CHEMICAL COMPOSITION (W%), TYPICAL, ALL WELD METAL

C	Mn	Si	P	S	Mo	HDM
0.05	0.8	0.6	0.020	0.010	0.55	2 ml/100 g

MECHANICAL PROPERTIES, TYPICAL, ALL WELD METAL

	Condition	0.2% Proof strength [N/mm ²]	Tensile strength [N/mm ²]	Elongation [%]	Impact ISO-V(J)	
					+20°C	-20°C
Required: AWS A5.5	SR ¹	min. 390	min. 490	min. 25	not required	
ISO 3580-A	SR ²	min. 355	min. 510	min. 22	min. 47	
Typical values	SR ³	560	620	25	140	50
	AW	550	610	25	160	70

Stress relieved: SR¹ = 620±14°C/1h, SR² = 570-620°C/1h, SR³ = 620°C/1h

PACKAGING AND AVAILABLE SIZES

	Diameter (mm) Length (mm)	2.5	3.2	4.0	5.0
			350	350	350
Carton + PE foil	Pieces / unit	110	120	85	55
	Net weight/unit (kg)	2.5	4.5	4.7	6.0
SRP	Pieces / unit	67	50	28	23
	Net weight/unit (kg)	1.4	2.0	1.5	2.6

Identification Imprint: 7018-A1 / SL 12 G Tip Color: blue

SL[®] 12G: rev. C-EN26-12/05/16

All information in this data sheet is accurate to the best of our knowledge at the time of printing. Please refer to www.lincolnelectric.eu for any updated information. Fumes: Safety Data Sheets (SDS) are available on our website.

SL[®] 12G

SMAW

EXAMPLES OF MATERIALS TO BE WELDED

Steel grades/Standard	Type
Creep resistant steels	
EN 10028-2	P295GH, P355GH, 16Mo3 & similar alloys
EN 10222-2	17Mo3, 14Mo6 & similar alloys
ASTM A335	Grade P1
ASTM A209	Grade T1
ASTM A250	Grade T1
ASTM A336	Grade F1
ASTM A204	Grade A, B, C
ASTM A217	Grade WC1
ASTM A352	Grade LC1
Fine grained steels	
EN 10025 part 3	S275, S355, S420
EN 10025 part 4	S275, S355, S420

CREEP DATA

Test temperature °C	400	450	500	550
Yield strength Rp-0,2% [N/mm ²]	420	380	330	
Creep strength Rm/1000 [N/mm ²]		360	300	[200]
Creep strength Rm/10.000 [N/mm ²]		320	180	[80]
Creep resistance Rp1%/10.000 [N/mm ²]		230	150	[65]

CALCULATION DATA

Sizes		Current type	Arc time - per electrode at max. current - [S]*	Energy E[kJ]	Dep. rate H[kg/h]	Weight/ 1000 pcs [kg]	Electrodes/ kg weldmetal B	kg electrodes/ kg weldmetal 1/N
Diam. x length [mm]	Current range [A]							
2.5x350	60-90	DC+	65	118	0.7	22.8	84	1.92
3.2x350	80-130	DC+	69	230	1.3	379	42	1.59
4.0x350	120-180	DC+	81	373	1.6	54.8	28	1.56
5.0x450	160-240	DC+	106	799	2.4	1074	14	1.52

*Stub end 35mm

WELDING PARAMETERS, OPTIMUM FILL PASSES

Diameter [mm]	Welding positions					
	PA/1G	PB/2F	PC/2G	PF/3Gup	PE/4G	PH/5Gup
2.5	80A	85A	80A	85A	80A	80A
3.2	130A	120A	130A	120A	120A	120A
4.0	150A	145A	140A	140A	140A	140A
5.0	225A	225A	210A			

REMARKS / APPLICATION ADVICE

Recommended tempering heat treatment range:580 - 630°C (time depends on material thickness)
Redry electrodes 2-4h 350 ±25°C after removal from cardboard boxes

CLASSIFICATION

AWS A5.5	E8018-B2-H4	A-Nr	3
ISO 3580-A	E CrMo1 B 3 2 H5	F-Nr	4
		9606 FM	3

GENERAL DESCRIPTION

Basic very low hydrogen all position electrode (HDM< 5 ml/100g)

For welding creep and hydrogen resistant CrMo-steels

Maximum service temperature 550°C

DC-welding preferred

115 - 120% recovery

Also available in vacuum sealed Sahara ReadyPack[®](SRP)

WELDING POSITIONS (ISO/ASME)



PA/1G



PB/2F



PC/2G



PF/3Gu



PE/4G



PH/5Gu

CURRENT TYPE

AC / DC +/-

APPROVALS

BV	DNV	RINA	TÜV
C1M	1Cr0,5Mo	C1M	+

CHEMICAL COMPOSITION (W%), TYPICAL, ALL WELD METAL

C	Mn	Si	P	S	Cr	Mo	HDM
0.06	0.75	0.6	0.015	0.010	1.1	0.5	3 ml/100 g

MECHANICAL PROPERTIES, TYPICAL, ALL WELD METAL

Condition	0.2% Proof strength (N/mm ²)	Tensile strength (N/mm ²)	Elongation (%)	Impact ISO-V(J)	
				+20°C	-20°C
Required: AWS A5.5	SR ¹	min. 460	min. 550	min. 19	not required
ISO 3580-A	SR ²	min. 355	min. 510	min. 20	min. 47
Typical values	SR ³	570	640	24	180
					100

Stress relieved: SR¹ = 690±14°C/1h, SR² = 660-700°C/1h, SR³ = 700°C/1h

PACKAGING AND AVAILABLE SIZES

	Diameter (mm)	2.5	3.2	4.0	5.0
		Length (mm)	350	350	350
Carton + PE foil	Pieces / unit	120	120	85	55
	Net weight/unit (kg)	2.6	4.6	4.7	6.1
SRP	Pieces / unit	67	50	28	-
	Net weight/unit (kg)	1.4	2.0	1.5	-

Identification Imprint: 8018-B2 / SL 19 G Tip Color: red

SL[®] 19G: rev. C-EN25-12/05/16

SL[®] 19G

SMAW

EXAMPLES OF MATERIALS TO BE WELDED

Steel grades/Standard	Type
Creep resistant steels	
EN 10028-2	13CrMo4-5 & similar alloys
EN 10083-1	25CrMo4 & similar alloys
EN 10222-2	14CrMo4-5 & similar alloys
ASTM A387	Grade 11 & 12
ASTM A182	Grade F1 & F12
ASTM A217	Grade WC6 & WC11
ASTM A234	Grade WP11 & WP12
ASTM A199	Grade T11
ASTM A200	Grade T11
ASTM A213	Grade T11 & T12
ASTM A335	Grade P11 & P12
Tool steel	
DIN 17210	16MnCr5 & similar alloys

CREEP DATA

Test temperature °C	400	450	500	550	600
Yield strength Rp-0.2% (N/mm ²)	460	440	430		
Creep strength Rm/1000 (N/mm ²)			300	140	(80)
Creep strength Rm/10.000 (N/mm ²)		350	240	110	(50)
Creep resistance Rp1%/10.000 (N/mm ²)		250	170	80	(35)

CALCULATION DATA

Diam. x length (mm)	Current range (A)	Current type	Arc time	Energy	Dep. rate	Weight/ 1000 pcs (kg)	Electrodes/ kg weldmetal B	kg electrodes/ kg weldmetal 1/N
			- per electrode at max. current - (S)*	E(kJ)	H(kg/h)			
2.5x350	60-90	DC+	63	114	0.71	21.0	80	1.67
3.2x350	80-130	DC+	68	227	1.3	37.9	41	1.56
4.0x350	120-180	DC+	79	367	1.6	54.9	29	1.59
5.0x450	160-240	DC+	103	777	2.5	106.9	14	1.52

*Stub end 35mm

WELDING PARAMETERS, OPTIMUM FILL PASSES

Diameter (mm)	Welding positions					
	PA/1G	PB/2F	PC/2G	PF/3Gup	PE/4G	PH/5Gup
2.5	80A	85A	80A	85A	80A	80A
3.2	130A	120A	130A	120A	120A	120A
4.0	150A	145A	140A	140A	140A	140A
5.0	225A	225A	210A			

REMARKS / APPLICATION ADVICE

Recommended preheat temperature: 200 - 250°C
 Recommended tempering heat treatment range: 660 - 700°C (time depends on material thickness)
 Redry electrodes 2-4h 350 ±25°C after removal from cardboard boxes

SL[®] 20G

EMR
SAHARA[®]

SMAW

CLASSIFICATION

AWS A5.5	E9018-B3-H4	A-Nr	4
ISO 3580-A	E CrMo2 B 3 2 H5	F-Nr	4
		9606 FM	3

GENERAL DESCRIPTION

Basic very low hydrogen all position electrode (HDM<5 ml/100g)

For welding creep and hydrogen resistant CrMo-steels

Maximum service temperature 600°C

DC-welding preferred

115 - 120% recovery

Also available in vacuum sealed Sahara ReadyPack[®] (SRP)

WELDING POSITIONS (ISO/ASME)



PA/1G



PB/2F



PC/2G



PF/3Gu



PE/4G



PH/5Gu

CURRENT TYPE

AC / DC +/-

APPROVALS

RINA TÜV

C2M1 +

CHEMICAL COMPOSITION (W%), TYPICAL, ALL WELD METAL

C	Mn	Si	P	S	Cr	Mo	HDM
0.06	0.8	0.6	0.015	0.010	2.3	1.0	3 ml/100 g

MECHANICAL PROPERTIES, TYPICAL, ALL WELD METAL

	Condition	0.2% Proof strength [N/mm ²]	Tensile strength [N/mm ²]	Elongation [%]	Impact ISO-V(J)	
					+20°C	-10°C
Required: AWS A5.5	SR ¹	min. 530	min. 620	min. 17	not required	
ISO 3580-A	SR ²	min. 400	min. 500	min. 18	min. 47	
Typical values	SR ³	530	650	22	150	90

Stress relieved: SR¹ = 690±14°C/1h, SR² = 690-750°C/1h, SR³ = 695°C/1h

PACKAGING AND AVAILABLE SIZES

	Diameter (mm)			
	2.5	3.2	4.0	
Carton + PE foil	Length (mm)			
	350	350	350	
SRP	Pieces / unit	110	120	85
	Net weight/unit (kg)	2.6	4.7	4.8
SRP	Pieces / unit	67	50	28
	Net weight/unit (kg)	1.4	2.0	1.5

Identification Imprint: 9018-B3 / SL 20 G Tip Color: white

SL[®] 20G: rev. C-ENZ-12/05/16

SL[®] 20G

SMAW

EXAMPLES OF MATERIALS TO BE WELDED

Steel grades/Standard	Type
Creep resistant steels	
EN 10028-2	10CrMo9-10 & similar alloys
EN 10222-2	12CrMo9-10 & similar alloys
ASTM A387	Grade 21 & 22
ASTM A182	Grade F22
ASTM A217	Grade WC9
ASTM A234	Grade WP22
ASTM A199/A200	Grade T21 & T22
ASTM A213	Grade T22
ASTM A335	Grade P22

CREEP DATA

Test temperature °C	400	450	500	550	600
Yield strength Rp-0,2% [N/mm ²]	480	460	430	160	[100]
Creep strength Rm/1000 [N/mm ²]			240	210	[60]
Creep strength Rm/10.000 [N/mm ²]			160	85	[45]

CALCULATION DATA

Sizes Diam. x length [mm]	Current range [A]	Current type	Arc time	Energy	Dep. rate	Weight/ 1000 pcs [kg]	Electrodes/ kg weldmetal B	kg electrodes/ kg weldmetal 1/N
			- per electrode at max. current - [S]*	E[kJ]	H[kg/h]			
2.5x350	60-90	DC+	63	114	0.72	21.0	79	1.67
3.2x350	80-130	DC+	70	233	1.3	37.6	40	1.49
4.0x350	120-180	DC+	75	348	1.7	56.7	28	1.56

*Stub end 35mm

WELDING PARAMETERS, OPTIMUM FILL PASSES

Diameter [mm]	Welding positions					
	PA/1G	PB/2F	PC/2G	PF/3Gup	PE/4G	PH/5Gup
2.5	80A	85A	80A	85A	80A	80A
3.2	130A	120A	130A	120A	120A	120A
4.0	150A	145A	140A	140A	140A	140A

REMARKS / APPLICATION ADVICE

Recommended preheat temperature:200 - 300°C
 Recommended tempering heat treatment range:690 - 750°C (time depends on material thickness)
 Redry electrodes 2-4h 350 ±25°C after removal from cardboard boxes

SL® 22G

EMR SAHARA®

SMAW

CLASSIFICATION

AWS A5.5	E8018-B1-H4	A-Nr	3
ISO 3580-A	E Z B 3 2 H5	F-Nr	4
		9606 FM	3

GENERAL DESCRIPTION

Basic very low hydrogen all position electrode (HDM < 5 ml/100g)
 For welding creep resistant CrMoV-steels
 Maximum service temperature 550°C
 DC-welding preferred
 115 - 120% recovery
 Only available in vacuum sealed Sahara ReadyPack® (SRP)

WELDING POSITIONS (ISO/ASME)



PA/1G



PB/2F



PC/2G



PF/3Gu



PE/4G



PH/5Gu

CURRENT TYPE

AC / DC +/-

APPROVALS

TÜV

+

CHEMICAL COMPOSITION (W%), TYPICAL, ALL WELD METAL

C	Mn	Si	P	S	Cr	Mo	HDM
0.06	0.8	0.6	0.020	0.010	0.5	0.5	3 ml/100 g

MECHANICAL PROPERTIES, TYPICAL, ALL WELD METAL

Condition	0.2% Proof strength [N/mm ²]	Tensile strength [N/mm ²]	Elongation [%]	Impact ISO-V(J)	
				+20°C	-10°C
Required: AWS A5.5	SR ¹	min. 460	min. 550	min. 19	not required
Typical values	SR ²	570	640	24	180
					110

Stress relieved: SR¹ = 690±14°C/1h, SR² = 1h/730°C

PACKAGING AND AVAILABLE SIZES

	Diameter (mm)	2.5	3.2	4.0	5.0
	Length (mm)	350	350	350	450
SRP	Pieces / unit	67	50	28	23
	Net weight/unit (kg)	1.4	2.0	1.5	2.6

Identification Imprint: 8018-B1 / SL 22 G Tip Color: orange

SL® 22G; rev. C-EN24-01/02/16

All information in this data sheet is accurate to the best of our knowledge at the time of printing. Please refer to www.lincolnelectric.eu for any updated information.
 Fumes: Safety Data Sheets (SDS) are available on our website.

SL[®] 22G

SMAW

EXAMPLES OF MATERIALS TO BE WELDED

Steel grades/Code	Type
Creep resistant steels	
DIN	14MoV6-3
	17MnMoV6-4
	10CrSiMoV7
	24CrMoV5-5

CREEP DATA

Test temperature °C	400	450	500	550	575
Yield strength Rp-0,2% (N/mm ²)	480	470	450		
Creep strength Rm/1000 (N/mm ²)			270	170	150
Creep strength Rm/10.000 (N/mm ²)			250	150	130
Creep resistance Rp1%/10.000 (N/mm ²)			210	130	110

CALCULATION DATA

Sizes		Current type	Arc time - per electrode at max. current - [S]*	Energy E(kJ)	Dep. rate H(kg/h)	Weight/ 1000 pcs (kg)	Electrodes/ kg weldmetal B	kg electrodes/ kg weldmetal 1/N
Diam. x length (mm)	Current range (A)							
2.5x350	60-90	DC+	64	115	0.7	21.0	82	1.69
3.2x350	80-130	DC+	71	238	1.2	37.5	41	1.54
4.0x350	120-180	DC+	76	353	1.6	55.8	30	1.64
5.0x450	160-220	DC+	101	762	2.6	106.6	14	1.49

*Stub end 35mm

WELDING PARAMETERS, OPTIMUM FILL PASSES

Diameter (mm)	Welding positions					
	PA/1G	PB/2F	PC/2G	PF/3Gup	PE/4G	PH/5Gup
2.5	80A	85A	80A	85A	80A	80A
3.2	130A	120A	130A	120A	120A	120A
4.0	150A	145A	140A	140A	140A	140A
5.0	225A	225A	210A			

REMARKS / APPLICATION ADVICE

Recommended preheat temperature:200 - 300°C

Recommended tempering heat treatment range:700 - 730°C (time depends on material thickness)

CLASSIFICATION

AWS A5.5	E8018-B6-H4R	A-Nr	4
ISO 3580-A	E CrMo5 B 3 2 H5	F-Nr	4
		9606 FM	4

GENERAL DESCRIPTION

Basic very low hydrogen all position electrode (HDM< 5 ml/100g)
 For welding creep and hydrogen resistant 5% Cr-0.5% Mo-steels
 Maximum service temperature 550°C
 Developed for the petrochemical industry
 Only available in vacuum sealed Sahara ReadyPack[®](SRP)

WELDING POSITIONS (ISO/ASME)

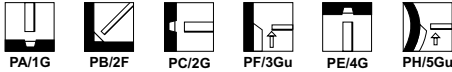

CURRENT TYPE

AC / DC +/-

APPROVALS

TÜV

+

CHEMICAL COMPOSITION (W%), TYPICAL, ALL WELD METAL

C	Mn	Si	P	S	Cr	Mo	HDM
0.07	0.8	0.6	0.020	0.010	5.3	0.6	3 ml/100 g

MECHANICAL PROPERTIES, TYPICAL, ALL WELD METAL

Condition		0.2% Proof strength [N/mm ²]	Tensile strength [N/mm ²]	Elongation [%]	Impact ISO-V(J) +20°C
Required: AWS A5.5	SR ¹⁾	min. 460	min. 550	min. 19	not required
ISO 3580-A	SR ²⁾	min. 400	min. 590	min. 17	min. 47
Typical values	SR ³⁾	580	680	22	110

Stress relieved: SR¹⁾= 740 ±14°C/1h, SR²⁾= 730-760°C/1h, SR³⁾= 750°C/2h

PACKAGING AND AVAILABLE SIZES

	Diameter (mm)	2.5	3.2	4.0
	Length (mm)	350	350	350
SRP	Pieces / unit	67	52	29
	Net weight/unit (kg)	1.4	1.9	1.6

Identification Imprint: 8018-B6 / SL 502 Tip Color: brown

SL[®] 502 rev. C-EN25-01/02/16

SL[®] 502

SMAW

EXAMPLES OF MATERIALS TO BE WELDED

Steel grades/Code	Type
Creep resistant steels	
DIN	
ASTM	A182 F5 A213 T5 A335 P5 A336 F5 A369 FP5 A387 Grade 5

CREEP DATA

Test temperature °C	400	450	500	550	600
Yield strength Rp-0,2% (N/mm ²)	480	440	380		
Creep strength Rm/1000 (N/mm ²)			160	174	(80)
Creep strength Rm/10.000 (N/mm ²)			130	90	(60)
Creep resistance Rp1%/10.000 (N/mm ²)			100	50	(30)

CALCULATION DATA

Sizes		Current type	Arc time - per electrode at max. current - (S)*	Energy E(kJ)	Dep. rate H(kg/h)	Weight/ 1000 pcs (kg)	Electrodes/ kg weldmetal B	kg electrodes/ kg weldmetal 1/N
Diam. x length (mm)	Current range (A)							
2.5x350	60-90	DC+	55	95	0.82	20.8	80	1.67
3.2x350	85-130	DC+	66	237	1.1	35.4	50	1.79
4.0x350	130-180	DC+	76	331	1.5	51.8	32	1.64

*Stub end 35mm

WELDING PARAMETERS, OPTIMUM FILL PASSES

Diameter (mm)	Welding positions					
	PA/1G	PB/2F	PC/2G	PF/3Gup	PE/4G	PH/5Gup
2.5	80A	80A	75A	70A	70A	70A
3.2	130A	130A	125A	120A	120A	120A
4.0	140A	140A	135A	135A	135A	135A

REMARKS / APPLICATION ADVICE

Recommended preheat temperature: 200 - 300°C
 Postweld heat treatment 730 - 760°C (time depends on material thickness)

SL® 9Cr(P91)

EMR SAHARA®

SMAW

CLASSIFICATION

AWS A5.5	E9016-B9-H4	A-Nr	5
ISO 3580-A	E CrMo91 B 3 2 H5	F-Nr	4
		9606 FM	4

GENERAL DESCRIPTION

Basic very low hydrogen all position electrode (HDM<5 ml/100g)
 For welding creep and hydrogen resistant 9% Cr-1% Mo steels
 Maximum service temperature 650°C
 Developed for power plants and the petrochemical industry
 Only available in vacuum sealed Sahara ReadyPack®(SRP)

WELDING POSITIONS (ISO/ASME)



PA/1G



PB/2F



PC/2G



PF/3Gu



PE/4G



PH/5Gu

CURRENT TYPE

AC / DC +/-

APPROVALS

TÜV

+

CHEMICAL COMPOSITION (W%), TYPICAL, ALL WELD METAL

C	Mn	Si	P	S	Cr	Mo	Ni	Nb	V	N	Mn+Ni	HDM
0.09	0.6	0.2	0.01	0.01	9.0	1.0	0.6	0.04	0.2	0.04	1.2	3 ml/100 g

MECHANICAL PROPERTIES, TYPICAL, ALL WELD METAL

Condition	0.2% Proof strength (N/mm ²)	Tensile strength (N/mm ²)	Elongation (%)	Impact ISO-V(J)	
				+20°C	
Required: AWS A5.5	SR ¹	min. 530	min. 620	min. 11	not required
ISO 3580-A	SR ²	min. 415	min. 585	min. 17	min. 47
Typical values	SR ³	570	710	21	80

Stress relieved: SR¹ = 740 ±14°C/1h, SR² = 750-770°C/1h, SR³ = 2h/730-760°C

PACKAGING AND AVAILABLE SIZES

SRP	Diameter (mm)	2.5	3.2	4.0
	Length (mm)	350	350	350
SRP	Pieces / unit	66	50	28
	Net weight/unit (kg)	1.4	1.8	1.5

Identification Imprint: 9016-B9 / SL 9 Cr(P91) Tip Color: dark green

SL® 9Cr(P91): rev. C-EN24-01/02/16

All information in this data sheet is accurate to the best of our knowledge at the time of printing. Please refer to www.lincolnelectric.eu for any updated information.
 Fumes: Safety Data Sheets (SDS) are available on our website.

SL[®] 9Cr(P91)

SMAW

EXAMPLES OF MATERIALS TO BE WELDED

Steel grades/Code	Type	Code	Type
Creep resistant steels			
EN 10222-2 / EN 10302	X10CrMoVNb9-1 (1.4903)		
ASTM	A199 Grade T91 A200 Grade T91 A213 Grade T91/P91 A335 Grade P91 A336 Grade F91	ASME	SA 182-F91 SA 213-T91 SA 335-P91 SA 336-F91 SA 369-FP91 SA 387-Grade 91

CALCULATION DATA

Sizes Diam. x length (mm)	Current range (A)	Current type	Arc time	Energy	Dep. rate	Weight/ 1000 pcs (kg)	Electrodes/ kg weldmetal B	kg electrodes/ kg weldmetal 1/N
			- per electrode at max. current - [S]*	E(kJ)	H(kg/h)			
2.5x350	60-90	DC+	57	88	0.7	19.3	92	1.78
3.2x350	85-130	DC+	65	172	1.0	34.8	59	2.04
4.0x350	130-175	DC+	66	263	1.5	50.8	36	1.81

*Stub end 35mm

WELDING PARAMETERS, OPTIMUM FILL PASSES

Diameter (mm)	Welding positions					
	PA/1G	PB/2F	PC/2G	PF/3Gup	PE/4G	PH/5Gup
2.5	80A	80A	75A	70A	70A	70A
3.2	130A	130A	125A	120A	120A	120A
4.0	140A	140A	135A	135A	135A	135A

REMARKS / APPLICATION ADVICE

Recommended preheat temperature: 200 - 300°C
 Postweld heat treatment 730 - 760°C (time depends on material thickness)

Arosta® 304L

EMR
SAHARA®

CLASSIFICATION

AWS A5.4	E308L-16	A-Nr	8	Mat-Nr	1.4316
ISO 3581-A	E 19 9 L R 12	F-Nr	5		
		9606 FM	5		

TEMPERATURE RANGE

Pressurized parts : -196...+350°C
Oxidation resistance : to 800°C

GENERAL DESCRIPTION

Rutile basic all position stainless steel electrode for 304L or equivalent steels
Excellent corrosion resistance in oxidizing environments such as nitric acid
High resistance to intergranular corrosion
Smooth bead appearance
Easy slag release
Strong electrode coating
Weldable on AC and DC

WELDING POSITIONS (ISO/ASME)



PA/1G



PB/2F



PC/2G



PF/3Gu



PE/4G



PH/5Gu

CURRENT TYPE

AC / DC +/-

APPROVALS

BV	TÜV	DB
304L	+	+

CHEMICAL COMPOSITION (W%), TYPICAL, ALL WELD METAL

C	Mn	Si	Cr	Ni	FN (acc.WRC 1992)
0.02	0.8	0.8	19.5	9.7	4-10

MECHANICAL PROPERTIES, TYPICAL, ALL WELD METAL

Condition	0.2% Proof strength (N/mm ²)	Tensile strength (N/mm ²)	Elongation (%)	Impact ISO-V(J)		
				+20°C	-20°C	-196°C
Required: AWS A5.4 ISO 3581-A	not required	min. 520	min. 35	not required		
Typical values	AW 440	580	43	70	60	24

PACKAGING AND AVAILABLE SIZES

	Diameter (mm)	Length (mm)	Available Sizes				
			2.0	2.5	3.2	4.0	5.0
Carton + PE foil	Pieces / unit		225	135	150	85	65
	Net weight/unit (kg)		2.3	2.6	4.8	4.9	4.8
SRP	Pieces / unit		-	69	56	-	-
	Net weight/unit (kg)		-	1.4	1.9	-	-

Identification Imprint: 308L-16 / AROSTA 304L Tip Color: light blue

Arosta® 304L: rev. C-EN26-12/05/16

All information in this data sheet is accurate to the best of our knowledge at the time of printing. Please refer to www.lincolnelectric.eu for any updated information.
Fumes: Safety Data Sheets (SDS) are available on our website.

Arosta® 304L

EXAMPLES OF MATERIALS TO BE WELDED

Steel grades	EN 10088-1/-2	EN 10213-4	Mat. Nr	ASTM/ACI A240/A312/A351	UNS
Extra low carbon [C <0.03%]					
	X2CrNi19-11		1.4306	(TP)304L CF-3	S30403 J92500
	X2CrNi18-10		1.4311	(TP)304LN 302,304	S30453 S30400
Medium carbon [C >0.03%]					
	X4CrNi18-10		1.4301	(TP)304	S30409
		GX5CrNi19-10	1.4308	CF 8	J92600
Ti-, Nb stabilized					
	X6CrNiTi18-10		1.4541	(TP)321 (TP)321H	S32100 S32109
	X6CrNiNb18-10		1.4550	(TP)347 (TP)347H	S34700 S34709
		GX5CrNiNb19-10	1.4552	CF-8C	J92710

SMAW

CALCULATION DATA

Sizes Diam. x length (mm)	Current range (A)	Current type	Arc time	Energy	Dep. rate	Weight/ 1000 pcs (kg)	Electrodes/ kg weldmetal B	kg electrodes/ kg weldmetal 1/N
			- per electrode at max. current - (S)*	E(kJ)	H(kg/h)			
2.0 x 300	30-50	DC+	43	45	0.55	10.4	154	1.59
2.5 x 350	40-75	DC+	51	88	0.86	19.2	82	1.59
3.2 x 350	60-110	DC+	57	158	1.3	32.2	49	1.59
4.0 x 350	80-150	DC+	65	245	1.7	47.3	32	1.52
5.0 x 350	140-220	DC+	66	390	2.7	76.7	20	1.56

*Stub end 35mm

WELDING PARAMETERS, OPTIMUM FILL PASSES

Diameter (mm)	Welding positions					
	PA/1G	PB/2F	PC/2G	PF/3Gup	PE/4G	PH/5Gup
2.0		45A	45A	40A	40A	40A
2.5	70A	70A	70A	60A	60A	60A
3.2	100A	100A	100A	70A	70A	70A
4.0	140A	140A	140A	80A		
5.0	180A	180A	180A			

For root pass, DC- is recommended

Limarosta® 304L

EMR SAHARA®

SMAW

CLASSIFICATION

AWS A5.4	E308L-17	A-Nr	8	Mat-Nr	1.4316
ISO 3581-A	E 19 9 L R 12	F-Nr	5		
		9606 FM	5		

TEMPERATURE RANGE

Pressurized parts : -196...+350°C
Oxidation resistance : to 800°C

GENERAL DESCRIPTION

A rutile-basic all position stainless steel electrode for 304L or equivalent steels
Mirror like bead appearance
Self releasing slag
Excellent side wall wetting, no undercut
High resistance to porosity
Weldable on AC and DC
Also available in vacuum sealed Sahara ReadyPack® [SRP]
Arosta® 304L, diam. 2.5 mm, is recommended for welding root pass

WELDING POSITIONS (ISO/ASME)



CURRENT TYPE

AC / DC + / -

APPROVALS

DNV	GL	LR	RMRS	TÜV
308LH10	4550	304L	304L	+

CHEMICAL COMPOSITION (W%), TYPICAL, ALL WELD METAL

C	Mn	Si	Cr	Ni	FN [acc.WRC 1992]
0.025	0.75	0.95	19.0	9.7	4-10

MECHANICAL PROPERTIES, TYPICAL, ALL WELD METAL

Condition	0.2% Proof strength (N/mm²)	Tensile strength (N/mm²)	Elongation (%)	Impact ISO-V(J)	
				+20°C	-20°C
Required: AWS A5.4 ISO 3581-A Typical values	not required min. 320 440	min. 520 min. 510 600	min. 35 min. 30 45	not required not required 75	not required not required 60

PACKAGING AND AVAILABLE SIZES

	Diameter (mm) Length (mm)	2.0	2.5	3.2	4.0	5.0
		300	350	350	450	450
Carton + PE foil	Pieces / unit	125	125	135	85	55
	Net weight/unit (kg)	2.3	2.7	4.7	5.8	5.8
SRP	Pieces / unit	-	65	52	28	22
	Net weight/unit (kg)	-	1.4	1.8	2.0	2.4
Linc Can™	Pieces / unit	-	203	124	78	48
	Net weight/unit (kg)	-	4.4	4.3	5.3	3.5

Identification Imprint: 308L-17 / LIMAROSTA 304 L Tip Color: light blue

Limarosta® 304L: rev. C-EN25-01/02/16

All information in this data sheet is accurate to the best of our knowledge at the time of printing. Please refer to www.lincolnelectric.eu for any updated information.
Fumes: Safety Data Sheets (SDS) are available on our website.

Limarosta® 304L

EXAMPLES OF MATERIALS TO BE WELDED

Steel grades	EN 10088-1/-2	EN 10213-4	Mat. Nr	ASTM/ACI A240/A312/A351	UNS
Extra low carbon [C <0.03%]					
	X2CrNi19-11		1.4306	(TP)304L CF-3	S30403 J92500
	X2CrNi18-10		1.4311	(TP)304LN 302,304	S30453 S30400
Medium carbon [C >0.03%]					
	X4CrNi18-10		1.4301 1.4308	(TP)304 CF 8	S30409 J92600
		GX5CrNi19-10			
Ti-, Nb stabilized					
	X6CrNiTi18-10		1.4541	(TP)321 (TP)321H	S32100 S32109
	X6CrNiNb18-10		1.4550	(TP)347 (TP)347H	S34700 S34709
		GX5CrNiNb19-10	1.4552	CF-8C	J92710

SMAW

CALCULATION DATA

Sizes Diam. x length (mm)	Current range (A)	Current type	Arc time - per electrode at max. current -		Dep. rate H(kg/h)	Weight/ 1000 pcs (kg)	Electrodes/ kg weldmetal B	kg electrodes/ kg weldmetal 1/N
			(S)*	E(kJ)				
2.0 x 300	35 - 50	DC+	40	51	0.59	11.6	151	1.75
2.5 x 350	45 - 80	DC+	51	103	0.88	21.7	81	1.75
3.2 x 350	80 - 115	DC+	57	177	1.3	34.3	48	1.64
4.0 x 450	100 - 155	DC+	83	373	1.8	68.0	24	1.64
5.0 x 450	150 - 220	DC+	85	577	2.7	106.2	16	1.67

*Stub end 35mm

WELDING PARAMETERS, OPTIMUM FILL PASSES

Diameter (mm)	Welding positions					
	PA/1G	PB/2F	PC/2G	PF/3Gup	PE/4G	PH/5Gup
2.0		45A	45A	40A	40A	40A
2.5	70A	70A	70A	60A	60A	60A
3.2	100A	100A	100A	70A	70A	70A
4.0	140A	140A	140A			
5.0	180A	180A				

Vertarosta® 304L

EMR
SAHARA®

CLASSIFICATION

AWS A5.4	E308L-15	A-Nr	8	Mat-Nr	1.4316
ISO 3581-A	E 19 9 L R 2 1	F-Nr	5		
		9606 FM	5		

TEMPERATURE RANGE

Pressurized parts : -196...+350°C
Oxidation resistance : to 800°C

GENERAL DESCRIPTION

A rutile-basic all position stainless steel electrode for 304L or equivalent steels
 Specially developed for vertical down welding on DC
 Root pass in grooves with root opening
 High corrosion resistance in oxidizing environments

WELDING POSITIONS (ISO/ASME)



PG/3Gd

CURRENT TYPE

DC +

APPROVALS

TÜV DB

+ +

CHEMICAL COMPOSITION (W%), TYPICAL, ALL WELD METAL

C	Mn	Si	Cr	Ni	FN (acc.WRC 1992)
0.02	0.8	0.7	20.0	9.8	4-10

MECHANICAL PROPERTIES, TYPICAL, ALL WELD METAL

Condition	0.2% Proof strength (N/mm ²)	Tensile strength (N/mm ²)	Elongation (%)	Impact ISO-V(J)		
				+20°C	-20°C	-120°C
Required: AWS A5.4 ISO 3581-A Typical values	not required min. 320	min. 520 min. 510	min. 35 min. 30	not required not required		
AW	440	600	40	70	50	40

PACKAGING AND AVAILABLE SIZES

Carton + PE foil	Diameter (mm)	2.5	3.2
	Length (mm)	300	300
Pieces / unit Net weight/unit (kg)		190	130
		2.9	3.1

Identification Imprint: 308L-15 / VERTAROSTA 304 L Tip Color: grey

Vertarosta® 304L: rev. C-EN24-01/02/16

All information in this data sheet is accurate to the best of our knowledge at the time of printing. Please refer to www.lincolnelectric.eu for any updated information.
 Fumes: Safety Data Sheets (SDS) are available on our website.

Vertarosta® 304L

SMAW

EXAMPLES OF MATERIALS TO BE WELDED

Steel grades	EN 10088-1/-2	EN 10213-4	Mat. Nr	ASTM/ACI A240/A312/A351	UNS
Extra low carbon [C <0.03%]					
	X2CrNi19-11		1.4306	(TP)304L CF-3	S30403 J92500
	X2CrNi18-10		1.4311	(TP)304LN 302,304	S30453 S30400
Medium carbon [C >0.03%]					
	X4CrNi18-10		1.4301 1.4308	(TP)304 CF 8	S30409 J92600
		GX5CrNi19-10			
Ti-, Nb stabilized					
	X6CrNiTi18-10		1.4541	(TP)321 (TP)321H	S32100 S32109
	X6CrNiNb18-10		1.4550	(TP)347 (TP)347H	S34700 S34709
		GX5CrNiNb19-10	1.4552	CF-8C	J92710

CALCULATION DATA

Sizes Diam. x length (mm)	Current range (A)	Current type	Arc time	Energy	Dep. rate	Weight/ 1000 pcs (kg)	Electrodes/ kg weldmetal B	kg electrodes/ kg weldmetal 1/N
			- per electrode at max. current - (S)*	E(kJ)	H(kg/h)			
2.5 x 300	60-70	DC+	44	65	0.81	15.0	101	1.52
3.2 x 300	80-110	DC+	51	117	1.2	23.5	59	1.39

*Stub end 35mm

WELDING PARAMETERS, OPTIMUM FILL PASSES

Diameter (mm)	Welding positions PG/3Gdown
2.5	70A
3.2	100A

Jungo® 304L

CLASSIFICATION

AWS A5.4	E308L-15	A-Nr	8	Mat-Nr	1.4316
ISO 3581-A	E 19 9 L B 2 2	F-Nr	5		
		9606 FM	5		

TEMPERATURE RANGE

Pressurized parts : -196...+350°C
Oxidation resistance : to 800°C

GENERAL DESCRIPTION

Basic coated electrode for low temperature applications
 Low carbon content, good impact properties down to -196°C
 Good weldability and smooth bead appearance
 High resistance against oxidation up to 800°C
 Welding on DC electrode + is recommended

WELDING POSITIONS (ISO/ASME)



PA/1G



PB/2F



PC/2G



PF/3Gu



PE/4G



PH/5Gu

CURRENT TYPE

DC +

APPROVALS

TÜV

+

CHEMICAL COMPOSITION (W%), TYPICAL, ALL WELD METAL

C	Mn	Si	Cr	Ni	FN (acc.WRC 1992)
0.025	1.8	0.4	19.0	10.0	4-10

MECHANICAL PROPERTIES, TYPICAL, ALL WELD METAL

Condition	0.2% Proof strength [N/mm ²]	Tensile strength [N/mm ²]	Elongation [%]	Impact ISO-V(J)	
				+20°C	-196°C
Required: AWS A5.4 ISO 3581-A Typical values	not required min. 320 400	min. 520 min. 510 600	min. 35 min. 30 40	not required not required 80	
AW					40

PACKAGING AND AVAILABLE SIZES

Carton + PE foil	Diameter (mm)	2.5	3.2	4.0
	Length (mm)	350	350	350
Pieces / unit	120	150	100	
Net weight/unit (kg)	2.4	4.8	4.8	

Identification Imprint: 308L-15 / JUNGO 304 L Tip Color: dark blue

Jungo® 304L: rev. C-EN24-01/02/16

All information in this data sheet is accurate to the best of our knowledge at the time of printing. Please refer to www.lincolnelectric.eu for any updated information.
 Fumes: Safety Data Sheets (SDS) are available on our website.

Jungo® 304L

EXAMPLES OF MATERIALS TO BE WELDED

Steel grades	EN 10088-1/-2	EN 10213-4	Mat. Nr	ASTM/ACI A240/A312/A351	UNS
Extra low carbon [C <0.03%]					
	X2CrNi19-11		1.4306	(TP)304L CF-3	S30403 J92500
	X2CrNi18-10		1.4311	(TP)304LN 302,304	S30453 S30400
Medium carbon [C >0.03%]					
	X4CrNi18-10		1.4301 1.4308	(TP)304 CF 8	S30409 J92600
		GX5CrNi19-10			
Ti-, Nb stabilized					
	X6CrNiTi18-10		1.4541	(TP)321 (TP)321H	S32100 S32109
	X6CrNiNb18-10		1.4550	(TP)347 (TP)347H	S34700 S34709
		GX5CrNiNb19-10	1.4552	CF-8C	J92710

SMAW

CALCULATION DATA

Sizes		Current range (A)	Current type	Arc time		Dep. rate H(kg/h)	Weight/ 1000 pcs (kg)	Electrodes/ kg weldmetal B	kg electrodes/ kg weldmetal 1/N
Diam. x length (mm)	Current range (A)			- per electrode at max. current - (S)*	Energy E(kJ)				
2.5 x 350	55-65	DC+	50	86	0.82	19.1	88	1.89	
3.2 x 350	70-90	DC+	51	135	1.3	31.6	53	1.72	
4.0 x 350	90-120	DC+	66	206	1.7	47.0	32	1.56	

*Stub end 35mm

WELDING PARAMETERS, OPTIMUM FILL PASSES

Diameter (mm)	Welding positions					
	PA/1G	PB/2F	PC/2G	PF/3Gup	PE/4G	PH/5Gup
2.5	60A	60A	60A	60A	60A	60A
3.2	95A	90A	90A	75A	75A	75A
4.0	125A	110A	125A	100A	100A	100A

Arosta® 347

EMR
SAHARA®

SMAW

CLASSIFICATION

AWS A5.4	E347-16	A-Nr	8	Mat-Nr	1.4551
ISO 3581-A	E 19 9 Nb R 12	F-Nr	5		
		9606 FM	5		

TEMPERATURE RANGE

Pressurized parts : -120...+400°C
Oxidation resistance : to 800°C

GENERAL DESCRIPTION

Rutile-basic all position stainless steel electrode
 For Ti or Nb stabilized 304 or equivalent steels (AISI 321 and 347)
 High resistance to intergranular corrosion
 Easy slag release and smooth bead appearance
 Strong electrode coating
 Weldable on AC and DC
 Also available in vacuum sealed Sahara ReadyPack® (SRP)

WELDING POSITIONS (ISO/ASME)

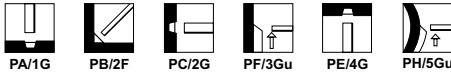

CURRENT TYPE

AC / DC + / -

APPROVALS

TÜV	DB
+	+

CHEMICAL COMPOSITION (W%), TYPICAL, ALL WELD METAL

C	Mn	Si	Cr	Ni	Nb	FN [acc.WRC 1992]
0.03	0.8	0.8	19.5	9.8	0.35	6-12

MECHANICAL PROPERTIES, TYPICAL, ALL WELD METAL

Condition	0.2% Proof strength [N/mm²]	Tensile strength [N/mm²]	Elongation [%]	Impact ISO-V(J)		
				+20°C	-20°C	-60°C
Required: AWS A5.4 ISO 3581-A Typical values	not required min. 350 500	min. 550 min. 550 630	min. 25 min. 25 35	not required not required 70	50	35
AW						

PACKAGING AND AVAILABLE SIZES

	Diameter (mm)	2.5	3.2	4.0
	Length (mm)	350	350	350
Carton + PE foil	Pieces / unit	120	130	90
	Net weight/unit (kg)	2.6	4.7	4.9
SRP	Pieces / unit	69	52	-
	Net weight/unit (kg)	1.4	1.8	-

Identification Imprint: 347-16 / AROSTA 347 Tip Color: gold

Arosta® 347; rev. C-EN24-01/02/16

All information in this data sheet is accurate to the best of our knowledge at the time of printing. Please refer to www.lincolnelectric.eu for any updated information.
 Fumes: Safety Data Sheets (SDS) are available on our website.

Arosta® 347

SMAW

EXAMPLES OF MATERIALS TO BE WELDED

Steel grades	EN 10088-1/-2	EN 10213-4	Mat. Nr	ASTM/AISI A240/A312/A351	UNS
Ti-, Nb stabilized					
	X6CrNiTi18-10		1.4541	(TP)321 (TP)321H	S32100 S32109
	X6CrNiNb18-10		1.4550	(TP)347 (TP)347H	S34700 S34709
		GX5CrNiNb19-10	1.4552	CF-8C 302	J92710
Non stabilized					
	X4CrNi18-10		1.4301	(TP)304	S30400
	X2CrNi19-11		1.4306	(TP)304L	S30403
		GX5CrNi19-10	1.4308	CF-8	J92600
			1.4312	(TP)304H	S30409

CALCULATION DATA

Sizes		Current range (A)	Current type	Arc time	Energy	Dep. rate	Weight/ 1000 pcs (kg)	Electrodes/ kg weldmetal B	kg electrodes/ kg weldmetal 1/N
Diam. x length (mm)	- per electrode at max. current - (S)*			E(kJ)	H(kg/h)				
2.5 x 350	40-75	DC+	52	78	0.87	20.7	80	1.66	
3.2 x 350	60-110	DC+	54	119	1.4	34.9	48	1.67	
4.0 x 350	80-150	DC+	64	210	1.7	49.0	33	1.61	

*Stub end 35mm

WELDING PARAMETERS, OPTIMUM FILL PASSES

Diameter (mm)	Welding positions					
	PA/1G	PB/2F	PC/2G	PF/3Gup	PE/4G	PH/5Gup
2.5	70A	70A	70A	60A	60A	60A
3.2	100A	100A	100A	70A	70A	70A
4.0	140A	140A	140A	80A		

For root pass, DC- is recommended

Jungo® 347

SMAW

CLASSIFICATION

AWS A5.4	E347-15	A-Nr	8	Mat-Nr	1.4551
ISO 3581-A	E 19 9 Nb B 2 2	F-Nr	5		
		9606 FM	5		

TEMPERATURE RANGE

Pressurized parts : -120...+400°C
Oxidation resistance : to 800°C

GENERAL DESCRIPTION

Basic coated all position stainless steel electrode
 For Ti or Nb stabilized 304 or equivalent steels (AISI 321 and 347)
 High resistance to intergranular corrosion
 Easy slag release and smooth bead appearance
 Strong electrode coating

WELDING POSITIONS (ISO/ASME)



PA/1G



PB/2F



PC/2G



PF/3Gu



PE/4G



PH/5Gu

CURRENT TYPE

DC +

APPROVALS

TÜV

+

CHEMICAL COMPOSITION (W%), TYPICAL, ALL WELD METAL

C	Mn	Si	Cr	Ni	Nb	FN (acc.WRC 1992)
0.02	1.6	0.5	20.0	10.0	0.40	6-12

MECHANICAL PROPERTIES, TYPICAL, ALL WELD METAL

Condition	0.2% Proof strength [N/mm ²]	Tensile strength [N/mm ²]	Elongation [%]	Impact ISO-V(J)		
				+20°C	-20°C	-120°C
Required: AWS A5.4 ISO 3581-A Typical values	not required min. 350 500	min. 520 min. 550 630	min. 30 min. 25 35	not required not required 80	50	40
AW						

PACKAGING AND AVAILABLE SIZES

Carton + PE foil	Diameter (mm)	2.5	3.2	4.0
	Length (mm)	350	350	350
Pieces / unit		150	100	75
	Net weight/unit (kg)	2.6	4.8	4.4

Identification Imprint: 347-15 / JUNGO 347

Tip Color: brown

Jungo® 347: rev. C-ENZ-01/02/16

All information in this data sheet is accurate to the best of our knowledge at the time of printing. Please refer to www.lincolnelectric.eu for any updated information.
 Fumes: Safety Data Sheets (SDS) are available on our website.

Jungo® 347

EXAMPLES OF MATERIALS TO BE WELDED

Steel grades	EN 10088-1/-2	EN 10213-4	Mat. Nr	ASTM/ACI A240/A312/A351	UNS
Ti-, Nb stabilized					
	X6CrNiTi18-10		1.4541	(TP)321 (TP)321H	S32100 S32109
	X6CrNiNb18-10		1.4550	(TP)347 (TP)347H	S34700 S34709
		GX5CrNiNb19-10	1.4552	CF-8C 302	J92710
Non stabilized					
	X4CrNi18-10		1.4301	(TP)304	S30400
	X2CrNi19-11		1.4306	(TP)304L	S30403
		GX5CrNi19-10	1.4308	CF-8	J92600
			1.4312	(TP)304H	S30409

SMAW

CALCULATION DATA

Sizes		Current range (A)	Current type	Arc time - per electrode at max. current - (S)*	Energy E(kJ)	Dep. rate H(kg/h)	Weight/ 1000 pcs (kg)	Electrodes/ kg weldmetal B	kg electrodes/ kg weldmetal 1/N
Diam. x length (mm)	Current range (A)								
3.2 x 350	80 - 100	DC+	51	135	1.3	32.4	53	1.72	
4.0 x 350	100 - 130	DC+	66	206	1.7	44.4	32	1.56	
5.0 x 450	130 - 160	DC+	69	378	2.3	90.9	23	1.92	

*Stub end 35mm

WELDING PARAMETERS, OPTIMUM FILL PASSES

Diameter (mm)	Welding positions					
	PA/1G	PB/2F	PC/2G	PF/3Gup	PE/4G	PH/5Gup
3.2	95A	90A	90A	75A	75A	75A
4.0	125A	110A	125A	100A	100A	100A
5.0	150A	150A				

Arosta® 316L

EMR
SAHARA®

SMAW

CLASSIFICATION

AWS A5.4	E316L-16	A-Nr	8	Mat-Nr	1.4430
ISO 3581-A	E 19 12 3 L R 1 2	F-Nr	5		
		9606 FM	5		

TEMPERATURE RANGE

Pressurized parts : -120...+350°C
Oxidation resistance : n.a

GENERAL DESCRIPTION

Rutile-basic all position stainless steel electrode for 316L or equivalent steels
Molybdenum level min. 2.7 %
High resistance to general and intergranular corrosion
Smooth weld appearance
Easy slag release
Strong electrode coating
Weldable on AC and DC
Also available in vacuum sealed Sahara ReadyPack® (SRP)

WELDING POSITIONS (ISO/ASME)

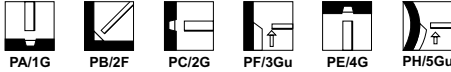

CURRENT TYPE

AC / DC +/-

APPROVALS

ABS	BV	DNV	GL	LR	RINA	RMRS	TÜV	DB
+	316L	316L	4571	316L	316L	316L	+	+

CHEMICAL COMPOSITION (W%), TYPICAL, ALL WELD METAL

C	Mn	Si	Cr	Ni	Mo	FN [acc.WRC 1992]
0.02	0.8	0.8	18.0	11.5	2.85	4-10

MECHANICAL PROPERTIES, TYPICAL, ALL WELD METAL

Condition	0.2% Proof strength (N/mm²)	Tensile strength (N/mm²)	Elongation (%)	Impact ISO-V(J)		
				+20°C	-20°C	-120°C
Required: AWS A5.4 ISO 3581-A Typical values	not required min. 320 450	min. 490 min. 510 580	min. 30 min. 25 39	not required not required	60	40

PACKAGING AND AVAILABLE SIZES

	Diameter (mm) Length (mm)	1.5	2.0	2.5	3.2	4.0	5.0
		250	300	350	350	350	350
carton box	Pieces / unit Net weight/unit (kg)	140 0.7	200 2.3	135 2.7	150 4.9	90 4.8	65 5.0
SRP	Pieces / unit Net weight/unit (kg)	- -	- -	69 1.4	56 1.8	- -	- -
Linc Can™	Pieces / unit Net weight/unit (kg)	- -	- -	217 4.7	134 4.4	80 4.2	- -

Identification Imprint: 316L-16 / AROSTA 316 L Tip Color: pink

Arosta® 316L: rev. C-ENZ-12/05/16

Arosta® 316L

SMAW

EXAMPLES OF MATERIALS TO BE WELDED

Steel grades	EN 10088-1/-2	EN 10213-4	Mat. Nr	ASTM/ACI A240/A312/A351	UNS
Extra low carbon [C <0.03%]					
	X2CrNiMo17-12-2		1.4404	(TP)316L CF-3M	S31603 J92800
	X2CrNiMo18-14-3		1.4435	(TP)316L	S31603
	X2CrNiMoN17-11-2		1.4406	(TP)316LN	S31653
	X2CrNiMoN17-13-3		1.4429		
Medium carbon [C >0.03%]					
	X4CrNiMo17-12-2		1.4401	(TP)316	S31600
	X4CrNiMo17-13-3		1.4436		
		GX5CrNiMo19-11	1.4408	CF 8M	J92900
Ti-, Nb stabilized					
	X6CrNiMoTi17-12-2		1.4571	316Ti	S31635
	X6CrNiMoNb17-12-2		1.4580	316Cb	S31640
	X6CrNiNb18-10		1.4550	(TP)347	S34700
		GX5CrNiNb19-10	1.4552	CF-8C	J92710

CALCULATION DATA

Sizes Diam. x length (mm)	Current range (A)	Current type	Arc time	Energy	Dep. rate	Weight/ 1000 pcs (kg)	Electrodes/ kg weldmetal B	kg electrodes/ kg weldmetal 1/N
			- per electrode at max. current - [S]*	E(kJ)	H(kg/h)			
1.5 x 250	20 - 40	DC+	25	19	0.44	5.8	330	1.92
2.0 x 300	30 - 50	DC+	42	44	0.58	10.7	150	1.61
2.5 x 350	40 - 75	DC+	50	86	0.88	19.9	82	1.61
3.2 x 350	60 - 110	DC+	57	157	1.3	32.9	49	1.61
4.0 x 350	80 - 150	DC+	64	240	1.7	49.2	32	1.59
5.0 x 350	140 - 220	DC+	67	396	2.6	77.1	20	1.59

*Stub end 35mm

WELDING PARAMETERS, OPTIMUM FILL PASSES

Diameter (mm)	Welding positions					
	PA/1G	PB/2F	PC/2G	PF/3Gup	PE/4G	PH/5Gup
1.5	30A	35A	35A			
2.0	40A	45A	45A	40A	40A	40A
2.5	70A	70A	70A	60A	60A	60A
3.2	100A	100A	100A	70A	70A	70A
4.0	140A	140A	140A	80A		
5.0	180A	180A	180A			

For root pass, DC- is recommended

Limarosta® 316L

EMR
SAHARA®

SMAW

CLASSIFICATION

AWS A5.4	E316L-17	A-Nr	8	Mat-Nr	1.4430
ISO 3581-A	E 19 12 3 L R 12	F-Nr	5		
		9606 FM	5		

TEMPERATURE RANGE

Pressurized parts : -120...+350°C
Oxidation resistance : n.a

GENERAL DESCRIPTION

A rutile-basic all position stainless steel electrode for 316L or equivalent steels
Molybdenum level min. 2.7%
Mirror like bead appearance
Self releasing slag
Good side wall fusion, no undercut
High resistance to porosity
Weldable on AC and DC
Also available in vacuum sealed Sahara ReadyPack® (SRP)
Arosta® 316L is recommended for welding root pass

WELDING POSITIONS (ISO/ASME)



CURRENT TYPE

AC / DC +/-

APPROVALS

DNV	LR	RMRS	TÜV
316LH10	316L	316L	+

CHEMICAL COMPOSITION (W%), TYPICAL, ALL WELD METAL

C	Mn	Si	Cr	Ni	Mo	FN (acc.WRC 1992)
0.02	0.8	1.0	18.0	11.5	2.8	4-10

MECHANICAL PROPERTIES, TYPICAL, ALL WELD METAL

Condition	0.2% Proof strength [N/mm²]	Tensile strength [N/mm²]	Elongation [%]	Impact ISO-V[J]		
				+20°C	-20°C	-105°C
Required: AWS A5.4 ISO 3581-A Typical values	not required min. 320	min. 490 min. 510	min. 30 min. 25	not required not required		
AW	450	580	40	70	60	40

PACKAGING AND AVAILABLE SIZES

	Diameter (mm) Length (mm)	1.5	2.0	2.5	3.2	4.0	5.0
		Carton + PE foil	Pieces / unit Net weight/unit (kg)	140 0.7	200 2.3	125 2.7	135 4.8
SRP	Pieces / unit Net weight/unit (kg)	- -	57 0.6	65 1.5	52 1.8	28 2.0	22 2.4
Linc Can™	Pieces / unit Net weight/unit (kg)	- -	- -	195 4.3	124 4.3	79 5.3	- -

Identification Imprint: 316L-17 / LIMAROSTA 316 L Tip Color: pink

Limarosta® 316L rev. C-EN25-01/02/16

All information in this data sheet is accurate to the best of our knowledge at the time of printing. Please refer to www.lincolnelectric.eu for any updated information.
Fumes: Safety Data Sheets (SDS) are available on our website.

Limarosta® 316L

SMAW

EXAMPLES OF MATERIALS TO BE WELDED

Steel grades	EN 10088-1/-2	EN 10213-4	Mat. Nr	ASTM/ACI A240/A312/A351	UNS
Extra low carbon [C <0.03%]					
	X2CrNiMo17-12-2		1.4404	(TP)316L CF-3M	S31603 J92800
	X2CrNiMo18-14-3		1.4435	(TP)316L	S31603
	X2CrNiMoN17-11-2		1.4406	(TP)316LN	S31653
	X2CrNiMoN17-13-3		1.4429		
Medium carbon [C >0.03%]					
	X4CrNiMo17-12-2		1.4401	(TP)316	S31600
	X4CrNiMo17-13-3		1.4436		
		GX5CrNiMo19-11	1.4408	CF 8M	J92900
Ti-, Nb stabilized					
	X6CrNiMoTi17-12-2		1.4571	316Ti	S31635
	X6CrNiMoNb17-12-2		1.4580	316Cb	S31640
	X6CrNiNb18-10		1.4550	(TP)347	S34700
		GX5CrNiNb19-10	1.4552	CF-8C	J92710

CALCULATION DATA

Sizes Diam. x length (mm)	Current range (A)	Current type	Arc time - per electrode at max. current - (S)*	Energy E(kJ)	Dep. rate H(kg/h)	Weight/ 1000 pcs (kg)	Electrodes/ kg weldmetal B	kg electrodes/ kg weldmetal 1/N
1.5 x 250	20-40							
2.0 x 300	35-50	DC+	39	49	0.59	11.4	155	1.79
2.5 x 350	45-80	DC+	46	92	0.95	21.5	83	1.79
3.2 x 350	80-115	DC+	51	157	1.5	35.3	48	1.69
4.0 x 450	100-155	DC+	75	339	1.9	69.2	24	1.69
5.0 x 450	150-220	DC+	85	577	2.7	107.8	16	1.69

*Stub end 35mm

WELDING PARAMETERS, OPTIMUM FILL PASSES

Diameter (mm)	Welding positions					
	PA/1G	PB/2F	PC/2G	PF/3Gup	PE/4G	PH/5Gup
1.5	30A	35A	35A			
2.0	40A	45A	45A	40A	40A	40A
2.5	70A	70A	70A	60A	60A	60A
3.2	100A	100A	100A	70A	70A	70A
4.0	140A	140A	140A			
5.0	180A	180A				

Vertarosta® 316L

EMR
SAHARA®

SMAW

CLASSIFICATION

AWS A5.4	E316L-15	A-Nr	8	Mat-Nr	1.4430
ISO 3581-A	E 19 12 3 L R 2 1	F-Nr	5		
		9606 FM	5		

TEMPERATURE RANGE

Pressurized parts : -60...+350°C
Oxidation resistance : n.a

GENERAL DESCRIPTION

A rutile-basic all position stainless steel electrode for 316L or equivalent steels
Molybdenum level min. 2.7 %
Specially developed for vertical down welding on DC
Root passes in grooves with root opening
High general corrosion resistance

WELDING POSITIONS (ISO/ASME)



PG/3Gd

CURRENT TYPE

AC/DC +

APPROVALS

ABS	BV	DNV	GL	LR	TÜV
+	316L	316L	4429	316L	+

CHEMICAL COMPOSITION (W%), TYPICAL, ALL WELD METAL

C	Mn	Si	Cr	Ni	Mo	FN (acc.WRC 1992)
0.02	0.7	0.85	18.0	11.5	2.8	4-10

MECHANICAL PROPERTIES, TYPICAL, ALL WELD METAL

Condition	0.2% Proof strength [N/mm ²]	Tensile strength [N/mm ²]	Elongation [%]	Impact ISO-V(J)		
				+20°C	-20°C	-60°C
Required: AWS A5.4 ISO 3581-A Typical values	not required min. 320 500	min. 490 min. 510 620	min. 30 min. 25 35	not required not required 50	45	35

PACKAGING AND AVAILABLE SIZES

Carton + PE foil	Diameter (mm)	2.5	3.2	
	Length (mm)	300	300	
Pieces / unit Net weight/unit (kg)	AW		190	130
			2.9	3.1

Identification Imprint: 316L-15 / VERTAROSTA 316 L Tip Color: brown

Vertarosta® 316L: rev. C-EN24-01/02/16

All information in this data sheet is accurate to the best of our knowledge at the time of printing. Please refer to www.lincolnelectric.eu for any updated information.
Fumes: Safety Data Sheets (SDS) are available on our website.

Vertarosta® 316L

SMAW

EXAMPLES OF MATERIALS TO BE WELDED

Steel grades	EN 10088-1/-2	EN 10213-4	Mat. Nr	ASTM/ACI A240/A312/A351	UNS
Extra low carbon [C <0.03%]					
	X2CrNiMo17-12-2		1.4404	(TP)316L CF-3M	S31603 J92800
	X2CrNiMo18-14-3		1.4435	(TP)316L	S31603
	X2CrNiMoN17-11-2		1.4406	(TP)316LN	S31653
	X2CrNiMoN17-13-3		1.4429		
Medium carbon [C >0.03%]					
	X4CrNiMo17-12-2		1.4401	(TP)316	S31600
	X4CrNiMo17-13-3		1.4436		
		GX5CrNiMo19-11	1.4408	CF 8M	J92900
Ti-, Nb stabilized					
	X6CrNiMoTi17-12-2		1.4571	316Ti	S31635
	X6CrNiMoNb17-12-2		1.4580	316Cb	S31640
	X6CrNiNb18-10		1.4550	(TP)347	S34700
		GX5CrNiNb19-10	1.4552	CF-8C	J92710

CALCULATION DATA

Sizes Diam. x length (mm)	Current range (A)	Current type	Arc time	Energy	Dep. rate	Weight/ 1000 pcs (kg)	Electrodes/ kg weldmetal B	kg electrodes/ kg weldmetal 1/N
			- per electrode at max. current - (S)*	E(kJ)	H(kg/h)			
2.5 x 300	60-70	DC+	44	71	0.83	14.9	98	1.47
3.2 x 300	80-110	DC+	47	118	1.3	23.9	59	1.41

*Stub end 35mm

WELDING PARAMETERS, OPTIMUM FILL PASSES

Diameter (mm)	Welding positions PG/3Gdown
2.5	70A
3.2	100A

Jungo® 316L

CLASSIFICATION

AWS A5.4	E316L-15	A-Nr	8	Mat-Nr	1.4430
ISO 3581-A	E 19 12 3 L B 2 2	F-Nr	5		
		9606 FM	5		

TEMPERATURE RANGE

Pressurized parts : -120...+350°C
Oxidation resistance : n.a

GENERAL DESCRIPTION

Basic coated electrode for low temperature applications
Good impact values down to -196°C
Good weldability and smooth bead appearance
Low carbon content
High resistance against general and intercrystalline corrosion

WELDING POSITIONS (ISO/ASME)



PA/1G



PB/2F



PC/2G



PF/3Gu



PE/4G



PH/5Gu

CURRENT TYPE

DC +

APPROVALS

BV

316LBT

CHEMICAL COMPOSITION (W%), TYPICAL, ALL WELD METAL

C	Mn	Si	Cr	Ni	Mo	FN [acc.WRC 1992]
0.025	1.6	0.4	18.5	11.0	2.7	4-10

MECHANICAL PROPERTIES, TYPICAL, ALL WELD METAL

Condition	0.2% Proof strength (N/mm ²)	Tensile strength (N/mm ²)	Elongation (%)	Impact ISO-V(J)	
				+20°C	-196°C
Required: AWS A5.4 ISO 3581-A Typical values	not required min. 320 450	min. 490 min. 510 650	min. 30 min. 25 35	not required not required 100	
AW					35

PACKAGING AND AVAILABLE SIZES

	Diameter (mm)	2.5	3.2	4.0
	Length (mm)	350	350	350
Carton + PE foil	Pieces / unit	135	150	100
	Net weight/unit (kg)	2.7	4.8	4.8
SRP	Pieces / unit	-	56	30
	Net weight/unit (kg)	-	1.8	1.4

Identification Imprint: 316L-15 / JUNGO 316 L Tip Color: red

Jungo® 316L: rev. C-EN26-01/02/16

All information in this data sheet is accurate to the best of our knowledge at the time of printing. Please refer to www.lincolnelectric.eu for any updated information.
Fumes: Safety Data Sheets (SDS) are available on our website.

Jungo[®] 316L

EXAMPLES OF MATERIALS TO BE WELDED

Steel grades	EN 10088-1/-2	EN 10213-4	Mat. Nr	ASTM/ACI A240/A312/A351	UNS
Extra low carbon [C <0.03%]					
	X2CrNiMo17-12-2		1.4404	(TP)316L CF-3M	S31603 J92800
	X2CrNiMo18-14-3		1.4435	(TP)316L	S31603
	X2CrNiMoN17-11-2		1.4406	(TP)316LN	S31653
	X2CrNiMoN17-13-3		1.4429		
Medium carbon [C >0.03%]					
	X4CrNiMo17-12-2		1.4401	(TP)316	S31600
	X4CrNiMo17-13-3		1.4436		
		GX5CrNiMo19-11	1.4408	CF 8M	J92900
Ti-, Nb stabilized					
	X6CrNiMoTi17-12-2		1.4571	316Ti	S31635
	X6CrNiMoNb17-12-2		1.4580	316Cb	S31640
	X6CrNiNb18-10		1.4550	(TP)347	S34700
		GX5CrNiNb19-10	1.4552	CF-8C	J92710

SMAW

CALCULATION DATA

Sizes Diam. x length (mm)	Current range (A)	Current type	Arc time	Energy	Dep. rate	Weight/ 1000 pcs (kg)	Electrodes/ kg weldmetal B	kg electrodes/ kg weldmetal 1/N
			- per electrode at max. current - (S)*	E(kJ)	H(kg/h)			
2.5 x 350	50-70	DC+	50	86	0.82	19.2	88	1.89
3.2 x 350	60-90	DC+	51	135	1.3	31.3	53	1.72
4.0 x 350	80-120	DC+	66	206	1.7	47.6	32	1.56

*Stub end 35mm

WELDING PARAMETERS, OPTIMUM FILL PASSES

Diameter (mm)	Welding positions					
	PA/1G	PB/2F	PC/2G	PF/3Gup	PE/4G	PH/5Gup
2.5	60A	60A	60A	60A	60A	60A
3.2	95A	90A	90A	75A	75A	75A
4.0	125A	110A	125A	100A	100A	100A

Limarosta® 316L-130

EMR
SAHARA®

CLASSIFICATION

AWS A5.4	E316L-17	A-Nr	8	Mat-Nr	1.4430
ISO 3581-A	E 19 12 3 L R 5 3	F-Nr	5		
		9606 FM	5		

TEMPERATURE RANGE

Pressurized parts : -120...+350°C
Oxidation resistance : n.a

GENERAL DESCRIPTION

A rutile-basic all position stainless steel electrode for 316L or equivalent steels
Molybdenum level min. 2.7 %
High recovery (130%) providing high welding speed
Excellent side wall fusion, no undercut
Only for down hand position
Excellent for fillet welds and filling V- and X-grooves
Weldable on AC and DC+ polarity
Only available in vacuum sealed Sahara ReadyPack® (SRP)

WELDING POSITIONS (ISO/ASME)



PA/1G



PB/2F

CURRENT TYPE

AC / DC +

CHEMICAL COMPOSITION (W%), TYPICAL, ALL WELD METAL

C	Mn	Si	Cr	Ni	Mo	FN [acc.WRC 1992]
0.02	0.65	1.0	18.0	11.5	2.8	4-10

MECHANICAL PROPERTIES, TYPICAL, ALL WELD METAL

Condition	0.2% Proof strength [N/mm ²]	Tensile strength [N/mm ²]	Elongation [%]	Impact ISO-V(J)		
				+20°C	-20°C	-105°C
Required: AWS A5.4 ISO 3581-A Typical values	not required min. 320 450	min. 490 min. 510 580	min. 30 min. 25 40	not required not required 70	60	40
AW						

PACKAGING AND AVAILABLE SIZES

SRP	Diameter (mm)	3.2	4.0	5.0
	Length (mm)	450	450	450
Pieces / unit	29	23	19	
Net weight/unit (kg)	1.7	2.0	2.3	

Identification Imprint: 316L-17 / LIMAROSTA 316 L-130 Tip Color: pink

Limarosta® 316L-130: rev. C-EN24-01/02/16

All information in this data sheet is accurate to the best of our knowledge at the time of printing. Please refer to www.lincolnelectric.eu for any updated information.
Fumes: Safety Data Sheets (SDS) are available on our website.

Limarosta® 316L-130

SMAW

EXAMPLES OF MATERIALS TO BE WELDED

Steel grades	EN 10088-1/-2	EN 10213-4	Mat. Nr	ASTM/ACI A240/A312/A351	UNS
Extra low carbon [C <0.03%]					
	X2CrNiMo17-12-2		1.4404	(TP)316L CF-3M	S31603 J92800
	X2CrNiMo18-14-3		1.4435	(TP)316L	S31603
	X2CrNiMoN17-11-2		1.4406	(TP)316LN	S31653
	X2CrNiMoN17-13-3		1.4429		
Medium carbon [C >0.03%]					
	X4CrNiMo17-12-2		1.4401	(TP)316	S31600
	X4CrNiMo17-13-3		1.4436		
		GX5CrNiMo19-11	1.4408	CF 8M	J92900
Ti-, Nb stabilized					
	X6CrNiMoTi17-12-2		1.4571	316Ti	S31635
	X6CrNiMoNb17-12-2		1.4580	316Cb	S31640
	X6CrNiNb18-10		1.4550	(TP)347	S34700
		GX5CrNiNb19-10	1.4552	CF-8C	J92710

CALCULATION DATA

Sizes		Current range (A)	Current type	Arc time	Energy	Dep. rate	Weight/ 1000 pcs (kg)	Electrodes/ kg weldmetal B	kg electrodes/ kg weldmetal 1/N
Diam. x length (mm)	- per electrode at max. current - (S)*			E(kJ)	H(kg/h)				
3.2 x 450	90-120	DC+	68	227	1.9	60.4	28	1.67	
4.0 x 450	120-160	DC+	78	376	2.5	91.0	18	1.67	
5.0 x 450	160-200	DC+	81	577	3.7	143.7	12	1.72	

*Stub end 35mm

WELDING PARAMETERS, OPTIMUM FILL PASSES

Diameter (mm)	Welding positions	
	PA/1G	PB/2F
3.2	110A	105A
4.0	155A	150A
5.0	175A	175A

Arosta® 318

SMAW

CLASSIFICATION

AWS A5.4	E318-16	A-Nr	8	Mat-Nr	1.4576
ISO 3581-A	E 19 12 3 Nb R 12	F-Nr	5		
		9606 FM	5		

TEMPERATURE RANGE

Pressurized parts : -60...+400°C
Oxidation resistance : n.a

GENERAL DESCRIPTION

Rutile basic all position stainless steel electrodes for welding Ti or Nb stabilized 316 or equivalent steels
High resistance to general and intergranular corrosion
Smooth bead appearance
Easy slag release
Strong electrode coating
Weldable on AC and DC

WELDING POSITIONS (ISO/ASME)



PA/1G



PB/2F



PC/2G



PF/3Gu



PE/4G



PH/5Gu

CURRENT TYPE

AC / DC +/-

APPROVALS

TÜV

+

CHEMICAL COMPOSITION (W%), TYPICAL, ALL WELD METAL

C	Mn	Si	Cr	Ni	Mo	Nb	FN (acc.WRC 1992)
0.03	0.8	0.85	18.0	11.5	2.7	0.35	6-12

MECHANICAL PROPERTIES, TYPICAL, ALL WELD METAL

Condition	0.2% Proof strength (N/mm²)	Tensile strength (N/mm²)	Elongation (%)	Impact ISO-V(J)		
				+20°C	-20°C	-60°C
Required: AWS A5.4 ISO 3581-A Typical values	not required min. 350 500	min.550 min. 550 630	min. 25 min. 25 38	not required not required 60	50	35

PACKAGING AND AVAILABLE SIZES

Carton + PE foil	Diameter (mm)	2.5	3.2	4.0
	Length (mm)	350	350	350
Pieces / unit	Net weight/unit (kg)	135	140	90
		2.8	5.0	4.8

Identification Imprint: 318-16 / AROSTA 318 Tip Color: white

Arosta® 318: rev. C-EN25-01/02/16

All information in this data sheet is accurate to the best of our knowledge at the time of printing. Please refer to www.lincolnelectric.eu for any updated information.
Fumes: Safety Data Sheets (SDS) are available on our website.

Arosta® 318

SMAW

EXAMPLES OF MATERIALS TO BE WELDED

Steel grades	EN 10088-1/-2	EN 10213-4	Mat. Nr	ASTM/ACI A240/A312/A351	UNS
Medium carbon (C > 0.03%)					
	X4CrNiMo17-12-2		1.4401	(TP)316	S31600
	X4CrNiMo17-13-3		1.4436		
		GX5CrNiMo19-11	1.4408	CF 8M	J92900
Ti-, Nb stabilized					
	X6CrNiMoTi17-12-2		1.4571	316Ti	S31635
	X6CrNiMoNb17-12-2		1.4580	316Cb	S31640
	X6CrNiNb18-10		1.4550	(TP)347	S34700
		GX5CrNiNb19-10	1.4552	CF-8C	J92710

CALCULATION DATA

Sizes Diam. x length (mm)	Current range (A)	Current type	Arc time	Energy	Dep. rate	Weight/ 1000 pcs (kg)	Electrodes/ kg weldmetal	kg electrodes/ kg weldmetal
			- per electrode at max. current - (S)*	E(kJ)	H(kg/h)		B	1/N
2.5 x 350	40-90	DC+	46	82	0.98	20.3	80	1.64
3.2 x 350	70-110	DC+	52	137	1.4	32.1	48	1.54
4.0 x 350	90-140	DC+	61	212	1.9	48.6	31	1.49

*Stub end 35mm

WELDING PARAMETERS, OPTIMUM FILL PASSES

Diameter (mm)	Welding positions					
	PA/1G	PB/2F	PC/2G	PF/3Gup	PE/4G	PH/5Gup
2.5	70A	70A	70A	60A		
3.2	100A	100A	100A	70A	60A	60A
4.0	140A	140A	140A	80A	70A	70A

Jungo® 4465

EMR
SAHARA®

SMAW

CLASSIFICATION

AWS A5.4 E310Mo-15* **A-Nr** 9 **Mat-Nr** 1.4465
ISO 3581-A E 25 22 2 N L B 2 2* **F-Nr** 5
 *:Deviation,see remarks **9606 FM** 5

TEMPERATURE RANGE

Pressurized parts : -40...+400°C
Oxidation resistance : n.a

GENERAL DESCRIPTION

A basic high CrNiMo-alloyed fully austenitic all position electrode
 Excellent corrosion resistance in strong oxidizing and slightly reducing media
 Especially developed for urea and nitric acid plants
 High resistance to intergranular corrosion
 Excellent performance in the Huey-test
 Weldable on DC+ polarity

WELDING POSITIONS (ISO/ASME)



PA/1G



PB/2F



PC/2G



PF/3Gu



PE/4G



PH/5Gu

CURRENT TYPE

DC +

APPROVALS

TÜV

+

CHEMICAL COMPOSITION (W%), TYPICAL, ALL WELD METAL

C	Mn	Si	Cr	Ni	Mo	N	FN (acc.WRC 1992)
0.03	4.5	0.4	25.0	22.0	2.2	0.13	0

MECHANICAL PROPERTIES, TYPICAL, ALL WELD METAL

Condition	0.2% Proof strength (N/mm ²)	Tensile strength (N/mm ²)	Elongation (%)	Impact ISO-V(J)	
				+20°C	-196°C
Required: AWS A5.4 ISO 3581-A	not required	min. 550 min. 510	min. 30 min. 25	not required	not required
Typical values AW	400	620	35	90	50

PACKAGING AND AVAILABLE SIZES

Carton + PE foil	Diameter (mm)	2.5	3.2	4.0
	Length (mm)	350	350	350
Pieces / unit		135	150	100
	Net weight/unit (kg)	2.8	4.8	4.9

Identification Imprint: JUNG0 4465

Tip Color: yellow

Jungo® 4465: rev. C-EN24-01/02/16

All information in this data sheet is accurate to the best of our knowledge at the time of printing. Please refer to www.lincolnelectric.eu for any updated information.
 Fumes: Safety Data Sheets (SDS) are available on our website.

Jungo® 4465

SMAW

EXAMPLES OF MATERIALS TO BE WELDED

Steel grades	EN 10088-1/-2	Mat. Nr	ASTM / ACl A240/A312/A351	UNS
Fully austenitic CrNiMo corrosion resistant steels				
	X1CrNiMoN25-25-2	1.4465		
	X3CrNiMoTi25-25	1.4577		
	X2CrNi19-11	1.4306	(TP)304L CF-3	S30403 J92500
	X2CrNiN18-10	1.4311	(TP)304LN 310S	S30453 S31008

Also very well applicable for build-up welding on low alloy steel, such as pipe plates
Buffer layers for applications from -196°C to +350°C

CALCULATION DATA

Sizes		Current type	Arc time - per electrode at max. current - [S]*	Energy E(kJ)	Dep. rate H(kg/h)	Weight/ 1000 pcs (kg)	Electrodes/ kg weldmetal B	kg electrodes/ kg weldmetal 1/N
Diam. x length (mm)	Current range (A)							
2.5 x 350	50 - 75	DC+	50	86	0.82	21.5	88	1.89
3.2 x 350	70 - 105	DC+	51	135	1.3	32.5	53	1.72
4.0 x 350	100 - 135	DC+	66	206	1.7	48.5	32	1.56

*Stub end 35mm

WELDING PARAMETERS, OPTIMUM FILL PASSES

Diameter (mm)	Welding positions					
	PA/1G	PB/2F	PC/2G	PF/3Gup	PE/4G	PH/5Gup
2.5	60A	60A	60A	60A	60A	60A
3.2	95A	90A	90A	75A	75A	75A
4.0	125A	110A	125A	100A	100A	100A

REMARKS / APPLICATION ADVICE

Deviations: chemical composition:

Cr = 24.5 - 26.0%

AWS: Cr = 25.0 - 28.0%

Ni = 21.5 - 22.5%

AWS: Ni = 20.0 - 22.0%

Mn = 4.5 - 5.3%

AWS: Mn = 1.0 - 2.5%

EN: Mn = 1.0 - 5.0%

Welding with Heat-Input max. 1.5 kJ/mm

Interpass temperature max. 150°C

Jungo® 4500

CLASSIFICATION

AWS A5.4	E385-16*	A-Nr	9	Mat-Nr	1.4519
ISO 3581-A	E 20 25 5 Cu N L R 12	F-Nr	5		
	*:Deviation,see remarks	9606 FM	5		

TEMPERATURE RANGE

Pressurized parts: -60...+400°C
Oxidation resistance: n.a

GENERAL DESCRIPTION

A rutile-basic fully austenitic all position electrode

Smooth bead appearance

Easy slag release

Especially developed for applications in phosphoric acid and sulphuric acid and paper mill equipment

Designed for welding alloy 904L

World wide reputation for reliability

Weldable on DC+ polarity

WELDING POSITIONS (ISO/ASME)



PA/1G



PB/2F



PC/2G



PF/3Gu



PE/4G



PH/5Gu

CURRENT TYPE

DC +

APPROVALS

TÜV

+

CHEMICAL COMPOSITION (W%), TYPICAL, ALL WELD METAL

C	Mn	Si	Cr	Ni	Mo	Cu	FN (acc.WRC 1992)
0.02	1.2	0.9	20.0	25.0	5.0	1.5	0

MECHANICAL PROPERTIES, TYPICAL, ALL WELD METAL

Condition	0.2% Proof strength [N/mm ²]	Tensile strength [N/mm ²]	Elongation [%]	Impact ISO-V[J]		
				+20°C	-40°C	-60°C
Required: AWS A5.4 ISO 3581-A Typical values	not required min. 320 410	min. 520 min. 510 620	min. 30 min. 25 40	not required not required 100	80	50

PACKAGING AND AVAILABLE SIZES

Carton + PE foil	Diameter (mm)	2.5	3.2	4.0
	Length (mm)	350	350	350
Pieces / unit	Pieces / unit	145	185	125
	Net weight/unit (kg)	2.9	5.7	5.9

Identification Imprint: JUNGO 4500

Tip Color: black

Jungo® 4500: rev. C-EN25-01/02/16

All information in this data sheet is accurate to the best of our knowledge at the time of printing. Please refer to www.lincolnelectric.eu for any updated information.
Fumes: Safety Data Sheets (SDS) are available on our website.

Jungo[®] 4500

EXAMPLES OF MATERIALS TO BE WELDED

Steel grades	EN 10088-1/-2	EN 10213-4	Mat. Nr
Fully austenitic NiCrMoCu and CrNiMoCu steels			
	X5NiCrMoCuTi20-18	GX7NiCrMoCuNb25-20	1.4500
			1.4506
		GX2NiCrMoCuN20-18	1.4531
		GX2NiCrMoCuN25-20	1.4536
	X1NiCrMoCu25-20-5	(Alloy 904L)	1.4539
		GX7CrNiMoCuNb18-18	1.4585
	X5NiCrMoCuNb22-18		1.4586

SMAW

CALCULATION DATA

Sizes Diam. x length (mm)	Current range (A)	Current type	Arc time	Energy	Dep. rate	Weight/ 1000 pcs (kg)	Electrodes/ kg weldmetal B	kg electrodes/ kg weldmetal 1/N
			- per electrode at max. current - (S)*	E(kJ)	H(kg/h)			
2.5 x 350	40 - 75	DC+	43	72	0.96	19.9	79	1.59
3.2 x 350	60 - 105	DC+	53	133	1.3	32.1	52	1.69
4.0 x 350	80 - 145	DC+	61	220	1.8	48.0	32	1.56

*Stub end 35mm

WELDING PARAMETERS, OPTIMUM FILL PASSES

Diameter (mm)	Welding positions					
	PA/1G	PB/2F	PC/2G	PF/3Gup	PE/4G	PH/5Gup
2.5	70A	70A	70A	60A	80A	60A
3.2	100A	100A	100A	70A	70A	70A
4.0	140A	140A	140A	80A		

REMARKS / APPLICATION ADVICE

Deviations: chemical composition:

Si = max. 1.0%

AWS: Si = max. 0.9%

Welding with Heat-Input max. 1.5 kJ/mm

Interpass temperature max. 150°C

Arosta® 4462

EMR
SAHARA®

SMAW

CLASSIFICATION

AWS A5.4	E2209-16*	A-Nr	8	Mat-Nr	1.4462
ISO 3581-A	E 22 9 3 N L R 3 2	F-Nr	5		
		9606 FM	5		

TEMPERATURE RANGE

Pressurized parts :-40...+250°C
Oxidation resistance : n.a

GENERAL DESCRIPTION

A rutile-basic all position electrode for duplex stainless steel welding
Excellent weldability for filling as well as for root runs
Applicable up to a service temperature of 250°C
High resistance to general corrosion, pitting and stress corrosion (PREN ~35)
High yield strength > 500 N/mm²
Weldable on AC and DC
Also available in vacuum sealed Sahara ReadyPack® (SRP)

WELDING POSITIONS (ISO/ASME)



PA/1G



PB/2F



PC/2G



PF/3Gu



PE/4G



PH/5Gu

CURRENT TYPE

AC/DC +/-

APPROVALS

BV	DNV	GL	RINA	TÜV
2209	+	4462	2209	+

CHEMICAL COMPOSITION (W%), TYPICAL, ALL WELD METAL

C	Mn	Si	Cr	Ni	Mo	N	FN (acc.WRC 1992)
0.02	0.8	1.0	22.5	9.5	3.2	0.16	30-55

MECHANICAL PROPERTIES, TYPICAL, ALL WELD METAL

Condition	0.2% Proof strength (N/mm ²)	Tensile strength (N/mm ²)	Elongation (%)	Impact ISO-V(J)		
				+20°C	-30°C	-40°C
Required: AWS A5.4 ISO 3581-A Typical values	not required min. 450 650	min. 690 min. 550 800	min. 20 min. 20 27	not required not required 60	- 50	- 40

PACKAGING AND AVAILABLE SIZES

	Diameter (mm) Length (mm)	2.5	3.2	4.0	5.0
		350	350	350	350
Carton + PE foil	Pieces / unit	120	152	95	-
	Net weight/unit (kg)	2.6	5.0	4.8	-
SRP	Pieces / unit	69	52	29	24
	Net weight/unit (kg)	1.5	1.8	1.6	2.0

Identification Imprint: 2209-16 / AROSTA 4462 Tip Color: white

Arosta® 4462: rev. C-EN26-01/02/16

All information in this data sheet is accurate to the best of our knowledge at the time of printing. Please refer to www.lincolnelectric.eu for any updated information.
Fumes: Safety Data Sheets (SDS) are available on our website.

Arosta® 4462

SMAW

EXAMPLES OF MATERIALS TO BE WELDED

Steel grades	EN 10088-1/-2/-4	Mat. Nr	ASTM / ACI A240	UNS
Duplex stainless steels	X2CrNiMoN22-5-3	1.4462		S31803
		1.4417		S31500
	X3CrNiMoN27-5-2	1.4460		S31200
	X2CrNiN23-4	1.4362		S32304
	X2CrMnNi21-5-1	1.4162		S32101

Dissimilar joints such as un- and low alloy steel to duplex stainless steel

CALCULATION DATA

Sizes Diam. x length (mm)	Current range (A)	Current type	Arc time	Energy	Dep. rate	Weight/ 1000 pcs (kg)	Electrodes/ kg weldmetal B	kg electrodes/ kg weldmetal 1/N
			- per electrode at max. current - (S)*	E(kJ)	H(kg/h)			
2.5 x 350	40 - 75	DC+	61	127	0.73	20.6	81	1.67
3.2 x 350	80 - 110	DC+	56	184	1.4	34.3	46	1.59
4.0 x 350	80 - 150	DC+	59	205	2.0	51.5	30	1.52
5.0 x 350	140 - 220		65	357	2.8	77.4	20	1.61

*Stub end 35mm

WELDING PARAMETERS, OPTIMUM FILL PASSES

Diameter (mm)	Welding positions					
	PA/1G	PB/2F	PC/2G	PF/3Gup	PE/4G	PH/5Gup
2.5	70A	70A	70A	60A	80A	60A
3.2	100A	100A	100A	70A	70A	70A
4.0	140A	140A	140A	80A		
5.0	180A	180A	180A			

REMARKS / APPLICATION ADVICE

Welding with Heat-Input max. 2.5 kJ/mm
 Interpass temperature max. 150°C
 Deviations chemical composition:
 Si = 0,4-1,2 AWS = max 1,00

Jungo® 4462

SMAW

CLASSIFICATION

AWS A5.4	E2209-15	A-Nr	8	Mat-Nr	1.4462
ISO 3581-A	E 22 9 3 N L B 2 2	F-Nr	5		
		9606 FM	5		

TEMPERATURE RANGE

Pressurized parts: -50...+250°C
Oxidation resistance: n.a

GENERAL DESCRIPTION

A basic electrode for 22% Cr duplex stainless steel welding
Excellent weldability for filling as well as for root runs
Applicable up to a service temperature of 250°C
High resistance to general corrosion, pitting and stress corrosion (PREN ~35)
High yield strength > 500 N/mm²
Weldable on DC+ polarity
Also available in vacuum sealed Sahara ReadyPack® (SRP)

WELDING POSITIONS (ISO/ASME)



PA/1G



PB/2F



PC/2G



PF/3Gu



PE/4G



PH/5Gu

CURRENT TYPE

DC +

APPROVALS

DNV

+

CHEMICAL COMPOSITION (W%), TYPICAL, ALL WELD METAL

C	Mn	Si	Cr	Ni	Mo	N	FN (acc.WRC 1992)
0.025	1.6	0.5	23.5	9.0	3.0	0.15	30-60

MECHANICAL PROPERTIES, TYPICAL, ALL WELD METAL

Condition	0.2% Proof strength (N/mm ²)	Tensile strength (N/mm ²)	Elongation (%)	Impact ISO-V(J)				
				+20°C	-20°C	-40°C	-50°C	
Required: AWS A5.4 ISO 3581-A Typical values	not required min. 450 650	min. 690 min. 550 800	min. 20 min. 20 28	not required not required 80		75	70	45
AW								

PACKAGING AND AVAILABLE SIZES

SRP	Diameter (mm)	2.5	3.2	4.0
	Length (mm)	350	350	350
Pieces / unit	69	55	30	
Net weight/unit (kg)	1.4	1.8	1.5	

Identification Imprint: 2209-15 / JUNG0 4462 Tip Color: red

Jungo® 4462: rev. C-EN26-01/02/16

All information in this data sheet is accurate to the best of our knowledge at the time of printing. Please refer to www.lincolnelectric.eu for any updated information.
Fumes: Safety Data Sheets (SDS) are available on our website.

Jungo[®] 4462

EXAMPLES OF MATERIALS TO BE WELDED

Steel grades	EN 10088-1/-2/-4	Mat. Nr	ASTM / ACI A240	UNS
Duplex stainless steels	X2CrNiMoN22 -5-3	1.4462		S31803
		1.4417		S31500
	X3CrNiMoN27-5-2	1.4460		S31200
	X2CrNiN23-4	1.4362		S32304
	X2CrMnNi21-5-1	1.4162		S32101

Dissimilar joints such as un- and low alloy steel to duplex stainless steel

CALCULATION DATA

Sizes		Current range (A)	Current type	Arc time	Energy	Dep. rate	Weight/ 1000 pcs (kg)	Electrodes/ kg weldmetal B	kg electrodes/ kg weldmetal 1/N
Diam. x length (mm)	- per electrode at max. current - (S)*			E(kJ)	H(kg/h)				
2.5 x 350	74	50-80	DC+	74	101	0.62	21.0	78	1.64
3.2 x 350	84	70-110	DC+	84	219	0.88	33.8	49	1.64
4.0 x 350	80	100-140	DC+	80	304	1.4	50.8	32	1.61

*Stub end 35mm

WELDING PARAMETERS, OPTIMUM FILL PASSES

Diameter (mm)	Welding positions					
	PA/1G	PB/2F	PC/2G	PF/3Gup	PE/4G	PH/5Gup
2.5	60A	60A	60A	60A	60A	60A
3.2	85A	80A	90A	80A	80A	80A
4.0	120A					

REMARKS / APPLICATION ADVICE

Interpass temperature depends on construction (max. 150°C)

Jungo® 309L

CLASSIFICATION

AWS A5.4	E309L-16	A-Nr	8	Mat-Nr	1.4332
ISO 3581-A	E 23 12 L B 2 2	F-Nr	5		
		9606 FM	5		

TEMPERATURE RANGE

Pressurized parts : -196...+300°C
Oxidation resistance : n.a

GENERAL DESCRIPTION

A basic high CrNi alloyed buffer electrode
For welding stainless steel to mild steel and root passes in clad steel
Applicable for root passes in N alloyed AISI 304LN steels
Outstanding mechanical properties
High resistance to embrittlement
Weldable on AC and DC+ polarity

WELDING POSITIONS (ISO/ASME)



PA/1G



PB/2F



PC/2G



PF/3Gu



PE/4G



PH/5Gu

CURRENT TYPE

AC/DC +

CHEMICAL COMPOSITION (W%), TYPICAL, ALL WELD METAL

C	Mn	Si	Cr	Ni	FN (acc.WRC 1992)
0.025	1.5	0.4	23.0	13.0	10-20

MECHANICAL PROPERTIES, TYPICAL, ALL WELD METAL

Condition	0.2% Proof strength (N/mm ²)	Tensile strength (N/mm ²)	Elongation (%)	Impact ISO-V(J) -196°C
Required: AWS A5.4 ISO 3581-A Typical values	not required min. 320 470	min. 520 min. 510 570	min. 30 min. 25 40	40
AW				

PACKAGING AND AVAILABLE SIZES

Carton + PE foil	Diameter (mm)	2.5	4.0	5.0
	Length (mm)	350	350	350
Pieces / unit		117	97	60
	Net weight/unit (kg)	2.4	4.8	4.8

Identification Imprint: 309L-15 / JUNGO 309 L

Tip Color:

Jungo® 309L rev. C-EN07-01/02/16

All information in this data sheet is accurate to the best of our knowledge at the time of printing. Please refer to www.lincolnelectric.eu for any updated information.
Fumes: Safety Data Sheets (SDS) are available on our website.

Jungo® 309L

EXAMPLES OF MATERIALS TO BE WELDED

Steel grades	EN 10088-1/-2	Mat. Nr	ASTM/ACI A240/A312/A351	UNS
Corrosion resistant cladsteels				
	X2CrNiN18-10	1.4311	(TP)304LN	S30453
	X2CrNi19-11	1.4306	(TP)304L	S30403
			CF-3	J92500
	X4CrNi18-10	1.4301	(TP)304	S30400

Dissimilar metals (mild and low alloy steel to CrNi or CrNiMo stainless steel)

Build-up welding on mild and low alloy steel

Buffer layer CrNi-cladsteel

CALCULATION DATA

Sizes Diam. x length [mm]	Current range [A]	Current type	Arc time	Energy	Dep. rate	Weight/ 1000 pcs [kg]	Electrodes/ kg weldmetal B	kg electrodes/ kg weldmetal 1/N
			- per electrode at max. current - [S]*	E[kJ]	H[kg/h]			
2.5 x 350	40-75	DC+	50	88	0.93	21.0	77	1.61
4.0 x 350	80-150	DC+	64	241	1.8	48.3	31	1.49

*Stub end 35mm

WELDING PARAMETERS, OPTIMUM FILL PASSES

Diameter [mm]	Welding positions					
	PA/1G	PB/2F	PC/2G	PF/3Gup	PE/4G	PH/5Gup
2.5	70A	70A	70A	60A80A	60A	60A
4.0	140A	140A	140A			

Arosta® 309S

EMR SAHARA®

SMAW

CLASSIFICATION

AWS A5.4	E309L-16	A-Nr	8	Mat-Nr	1.4332
ISO 3581-A	E 23 12 L R 3 2	F-Nr	5		
		9606 FM	5		

TEMPERATURE RANGE

Pressurized parts : -120...+300°C
Oxidation resistance : n.a

GENERAL DESCRIPTION

A rutile-basic high CrNi alloyed buffer electrode
For welding stainless steel to mild steel and root runs in clad steel
Applicable for root passes in N alloyed AISI 304LN steels
Excellent weldability and self releasing slag
High resistance to embrittlement
Weldable on AC and DC+ polarity
Also available in vacuum sealed Sahara ReadyPack® [SRP]

WELDING POSITIONS (ISO/ASME)



CURRENT TYPE

AC/DC +

APPROVALS

ABS	BV	RMRS	TÜV
+	309L	SS/CMn	+

CHEMICAL COMPOSITION (W%), TYPICAL, ALL WELD METAL

C	Mn	Si	Cr	Ni	FN (acc.WRC 1992)
0.02	0.8	0.8	23.5	12.5	12-20

MECHANICAL PROPERTIES, TYPICAL, ALL WELD METAL

Condition	0.2% Proof strength (N/mm²)	Tensile strength (N/mm²)	Elongation (%)	Impact ISO-V(J)		
				+20°C	-20°C	-120°C
Required: AWS A5.4 ISO 3581-A Typical values	not required min. 320 480	min. 520 min. 510 560	min. 30 min. 25 40	not required not required 60	50	40

PACKAGING AND AVAILABLE SIZES

	Diameter (mm) Length (mm)	2.5	3.2	4.0	5.0
		350	350	350	350
Carton + PE foil	Pieces / unit	135	150	100	65
	Net weight/unit (kg)	2.8	5.0	5.0	5.0
SRP	Pieces / unit	69	56	-	-
	Net weight/unit (kg)	1.4	1.9	-	-

Identification Imprint: 309L-16 / AROSTA 309 S Tip Color: sea green

Arosta®309S: rev. C-EN25-01/02/16

All information in this data sheet is accurate to the best of our knowledge at the time of printing. Please refer to www.lincolnelectric.eu for any updated information.
Fumes: Safety Data Sheets (SDS) are available on our website.

Arosta® 309S

EXAMPLES OF MATERIALS TO BE WELDED

Steel grades	EN 10088-1/-2	Mat. Nr	ASTM/ACI A240/A312/A351	UNS
Corrosion resistant cladsteels				
	X2CrNi18-10	1.4311	(TP)304LN	S30453
	X2CrNi19-11	1.4306	(TP)304L	S30403
			CF-3	J92500
	X4CrNi18-10	1.4301	(TP)304	S30400

Dissimilar metals (mild and low alloy steel to CrNi or CrNiMo stainless steel)

Build-up welding on mild and low alloy steel

Bufferlayer CrNi-cladsteel

SMAW

CALCULATION DATA

Sizes Diam. x length (mm)	Current range (A)	Current type	Arc time	Energy	Dep. rate	Weight/ 1000 pcs (kg)	Electrodes/ kg weldmetal B	kg electrodes/ kg weldmetal 1/N
			- per electrode at max. current - (S)*	E(kJ)	H(kg/h)			
2.5 x 350	40 - 75	DC+	50	88	0.93	21.0	77	1.61
3.2 x 350	60 - 110	DC+	58	160	1.3	32.5	46	1.49
4.0 x 350	80 - 150	DC+	64	241	1.8	48.3	31	1.49
5.0 x 350	140 - 220	DC+	68	372	2.8	78.0	19	1.49

*Stub end 35mm

WELDING PARAMETERS, OPTIMUM FILL PASSES

Diameter (mm)	Welding positions					
	PA/1G	PB/2F	PC/2G	PF/3Gup	PE/4G	PH/5Gup
2.5	70A	70A	70A	60A	60A	60A
3.2	100A	100A	100A	70A	70A	70A
4.0	140A	140A	140A	80A		
5.0	180A	180A	180A			

Limarosta® 309S

EMR
SAHARA®

SMAW

CLASSIFICATION

AWS A5.4	E309L-17	A-Nr	8	Mat-Nr	1.4332
ISO 3581-A	E 23 12 L R 3 2	F-Nr	5		
		9606 FM	5		

TEMPERATURE RANGE

Pressurized parts : -20...+300°C
Oxidation resistance : n.a

GENERAL DESCRIPTION

A rutile-basic all position CrNi over-alloyed buffer electrode
Developed for welding stainless steel to mild steel and for clad steel
Self releasing slag
Excellent side wall wetting, no undercut, mirror like bead appearance
High resistance to porosity
Weldable on AC and DC+ polarity
Also available in vacuum sealed Sahara ReadyPack® [SRP]

WELDING POSITIONS (ISO/ASME)

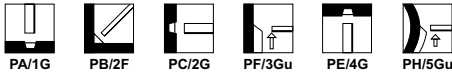

CURRENT TYPE

AC/DC +

APPROVALS

DNV	GL	LR	RMRS	TÜV
309L	4432	SS/CMn	SS/CMn	+

CHEMICAL COMPOSITION (W%), TYPICAL, ALL WELD METAL

C	Mn	Si	Cr	Ni	FN (acc.WRC 1992)
0.02	0.8	1.0	23.0	12.5	10-20

MECHANICAL PROPERTIES, TYPICAL, ALL WELD METAL

Condition	0.2% Proof strength (N/mm²)	Tensile strength (N/mm²)	Elongation (%)	Impact ISO-V(J)	
				+20°C	-20°C
Required: AWS A5.4 ISO 3581-A Typical values	not required min. 320 480	min. 520 min. 510 560	min. 30 min. 25 40	not required not required 55	- 50

PACKAGING AND AVAILABLE SIZES

	Diameter (mm)	2.0	2.5	3.2	4.0	5.0
	Length (mm)	300	350	350	450	450
Carton + PE foil	Pieces / unit	200	125	135	85	55
	Net weight/unit (kg)	2.3	2.8	4.9	5.9	6.0
SRP	Pieces / unit	-	65	50	28	-
	Net weight/unit (kg)	-	1.5	1.8	2.0	-
Linc Can™	Pieces / unit	-	197	127	79	-
	Net weight/unit (kg)	-	4.4	4.5	5.4	-

Identification Imprint: 309L-17 / LIMAROSTA 309 S Tip Color: sea green

Limarosta 309S: rev. C-EN25-01/02/16

All information in this data sheet is accurate to the best of our knowledge at the time of printing. Please refer to www.lincolnelectric.eu for any updated information.
Fumes: Safety Data Sheets (SDS) are available on our website.

Limarosta® 309S

EXAMPLES OF MATERIALS TO BE WELDED

Steel grades	EN 10088-1/-2	Mat. Nr	ASTM/ACI A240/A312/A351	UNS
Corrosion resistant cladsteels				
	X2CrNiN18-10	1.4311	(TP)304LN	S30453
	X2CrNi19-11	1.4306	(TP)304L	S30403
			CF-3	J92500
	X4CrNi18-10	1.4301	(TP)304	S30400

Dissimilar metals (mild and low alloy steel to CrNi or CrNiMo stainless steel)

Build-up welding on mild and low alloy steel

Bufferlayer CrNi-cladsteel

SMAW

CALCULATION DATA

Sizes		Current range (A)	Current type	Arc time	Energy	Dep. rate	Weight/ 1000 pcs (kg)	Electrodes/ kg weldmetal B	kg electrodes/ kg weldmetal 1/N
Diam. x length (mm)	- per electrode at max. current - (S)*			E(kJ)	H(kg/h)				
2.0 x 300	35-55	DC+	38	49	0.66	11.3	142	1.59	
2.5 x 350	45-80	DC+	48	95	0.99	22.1	77	1.69	
3.2 x 350	80-115	DC+	56	160	1.4	35.1	46	1.59	
4.0 x 350	100-155	DC+	76	317	2.0	69.9	23	1.64	
5.0 x 350	150-220	DC+	84	575	2.9	108.0	15	1.59	

*Stub end 35mm

WELDING PARAMETERS, OPTIMUM FILL PASSES

Diameter (mm)	Welding positions					
	PA/1G	PB/2F	PC/2G	PF/3Gup	PE/4G	PH/5Gup
2.0		45A	45A	40A	40A	40A
2.5	70A	70A	70A	60A	60A	60A
3.2	100A	100A	100A	70A	70A	70A
4.0	140A	140A	140A			
5.0	180A	180A				

Arosta® 309Mo

EMR
SAHARA®

SMAW

CLASSIFICATION

AWS A5.4	E309LMo-16	A-Nr	8	Mat-Nr	1.4459
ISO 3581-A	E 23 12 2 L R 3 2	F-Nr	5		
		9606 FM	5		

TEMPERATURE RANGE

Pressurized parts: -60...+300°C
Oxidation resistance: n.a

GENERAL DESCRIPTION

A high CrNiMo alloyed all position rutile-basic electrode
High corrosion resistance
Specially developed for welding stainless steel to mild steel and root runs in cladding
max. plate thickness in butt welds ~ 12mm
Suitable for repair welding in dissimilar joints and steels difficult to weld
Weldable on AC and DC+ polarity

WELDING POSITIONS (ISO/ASME)



CURRENT TYPE

AC/DC +

APPROVALS

ABS	BV	DNV	GL	LR	RINA	RMRS	TÜV	DB
+	309Mo	309Mo	4459	SS/CMn	309Mo	SS/CMn	+	+

CHEMICAL COMPOSITION (W%), TYPICAL, ALL WELD METAL

C	Mn	Si	Cr	Ni	Mo	FN (acc.WRC 1992)
0.02	0.8	0.8	23.0	12.5	2.7	15-25

MECHANICAL PROPERTIES, TYPICAL, ALL WELD METAL

Condition	0.2% Proof strength [N/mm²]	Tensile strength [N/mm²]	Elongation [%]	Impact ISO-V[J]		
				+20°C	-20°C	-60°C
Required: AWS A5.4 ISO 3581-A Typical values	not required min. 350 580	min. 520 min. 550 700	min. 30 min. 25 30	not required not required 57	50	45

PACKAGING AND AVAILABLE SIZES

Carton + PE foil	Diameter (mm)	2.0	2.5	3.2	4.0	5.0
	Length (mm)	300	350	350	350	450
Pieces / unit	Pieces / unit	180	110	120	85	55
	Net weight/unit (kg)	2.4	2.6	4.7	4.8	5.4

Identification Imprint: 309LMo-16 / AROSTA 309 Mo Tip Color: light blue

Arosta® 309Mo: rev. C-EN23-01/02/16-01/02/16

All information in this data sheet is accurate to the best of our knowledge at the time of printing. Please refer to www.lincolnelectric.eu for any updated information.
Fumes: Safety Data Sheets (SDS) are available on our website.

Arosta® 309Mo

EXAMPLES OF MATERIALS TO BE WELDED

Steel grades	EN 10088-1/-2	EN 10213-4	Mat. Nr	ASTM/ACI A240/A312/A351	UNS
First layer in CrNiMo claddings					
	X2CrNiMo17-12-2		1.4404	(TP)316L CF-3M	S31603 J92800
	X2CrNiMo18-14-3		1.4435	(TP)316L	S31603
	X2CrNiMoN17-11-2		1.4406	(TP)316LN	S31653
	X2CrNiMoN17-13-3		1.4429		
	X4CrNiMo17-12-2		1.4401	(TP)316	S31600
	X4CrNiMo17-13-3		1.4436		
	X6CrNiMoTi17-12-2		1.4571	316Ti	S31635
	X10CrNiMoTi17-3		1.4573	316Ti	S31635
	X6CrNiMoNb17-12-2		1.4580	316Cb	S31640
		GX5CrNiMo19-11	1.4408		

Welding dissimilar metals: mild steel or low alloy steel to stainless CrNiMo-steel up to max. thickness of 12 mm.

Build-up welding on mild and low alloy steel

CALCULATION DATA

Sizes Diam. x length (mm)	Current range (A)	Current type	Arc time	Energy	Dep. rate	Weight/ 1000 pcs (kg)	Electrodes/ kg weldmetal B	kg electrodes/ kg weldmetal 1/N
			- per electrode at max. current - (S)*	E(kJ)	H(kg/h)			
2.0 x 300	30 - 60	DC+	44	46	0.54	10.8	149	1.61
2.5 x 350	40 - 80	DC+	52	90	0.91	20.4	76	1.54
3.2 x 350	60 - 80	DC+	58	122	1.4	33.2	45	1.49
4.0 x 350	80 - 150	DC+	64	259	1.9	51.6	30	1.54
5.0 x 450	140 - 190	DC+	99	549	2.6	98.7	14	1.38

*Stub end 35mm

WELDING PARAMETERS, OPTIMUM FILL PASSES

Diameter (mm)	Welding positions					
	PA/1G	PB/2F	PC/2G	PF/3Gup	PE/4G	PH/5Gup
2.0		45A	45A	40A	40A	40A
2.5	70A	70A	70A	60A	60A	60A
3.2	100A	100A	100A	70A	70A	70A
4.0	140A	140A	140A	80A		
5.0	180A	180A	180A			

SMAW

CLASSIFICATION

AWS A5.4	E308LMo-16	A-Nr	8	Mat-Nr	1.4431
ISO 3581-A	E 20 10 3 R 3 2	F-Nr	5		
		9606 FM	5		

TEMPERATURE RANGE

Pressurized parts : -20...+300°C
Oxidation resistance : n.a

GENERAL DESCRIPTION

A rutile-basic all position electrode for welding dissimilar joints
The general purpose electrode for repair welding
Suitable for hobby and professional applications
Easy slag release and smooth bead appearance
Also applicable for joining steels difficult to weld
Weldable on AC and DC+ polarity

WELDING POSITIONS (ISO/ASME)



PA/1G



PB/2F



PC/2G



PF/3Gu



PE/4G



PH/5Gu

CURRENT TYPE

AC/DC +

APPROVALS

BV	DNV	GL	TÜV	DB
UP	308Mo	4431	+	+

CHEMICAL COMPOSITION (W%), TYPICAL, ALL WELD METAL

C	Mn	Si	Cr	Ni	Mo	FN (acc.WRC 1992)
0.025	0.8	1.0	20.0	9.5	2.3	20

MECHANICAL PROPERTIES, TYPICAL, ALL WELD METAL

Condition	0.2% Proof strength (N/mm ²)	Tensile strength (N/mm ²)	Elongation (%)	Impact ISO-V(J)	
				+20°C	-20°C
Required: AWS A5.4 ISO 3581-A Typical values	not required min. 400 500	min. 520 min. 620 720	min. 35 min. 20 30	not required not required 70	
AW					60

PACKAGING AND AVAILABLE SIZES

Carton + PE foil	Diameter (mm)	2.5	3.2	4.0
	Length (mm)	350	350	350
Pieces / unit		135	150	100
	Net weight/unit (kg)	2.7	4.9	5.0

Identification Imprint: 308LMo-16 / NICHROMA Tip Color: purple

Nichroma: rev. C-ENZ-01/02/16

All information in this data sheet is accurate to the best of our knowledge at the time of printing. Please refer to www.lincolnelectric.eu for any updated information.
Fumes: Safety Data Sheets (SDS) are available on our website.

Nichroma

EXAMPLES OF MATERIALS TO BE WELDED

Steel grades	EN 10088-1/-2	EN 10213-4	Mat. Nr	ASTM/ACI A240/A312/A351	UNS
First layer in CrNiMo claddings					
	X2CrNiMo17-12-2		1.4404	(TP)316L CF-3M	S31603 J92800
	X2CrNiMo18-14-3		1.4435	(TP)316L	S31603
	X2CrNiMoN17-11-2		1.4406	(TP)316LN	S31653
	X2CrNiMoN17-13-3		1.4429		
	X4CrNiMo17-12-2		1.4401	(TP)316	S31600
	X4CrNiMo17-13-3		1.4436		
	X6CrNiMoTi17-12-2		1.4571	316Ti	S31635
	X10CrNiMoTi17-3		1.4573	316Ti	S31635
	X6CrNiMoNb17-12-2		1.4580	316Cb	S31640
		GX5CrNiMo19-11	1.4408		

Welding dissimilar metals: mild steel and low alloy steel to stainless CrNi and CrNiMo-steel

Build-up welding on mild and low alloy steel

CALCULATION DATA

Sizes Diam. x length (mm)	Current range (A)	Current type	Arc time	Energy	Dep. rate	Weight/ 1000 pcs (kg)	Electrodes/ kg weldmetal B	kg electrodes/ kg weldmetal 1/N
			- per electrode at max. current - (S)*	E(kJ)	H(kg/h)			
2.5 x 350	40 - 75	DC+	54	99	0.86	19.8	78	1.54
3.2 x 350	60 - 110	DC+	52	132	1.5	33.4	46	1.54
4.0 x 350	80 - 150	DC+	62	234	1.9	49.6	30	1.49
5.0 x 450	140 - 220	DC+	66	365	2.8	78.4	19	1.52

*Stub end 35mm

WELDING PARAMETERS, OPTIMUM FILL PASSES

Diameter (mm)	Welding positions					
	PA/1G	PB/2F	PC/2G	PF/3Gup	PE/4G	PH/5Gup
2.5	70A	70A	70A	60A	60A	60A
3.2	100A	100A	100A	70A	70A	70A
4.0	140A	140A	140A	80A		
5.0	180A	180A	180A			

Nichroma 160

EMR
SAHARA®

SMAW

CLASSIFICATION

AWS A5.4	E309Mo-26	A-Nr	8	Mat-Nr	1.4459
ISO 3581-A	E 23 12 2 LR 53*	F-Nr	5		
*:Deviation,see remarks		9606 FM	5		

TEMPERATURE RANGE

Pressurized parts : -20...+300°C
Oxidation resistance : n.a

GENERAL DESCRIPTION

A rutile-basic synthetic high recovery (160%) electrode for shipbuilding
For welding carbon steel to stainless steel in the down hand position
Excellent for fillet welding
High resistance to porosity on primed plate
Higher welding current Metal can be used
High deposition rates
Smooth bead appearance and easy slag release
Weldable on AC and DC+ polarity

WELDING POSITIONS (ISO/ASME)

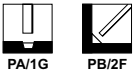

CURRENT TYPE

AC/DC +

APPROVALS

ABS	BV	DNV	GL	RINA	RMRS
+	UP	309Mo	4431	309Mo	SS/CMn

CHEMICAL COMPOSITION (W%), TYPICAL, ALL WELD METAL

C	Mn	Si	Cr	Ni	Mo	FN (acc.WRC 1992)
0.05	0.7	1.0	23.7	12.8	2.4	15

MECHANICAL PROPERTIES, TYPICAL, ALL WELD METAL

Condition	0.2% Proof strength [N/mm ²]	Tensile strength [N/mm ²]	Elongation [%]	Impact ISO-V(J)	
				+20°C	-20°C
Required: AWS A5.4 ISO 3581-A Typical values	not required min. 350 550	min. 550 min. 550 740	min. 30 min. 25 28	not required not required 50	
AW					45

PACKAGING AND AVAILABLE SIZES

Carton + PE foil	Diameter (mm)	3.2	4.0
	Length (mm)	450	450
Pieces / unit	Net weight/unit (kg)	90	55
		6.1	5.9

Identification Imprint: 309Mo-26 / NICHROMA 160 Tip Color: sea green

Nichroma 160: rev. C-EN25-01/02/16

All information in this data sheet is accurate to the best of our knowledge at the time of printing. Please refer to www.lincolnelectric.eu for any updated information.
Fumes: Safety Data Sheets (SDS) are available on our website.

Nichroma 160

EXAMPLES OF MATERIALS TO BE WELDED

Steel grades	EN 10088-1/-2	EN 10213-4	Mat. Nr	ASTM/ACI A240/A312/A351	UNS
First layer in CrNiMo claddings					
	X2CrNiMo17-12-2		1.4404	(TP)316L	S31603
	CF-3M	J92800			
	X2CrNiMo18-14-3		1.4435	(TP)316L	S31603
	X4CrNiMo17-12-2		1.4401	(TP)316	S31600
	X4CrNiMo17-13-3		1.4436		
	X6CrNiMoTi17-12-2		1.4571	316Ti	S31635
	X10CrNiMoTi17-3		1.4573	316Ti	S31635
	X6CrNiMoNb17-12-2		1.4580	316Cb	S31640
		GX5CrNiMo19-11	1.4408		

Welding dissimilar metals: mild steel or low alloy steel to stainless CrNiMo-steel up to max. thickness of 12 mm.

Build-up welding on mild and low alloy steel

CALCULATION DATA

Sizes Diam. x length (mm)	Current range (A)	Current type	Arc time (s)*	Energy - per electrode at max. current - E(kJ)	Dep. rate H(kg/h)	Weight/ 1000 pcs (kg)	Electrodes/ kg weldmetal B	kg electrodes/ kg weldmetal 1/N
3.2 x 450	140-170	DC+	86	409	1.9	68.1	22	1.52
4.0 x 450	180-230	DC+	80	644	3.0	105.5	15	1.59

*Stub end 35mm

WELDING PARAMETERS, OPTIMUM FILL PASSES

Diameter (mm)	Welding positions	
	PA/1G	PB/2F
3.2	175A	140A
4.0	200A	180A

REMARKS / APPLICATION ADVICE

Deviations: chemical composition

C = max. 0.05%

EN: C = max. 0.04%

Limarosta® 312

EMR SAHARA®

SMAW

CLASSIFICATION

AWS A5.4	E312-17	A-Nr	8	Mat-Nr	1.4337
ISO 3581-A	E 29 9 R 12	F-Nr	5		
		9606 FM	5		

TEMPERATURE RANGE

Pressurized parts : -10...+350°C
Oxidation resistance : n.a

GENERAL DESCRIPTION

A rutile-basic high CrNi-alloyed all position electrode
Excellent for repair welding
Especially developed for steels difficult to weld, such as armour plates, austenitic Mn-steels and high C-steels
Excellent weldability and self releasing slag
Weldable on AC and DC+ polarity
Also available in vacuum sealed Sahara ReadyPack® (SRP)

WELDING POSITIONS (ISO/ASME)

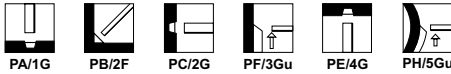

CURRENT TYPE

AC/DC +

APPROVALS

DB

+

CHEMICAL COMPOSITION (W%), TYPICAL, ALL WELD METAL

C	Mn	Si	Cr	Ni
0.11	0.9	1.0	29.0	9.0

MECHANICAL PROPERTIES, TYPICAL, ALL WELD METAL

Condition	0.2% Proof strength [N/mm ²]	Tensile strength [N/mm ²]	Elongation [%]	Impact ISO-V(J) +20°C
Required: AWS 5.4 ISO 3581-A Typical values	not required min. 450 700	min. 660 min. 650 800	min. 22 min. 15 20	not required not required 50
AW				

PACKAGING AND AVAILABLE SIZES

	Diameter (mm)	2.0	2.5	3.2	4.0
	Length (mm)	300	350	350	350
Carton + PE foil	Pieces / unit	175	125	150	100
	Net weight/unit (kg)	2.2	2.6	5.0	5.0
SRP	Pieces / unit	-	69	52	31
	Net weight/unit (kg)	-	1.5	1.8	1.5
Linc Pack	Pieces / unit	-	48	30	-
	Net weight/unit (kg)	-	1.0	1.0	-

Identification Imprint: 312-17 / LIMAROSTA 312 Tip Color: black

Limarosta®312: rev. C-EN26-01/02/16

All information in this data sheet is accurate to the best of our knowledge at the time of printing. Please refer to www.lincolnelectric.eu for any updated information.
Fumes: Safety Data Sheets (SDS) are available on our website.

Limarosta[®] 312

EXAMPLES OF MATERIALS TO BE WELDED

Various steel grades, such as:

- Armour plate
- Hardenable steels including steels difficult to weld
- Non-magnetic austenitic steels
- Work hardening austenitic manganese steels
- Dissimilar steel grades (CMn-steels to stainless steel) up to max. thickness of 12 mm

SMAW

CALCULATION DATA

Sizes		Current type	Arc time - per electrode at max. current - [s]*	Energy E[kJ]	Dep. rate H[kg/h]	Weight/ 1000 pcs [kg]	Electrodes/ kg weldmetal B	kg electrodes/ kg weldmetal 1/N
Diam. x length [mm]	Current range [A]							
2.0 x 300	40-55	DC+	41	45	0.59	12.0	150	1.80
2.5 x 350	50-70	DC+	57	91	0.73	20.7	87	1.79
3.2 x 350	70-100	DC+	60	126	1.1	33.0	52	1.72
4.0 x 350	100-130	DC+	72	273	1.4	49.7	35	1.72

*Stub end 35mm

WELDING PARAMETERS, OPTIMUM FILL PASSES

Diameter [mm]	Welding positions					
	PA/1G	PB/2F	PC/2G	PF/3Gup	PE/4G	PH/5Gup
2.5	70A	70A	70A	60A	60A	60A
3.2	100A	90A	100A	65A	65A	65A
4.0	130A	125A	130A	80A		

Arosta® 307

EMR
SAHARA®

SMAW

CLASSIFICATION

AWS A5.4 E307-16* **A-Nr** 8 **Mat-Nr** 1.4370
ISO 3581-A E 18 8 Mn R 12 **F-Nr** 5
 *:Deviation,see remarks **9606 FM** 5

TEMPERATURE RANGE

Pressurized parts :-60...+350°C
Oxidation resistance : n.a

GENERAL DESCRIPTION

A rutile- basic all position 5%Mn-alloyed stainless steel electrode
 Especially developed for steels difficult to weld, such as armour lates and austenitic high Mn-steels
 Often used as a buffer layer in hardfacing applications
 Weldable on AC and DC+ polarity

WELDING POSITIONS (ISO/ASME)

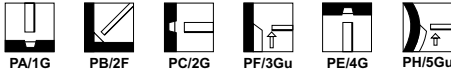

CURRENT TYPE

AC/DC +

APPROVALS

TÜV **DB**
 + +

CHEMICAL COMPOSITION (W%), TYPICAL, ALL WELD METAL

C	Mn	Si	Cr	Ni	FN (acc.WRC 1992)
0.09	5.0	0.6	18.5	8.5	0

MECHANICAL PROPERTIES, TYPICAL, ALL WELD METAL

Condition	0.2% Proof strength [N/mm²]	Tensile strength [N/mm²]	Elongation [%]	Impact ISO-V[J]	
				+20°C	-60°C
Required: AWS A5.4 ISO 3581-A Typical values	not required min. 350 450	min. 590 min. 500 650	min. 30 min. 25 35	not required not required 110	- 75

PACKAGING AND AVAILABLE SIZES

Carton + PE foil	Diameter (mm)	2.5	3.2	4.0
	Length (mm)	350	350	350
Pieces / unit	Net weight/unit (kg)	125	135	85
		2.6	4.7	4.6

Identification Imprint: AROSTA 307

Tip Color: dark blue

Arosta®307: rev. C-EN23-01/02/16

All information in this data sheet is accurate to the best of our knowledge at the time of printing. Please refer to www.lincolnelectric.eu for any updated information.
 Fumes: Safety Data Sheets (SDS) are available on our website.

Arosta[®] 307

EXAMPLES OF MATERIALS TO BE WELDED

Various steel grades, such as:

- Armour plate
- Hardenable steels including steels difficult to weld
- Non-magnetic austenitic steels
- Work hardening austenitic manganese steels
- Dissimilar joints
- Problem steels

CALCULATION DATA

Sizes Diam. x length (mm)	Current range (A)	Current type	Arc time	Energy	Dep. rate	Weight/ 1000 pcs (kg)	Electrodes/ kg weldmetal B	kg electrodes/ kg weldmetal 1/N
			- per electrode at max. current - (S)*	E(kJ)	H(kg/h)			
2.5 x 350	70-80	DC+	52	108	0.74	20.4	94	1.92
3.2 x 350	90-120	DC+	56	148	1.2	34.7	54	1.87
4.0 x 350	110-140	DC+	84	251	1.3	53.6	33	1.77

*Stub end 35mm

WELDING PARAMETERS, OPTIMUM FILL PASSES

Diameter (mm)	Welding positions					
	PA/1G	PB/2F	PC/2G	PF/3Gup	PE/4G	PH/5Gup
2.5	80A	80A	80A	80A	80A	80A
3.2	100A	100A	100A	90A		
4.0	140A	115A	130A	110A		

REMARKS / APPLICATION ADVICE

Deviations: chemical composition

Mn = 4.5 - 6.0%

AWS: Mn = 3.30 - 4.75%

Arosta® 307-160

CLASSIFICATION

AWS A5.4	E307-26*	A-Nr	8	Mat-Nr	1.4370
ISO 3581-A	E 18 8 Mn R 5 3	F-Nr	5		
* Nearest classification, see remarks		9606 FM	5		

GENERAL DESCRIPTION

A rutile 6%Mn-alloyed stainless steel electrode
Especially developed for steels difficult to weld, such as armour lates and austenitic high Mn-steels
Often used as a buffer layer in hardfacing applications
Weldable on DC+ polarity

WELDING POSITIONS (ISO/ASME)



PA/1G



PB/2F

CURRENT TYPE

AC/DC +

CHEMICAL COMPOSITION (W%), TYPICAL, ALL WELD METAL

C	Mn	Si	Cr	Ni
0.06	6.0	1.0	18.0	8.0

MECHANICAL PROPERTIES, TYPICAL, ALL WELD METAL

Condition	0.2% Proof strength [N/mm ²]	Tensile strength [N/mm ²]	Elongation [%]	Impact ISO-V(J)	
				+20°C	-10°C
Required: AWS A5.4 ISO 3581-A Typical values	not required min. 350	min. 590 min. 500	min. 30 min. 25	not required not required	
AW	425	650	35	85	60

PACKAGING AND AVAILABLE SIZES

Carton + PE foil	Diameter (mm)	3.2	4.0
	Length (mm)	350	450
Pieces / unit	Net weight/unit (kg)	94	62
		4.7	6.0

Identification Imprint: AROSTA 307-160 Tip Color: red

Arosta® 307-160: rev. C-EN06-01/02/16

Arosta® 307-160

EXAMPLES OF MATERIALS TO BE WELDED

Various steel grades, such as:

- Armour plate
- Hardenable steels including steels difficult to weld
- Non-magnetic austenitic steels
- Work hardening austenitic manganese steels
- Dissimilar steel grades (CMn-steels to stainless steel)

CALCULATION DATA

Sizes Diam. x length (mm)	Current range (A)	Current type	Arc time	Energy	Dep. rate	Weight/ 1000 pcs (kg)	Electrodes/ kg weldmetal B	kg electrodes/ kg weldmetal 1/N
			- per electrode at max. current - (S)*	E(kJ)	H(kg/h)			
3.2 x 350	110-150	DC+	53	132	1.4	29,1	48	1,39
4.0 x 450	140-200	DC+	86	264	1.7	55,9	25	1,41

*Stub end 35mm

WELDING PARAMETERS, OPTIMUM FILL PASSES

Diameter (mm)	Welding positions		
	PA/1G	PB/2F	PC/2G
3.2	150A	140A	140A
4.0	200A	180A	160A

REMARKS / APPLICATION ADVICE

Deviations: chemical composition

Mn = 4.5 - 7.5%

Cr = 17.0 - 20.0%

Ni = 7.0 - 10.0%

AWS: Mn = 3.30 - 4.75%

AWS: Cr = 18.0 - 21.5%

AWS: Ni = 9.0 - 10.7%

Jungo® 307

SMAW

CLASSIFICATION

AWS A5.4 E307-15* A-Nr 8 Mat-Nr 1.4370
 ISO 3581-A E 18 8 Mn B 2 2 F-Nr 5
 *:Deviation,see remarks 9606 FM 5

TEMPERATURE RANGE

Pressurized parts : -120...+350°C
 Oxidation resistance : n.a

GENERAL DESCRIPTION

A fully basic all position 5%Mn-alloyed stainless steel electrode
 Especially developed for steels difficult to weld, such as armour lates and austenitic high Mn-steels
 Often used as a buffer layer in hardfacing applications
 Weldable on DC+ polarity

WELDING POSITIONS (ISO/ASME)



PA/1G



PB/2F



PC/2G



PF/3Gu



PE/4G



PH/5Gu

CURRENT TYPE

AC/DC +

CHEMICAL COMPOSITION (W%), TYPICAL, ALL WELD METAL

C	Mn	Si	Cr	Ni
0.08	5.5	0.3	19.0	8.5

MECHANICAL PROPERTIES, TYPICAL, ALL WELD METAL

Condition	0.2% Proof strength [N/mm ²]	Tensile strength [N/mm ²]	Elongation [%]	Impact ISO-V(J)	
				+20°C	-120°C
Required: AWS A5.4 ISO 3581-A	not required	min. 590 min. 500	min. 30 min. 25	not required	not required
Typical values AW	500	650	35	100	35

PACKAGING AND AVAILABLE SIZES

	Diameter (mm)	3.2	4.0
	Length (mm)	350	450
Carton + PE foil	Pieces / unit	170	110
	Net weight/unit (kg)	5.0	6.5
SRP	Pieces / unit	56	-
	Net weight/unit (kg)	1.8	-

Identification Imprint: JUNG0 307

Tip Color: silver

Jungo 307- rev. C-ENZ-01/02/16

Jungo[®] 307

EXAMPLES OF MATERIALS TO BE WELDED

Various steel grades, such as:

- Armour plate
- Hardenable steels including steels difficult to weld
- Non-magnetic austenitic steels
- Work hardening austenitic manganese steels
- Dissimilar joints
- Problem steels

CALCULATION DATA

Sizes Diam. x length (mm)	Current range (A)	Current type	Arc time - per electrode at max. current - (S)*	Energy E(kJ)	Dep. rate H(kg/h)	Weight/ 1000 pcs (kg)	Electrodes/ kg weldmetal B	kg electrodes/ kg weldmetal 1/N
3.2 x 350	70 - 100	DC+	53	132	1.4	29.1	48	1.39
4.0 x 450	100 - 130	DC+	86	264	1.7	55.9	25	1.41

*Stub end 35mm

WELDING PARAMETERS, OPTIMUM FILL PASSES

Diameter (mm)	Welding positions			
	PA/1G	PB/2F	PC/2G	PF/3Gup
3.2	90A	90A	90A	70A
4.0	140A	115A	130A	95A

REMARKS / APPLICATION ADVICE

Deviations: chemical composition

Mn = 4.5 - 6.5%

Ni = 7.5 - 9.5%

AWS: Mn = 3.30 - 4.75%

AWS: Ni = 9.0 - 10.7%

Arosta® 304H

CLASSIFICATION

AWS A5.4	E308H-16	A-Nr	8	Mat-Nr	1.4829
ISO 3581-A	E 19 9 H R 12	F-Nr	5		
		9606 FM	5		

TEMPERATURE RANGE

Pressurized parts : -20...+730°C
Oxidation resistance : to 800°C

GENERAL DESCRIPTION

A rutile-basic all position stainless steel electrode
Specially developed for high temperature applications (up to 730°C) - e.g. AISI 304H or Mat. Nr 1.4948
Low sensitivity to precipitation of intermetallic phases
Weldable on AC and DC
Petrochemical and chemical industry

WELDING POSITIONS (ISO/ASME)



PA/1G



PB/2F



PC/2G



PF/3Gu



PE/4G



PH/5Gu

CURRENT TYPE

AC/DC +/-

CHEMICAL COMPOSITION (W%), TYPICAL, ALL WELD METAL

C	Mn	Si	Cr	Ni	FN (acc.WRC 1992)
0.05	0.75	0.85	18.5	9.5	3-7

MECHANICAL PROPERTIES, TYPICAL, ALL WELD METAL

Condition	0.2% Proof strength (N/mm ²)	Tensile strength (N/mm ²)	Elongation (%)	Impact ISO-V(J)	
				+20°C	-20°C
Required: AWS A5.4 ISO 3581-A Typical values	not required min. 350	min. 550 min. 550 600	min. 35 min. 30 44	not required not required 85	50
AW	450				

PACKAGING AND AVAILABLE SIZES

Carton + PE foil	Diameter (mm)	2.5	3.2	4.0
	Length (mm)	350	350	350
Pieces / unit	Net weight/unit (kg)	145	150	100
		2.8	4.8	4.9

Identification Imprint: 308H-16 / AROSTA 304 H Tip Color: green

Arosta® 304H: rev. C-EN25-01/02/16

All information in this data sheet is accurate to the best of our knowledge at the time of printing. Please refer to www.lincolnelectric.eu for any updated information.
Fumes: Safety Data Sheets (SDS) are available on our website.

Arosta[®] 304H

EXAMPLES OF MATERIALS TO BE WELDED

Steel grades	EN 10088-1/-2	EN 10213-4	Mat. Nr	ASTM/ACI	UNS
Medium carbon [C >0.03%]					302
	X4CrNi18-10		1.4301	(TP)304 (TP)304H	S30400 S30409
		GX5CrNi19-10	1.4308 1.4948	CF8	J92600
Ti-, Nb stabilized					
	X6CrNiTi18-10		1.4541	(TP)321 (TP)321H	S32100 S32109
	X6CrNiNb18-10		1.4550	(TP)347 (TP)347H	S34700 S34709
		GX5CrNiNb19-10	1.4552	CF-8C	J92710

SMAW

CALCULATION DATA

Sizes	Current range	Current type	Arc time	Energy	Dep. rate	Weight/	Electrodes/	kg electrodes/
Diam. x length	[A]		- per electrode at max. current -	- per electrode at max. current -	- per electrode at max. current -	1000 pcs	kg weldmetal	kg weldmetal
[mm]			[S]*	E[kJ]	H[kg/h]	[kg]	B	1/N
2.5 x 350	40 - 75	DC+	51	89	0.99	19.4	79	1.54
3.2 x 350	60 - 110	DC+	58	121	1.3	31.5	48	1.52
4.0 x 350	80 - 150	DC+	64	258	1.8	48.0	32	1.54

*Stub end 35mm

WELDING PARAMETERS, OPTIMUM FILL PASSES

Diameter [mm]	Welding positions					
	PA/1G	PB/2F	PC/2G	PF/3Gup	PE/4G	PH/5Gup
2.5	70A	70A	70A	60A	60A	60A
3.2	100A	100A	100A	70A	70A	70A
4.0	140A	140A	140A	80A		

Arosta® 309H

EMR
SAHARA®

CLASSIFICATION

AWS A5.4	E309H-16*	A-Nr	8	Mat-Nr	1.4829
ISO 3581-A	E 23 12 R 3 2*	F-Nr	5		
*:Deviation, see remarks		9606 FM	5		

TEMPERATURE RANGE

Pressurized parts : -10...+400°C
Oxidation resistance : to 1100°C

GENERAL DESCRIPTION

A rutile basic all position stainless steel electrode
Specially developed for high temperature applications like industrial furnaces (ovens)
High resistance to oxidation up to 1050°C
Weldable on AC and DC

WELDING POSITIONS (ISO/ASME)



PA/1G



PB/2F



PC/2G



PF/3Gu



PE/4G



PH/5Gu

CURRENT TYPE

AC/DC +/-

CHEMICAL COMPOSITION (W%), TYPICAL, ALL WELD METAL

C	Mn	Si	Cr	Ni	FN (acc.WRC 1992)
0.10	0.8	1.6	22.0	11.0	3-8

MECHANICAL PROPERTIES, TYPICAL, ALL WELD METAL

Condition	0.2% Proof strength (N/mm ²)	Tensile strength (N/mm ²)	Elongation (%)	Impact ISO-V(J)	
				+20°C	
Required: AWS A5.4 ISO 3581-A Typical values	not required min. 350	min. 550 min. 550 700	min. 30 min. 25 30	not required not required	50
AW	500				

PACKAGING AND AVAILABLE SIZES

Carton + PE foil	Diameter (mm)	2.5	3.2
	Length (mm)	350	350
Pieces / unit	Pieces / unit	120	130
	Net weight/unit (kg)	2.6	4.8

Identification Imprint: AROSTA 309 H

Tip Color: yellow

Arosta® 309H: rev. C-EN25-01/02/16

Arosta® 309H

EXAMPLES OF MATERIALS TO BE WELDED

Steel grades	EN 10088-1/-2	EN 10213-4	Mat. Nr	ASTM/ACI	UNS
		GX30CrSi6	1.4710		
	X10CrAl7		1.4713	502	
	X10CrAl13		1.4724	410/414-TP405-CA15	
		GX40CrSi13	1.4729		
		GX40CrSi17	1.4740		
	X10CrAl18		1.4742	430-TP430-CB30	
	X10CrAl24		1.4762	TP443	
		GX25CrNiSi18-9	1.4825		J92502
		GX40CrNiSi22-9	1.4826		
	X15CrNiSi20-12		1.4828	TP309	S30900
		GX25CrNiSi20-14	1.4832		
	X12CrNiTi18-9				

SMAW

CALCULATION DATA

Sizes Diam. x length [mm]	Current range [A]	Current type	Arc time - per electrode at max. current - [S]*	Energy E[kJ]	Dep. rate H[kg/h]	Weight/ 1000 pcs [kg]	Electrodes/ kg weldmetal B	kg electrodes/ kg weldmetal 1/N
2.5 x 350	40-110	DC+	47	71	1.1	19.7	73	1.44
3.2 x 350	60-120	DC+	58	140	1.5	31.9	42	1.33

*Stub end 35mm

WELDING PARAMETERS, OPTIMUM FILL PASSES

Diameter [mm]	Welding positions					
	PA/1G	PB/2F	PC/2G	PF/3Gup	PE/4G	PH/5Gup
2.5	70A	70A	70A	60A	60A	60A
3.2	100A	100A	100A	70A	70A	70A

REMARKS / APPLICATION ADVICE

Deviations: chemical composition

Si = max. 2.0%

Cr = 20.0 - 23.0%

Ni = 10.0 - 13.0%

AWS: Si = max. 1.0%

AWS: Cr = 22.0 - 25.0%

AWS: Ni = 12.0 - 14.0%

EN: Si = max. 1.2%

Intherma® 310

EMR
SAHARA®

SMAW

CLASSIFICATION

AWS A5.4	E310-16	A-Nr	9	Mat-Nr	1.4842
ISO 3581-A	E 25 20 R 12	F-Nr	5		
		9606 FM	5		

TEMPERATURE RANGE

Pressurized parts : -20...+400°C
Oxidation resistance : to 1200°C

GENERAL DESCRIPTION

Rutile basic electrode for all position welding except vertical down
Fully austenitic weld metal with high Cr and Ni content for very high service temperature
High resistance against oxidation and scaling up to 1200°C
Weldable on AC and DC

WELDING POSITIONS (ISO/ASME)

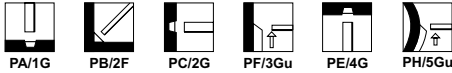

CURRENT TYPE

AC/DC +

CHEMICAL COMPOSITION (W%), TYPICAL, ALL WELD METAL

C	Mn	Si	Cr	Ni	FN (acc.WRC 1992)
0.12	2.5	0.5	26.0	20.5	0

MECHANICAL PROPERTIES, TYPICAL, ALL WELD METAL

Condition	0.2% Proof strength [N/mm ²]	Tensile strength [N/mm ²]	Elongation [%]	Impact ISO-V(J) +20°C
Required: AWS A5.4 ISO 3581-A Typical values	not required min. 350 440	min. 550 min. 550 600	min. 30 min. 20 30	not required not required 80
AW				

PACKAGING AND AVAILABLE SIZES

Carton + PE foil	Diameter (mm)	2.5	3.2	4.0
	Length (mm)	350	350	350
Pieces / unit	Net weight/unit (kg)	145	150	100
		3.0	5.1	5.1

Identification Imprint: 310-16 / INTHERMA 310 Tip Color: dark green

Intherma®310: rev. C-EN25-01/02/16

All information in this data sheet is accurate to the best of our knowledge at the time of printing. Please refer to www.lincolnelectric.eu for any updated information.
Fumes: Safety Data Sheets (SDS) are available on our website.

Intherma[®] 310

EXAMPLES OF MATERIALS TO BE WELDED

Steel grades	EN 10088-1/-2	EN 10213-4	Mat. Nr	ASTM/AISI A240/A351	UNS
Heat resisting steels					
	X10CrAl24		1.4762		
		GX25CrNiSi18-9	1.4825		
		GX40CrNiSi22-9	1.4826		
	X15CrNiSi20-12		1.4828		
		GX25CrNiSi20-14	1.4832		
	X15CrNiSi25-20		1.4841	310S	S31008
				CK20	J94202
	X12CrNi25-21		1.4845		
		GX40CrNiSi25-20	1.4848	HK40	

SMAW

CALCULATION DATA

Sizes		Current type	Arc time - per electrode at max. current - [S]*	Energy E(kJ)	Dep. rate H(kg/h)	Weight/ 1000 pcs (kg)	Electrodes/ kg weldmetal B	kg electrodes/ kg weldmetal 1/N
Diam. x length (mm)	Current range (A)							
2.5 x 350	80-110	DC+	50	84	0.74	18.9	97	1.83
3.2 x 350	90-140	DC+	56	155	1.31	31.8	49	1.56
4.0 x 350	130-175	DC+	72	233	1.55	50.7	32	1.64

*Stub end 35mm

WELDING PARAMETERS, OPTIMUM FILL PASSES

Diameter (mm)	Welding positions					
	PA/1G	PB/2F	PC/2G	PF/3Gup	PE/4G	PH/5Gup
2.5	100A	100A	100A	90A	90A	90A
3.2	130A	120A	130A	110A	110A	110A
4.0	160A	160A	160A	140A		

REMARKS / APPLICATION ADVICE

Welding with Heat-Input max. 1.5 kJ/mm
Interpass temperature max. 100°C

Intherma® 310B

SMAW

CLASSIFICATION

AWS A5.4 E310-15* A-Nr 9 Mat-Nr 1.4842
 ISO 3581-A E 25 20 B 12 F-Nr 5
 *:Deviation, see remarks 9606 FM 5

TEMPERATURE RANGE

Pressurized parts : -20...+400°C
 Oxidation resistance : to 1200°C

GENERAL DESCRIPTION

Basic coated electrode for all position welding except vertical down
 Fully austenitic weld metal with high Cr and Ni content for very high service temperature
 High resistance against oxidation and scaling up to 1200°C
 Avoid service temperatures between 650 - 850°C
 Weldable on DC only

WELDING POSITIONS (ISO/ASME)

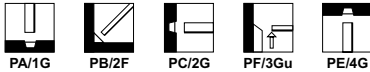

CURRENT TYPE

DC +

CHEMICAL COMPOSITION (W%), TYPICAL, ALL WELD METAL

C	Mn	Si	Cr	Ni	FN (acc.WRC 1992)
0.1	3.0	0.3	25.0	21.0	0

MECHANICAL PROPERTIES, TYPICAL, ALL WELD METAL

Condition	0.2% Proof strength [N/mm ²]	Tensile strength [N/mm ²]	Elongation [%]	Impact ISO-V(J) +20°C
Required: AWS A5.4 ISO 3581-A Typical values	not required min. 350 440	min. 550 min. 550 600	min. 30 min. 20 30	not required not required 100
AW				

PACKAGING AND AVAILABLE SIZES

	Diameter (mm)	2.5	3.2	4.0
Length (mm)	350	350	350	
Carton + PE foil	Pieces / unit	135	150	100
	Net weight/unit (kg)	2.4	4.3	4.3

Identification Imprint: INTHERMA 310 B Tip Color: dark green

Intherma®310B; rev. C-EN24-01/02/16

All information in this data sheet is accurate to the best of our knowledge at the time of printing. Please refer to www.lincolnelectric.eu for any updated information.
 Fumes: Safety Data Sheets (SDS) are available on our website.

Intherma® 310B

EXAMPLES OF MATERIALS TO BE WELDED

Steel grades	EN 10088-1/-2	EN 10213-4	Mat. Nr	ASTM/ACI A240/A351	UNS
Heat resisting steels					
	X10CrAl24		1.4762		
		GX25CrNiSi18-9	1.4825		
		GX40CrNiSi22-9	1.4826		
	X15CrNiSi20-12		1.4828		
		GX25CrNiSi20-14	1.4832		
	X15CrNiSi25-20		1.4841	310S	S31008
			1.4832	CK20	J94202
	X12CrNi25-21		1.4845		
		GX40CrNiSi25-20	1.4848	HK40	

SMAW

CALCULATION DATA

Sizes

Diam. x length (mm)	Current range (A)
2.5 x 350	60-70
3.2 x 350	80-90
4.0 x 350	110-130

*Stub end 35mm

REMARKS / APPLICATION ADVICE

Deviations: chemical composition

Mn = max. 5.0%

AWS: Mn = 1.0 - 2.5%

Welding with Heat-Input max. 1.5 kJ/mm

Interpass temperature max. 100°C

Linux P 308L

CLASSIFICATION

AWS A5.4	E308L-16	A-Nr	8	Mat-Nr	1.4316
ISO 3581-A	E 19 9 L R 3 2	F-Nr	5		
		9606 FM	5		

TEMPERATURE RANGE

Pressurized parts :-196...+350°C
 Oxidation resistance :to 800°C

GENERAL DESCRIPTION

A rutile stainless steel electrode for 304L or equivalent steels
 All positional welding including fixed pipework
 Smooth weld appearance
 Minimum spatter and high resistance to porosity
 Good side wall wetting, no undercut
 Easy slag removal
 Weldable on AC and DC
 Also available in PROTECH™ Vacuum Pack

WELDING POSITIONS (ISO/ASME)

PA/1G



PB/2F



PC/2G



PF/3Gu



PE/4G



PH/5Gu

CURRENT TYPE

AC / DC +

APPROVALS

ABS	TÜV
+	+

CHEMICAL COMPOSITION (W%), TYPICAL, ALL WELD METAL

C	Mn	Si	Cr	Ni	FN (acc.WRC 1992)
0.025	0.8	0.6	19.0	9.5	3-10

MECHANICAL PROPERTIES, TYPICAL, ALL WELD METAL

Condition	0.2% Proof strength (N/mm ²)	Tensile strength (N/mm ²)	Elongation (%)	Impact ISO-V(J) -100°C
Required: AWS A5.4 ISO 3581-A Typical values	not required min. 310 450	min. 520 min. 510 590	min. 35 min. 30 45	35

PACKAGING AND AVAILABLE SIZES

	Diameter (mm)	2.0	2.5	3.2	4.0
	Length (mm)	300	350	350	450
Carton + PE foil	Pieces / unit	194	119	82	55
	Net weight/unit (kg)	2.13	2.38	2.7	3.59
Protech™	Pieces / unit	158	110	70	46
	Net weight/unit (kg)	1.74	2.2	2.33	3.0

Identification Imprint: 308L-16 / LINOX P 308L Tip Color: none

LinuxP308L: rev. C-EN01-01/02/16

All information in this data sheet is accurate to the best of our knowledge at the time of printing. Please refer to www.lincolnelectric.eu for any updated information.
 Fumes: Safety Data Sheets (SDS) are available on our website.

Linux P 308L

EXAMPLES OF MATERIALS TO BE WELDED

Steel grades	EN 10088-1/-2	EN 10213-4	Mat. Nr	ASTM/ACI A240/A312/A351	UNS
Extra low carbon [C <0.03%]	X2CrNi19-11		1.4306	(TP)304L CF-3	S30403 J92500
Medium carbon [C >0.03%]	X4CrNi18-10		1.4301	(TP)304	S30409
		GX5CrNi19-10	1.4308	CF 8	J92600
Ti-, Nb stabilized	X6CrNiTi18-10		1.4541	(TP)321 (TP)321H	S32100 S32109
	X6CrNiNb18-10		1.4550	(TP)347 (TP)347H	S34700 S34709
		GX5CrNiNb19-10	1.4552	CF-8C	J92710

SMAW

WELDING PARAMETERS, OPTIMUM FILL PASSES

Diameter (mm)	Welding positions					
	PA/1G	PB/2F	PC/2G	PF/3Gup	PE/4G	PH/5Gup
2.0		45A	45A	40A	40A	40A
2.5	70A	70A	70A	60A	60A	60A
3.2	100A	100A	100A	70A	70A	70A
4.0	140A	140A	140A	80A		

Linux 308L

CLASSIFICATION

AWS A5.4	E308L-17	A-Nr	8	Mat-Nr	1.4316
ISO 3581-A	E 19 9 L R 3 2	F-Nr	5		
		9606 FM	5		

TEMPERATURE RANGE

Pressurized parts :-196...+350°C
 Oxidation resistance :to 800°C

GENERAL DESCRIPTION

A rutile stainless steel electrode for 304L or equivalent steels
 Smooth weld appearance
 Minimum spatter and high resistance to porosity
 Good side wall wetting, no undercut
 Easy slag removal
 Weldable on AC and DC
 Also available in PROTECH™ Vacuum Pack

WELDING POSITIONS (ISO/ASME)

PA/1G



PB/2F



PC/2G



PF/3Gu



PE/4G

CURRENT TYPE

AC / DC +

APPROVALS

ABS	DNV	TÜV
+	Pending	+

CHEMICAL COMPOSITION (W%), TYPICAL, ALL WELD METAL

C	Mn	Si	Cr	Ni	FN (acc.WRC 1992)
0.025	0.8	0.8	19.0	9.5	3-10

MECHANICAL PROPERTIES, TYPICAL, ALL WELD METAL

Condition	0.2% Proof strength (N/mm ²)	Tensile strength (N/mm ²)	Elongation (%)	Impact ISO-V(J)	
				+20°C	-20°C
Required: AWS A5.4 ISO 3581-A Typical values	not required min. 310 450	min. 520 min. 510 590	min. 35 min. 30 45	not required not required 70	- 50

PACKAGING AND AVAILABLE SIZES

	Diameter (mm) Length (mm)	2.0	2.5	3.2	4.0	5.0
		300	350	350	450	450
Carton + PE foil	Pieces / unit	196	120	80	55	32
	Net weight/unit (kg)	2.3	2.53	2.78	3.69	3.43
Protech™	Pieces / unit	160	110	69	45	30
	Net weight/unit (kg)	1.84	2.32	2.4	3.09	3.2

Identification Imprint: 308L-17 / LINOX 308 L Tip Color: none

Linux308L:rev. C-EN03-01/02/16

All information in this data sheet is accurate to the best of our knowledge at the time of printing. Please refer to www.lincolnelectric.eu for any updated information.
 Fumes: Safety Data Sheets (SDS) are available on our website.

Linco 308L

EXAMPLES OF MATERIALS TO BE WELDED

Steel grades	EN 10088-1/-2	EN 10213-4	Mat. Nr	ASTM/ACI A240/A312/A351	UNS
Extra low carbon [C <0.03%]					
	X2CrNi19-11		1.4306	(TP)304L CF-3	S30403 J92500
Medium carbon [C >0.03%]					
	X4CrNi18-10		1.4301	(TP)304	S30409
		GX5CrNi19-10	1.4308	CF 8	J92600
Ti-, Nb stabilized					
	X6CrNiTi18-10		1.4541	(TP)321 (TP)321H	S32100 S32109
	X6CrNiNb18-10		1.4550	(TP)347 (TP)347H	S34700 S34709
		GX5CrNiNb19-10	1.4552	CF-8C	J92710

SMAW

WELDING PARAMETERS, OPTIMUM FILL PASSES

Diameter (mm)	Welding positions				
	PA/1G	PB/2F	PC/2G	PF/3Gup	PE/4G
2.0		45A	45A	40A	40A
2.5	70A	70A	70A	60A	60A
3.2	100A	100A	100A	70A	70A
4.0	140A	140A	140A		
5.0	180A	180A			

Linux P 316L

SMAW

CLASSIFICATION

AWS A5.4 E316L-16 A-Nr 8 Mat-Nr 1.4430
 ISO 3581-A E 19 12 3 L R 32 F-Nr 5
 9606 FM 5

TEMPERATURE RANGE

Pressurized parts :-120...+350°C
 Oxidation resistance : n.a

GENERAL DESCRIPTION

A rutile stainless steel electrode for 316L or equivalent steels
 All positional welding including fixed pipework
 Smooth weld appearance
 Minimum spatter and high resistance to porosity
 Good side wall wetting, no undercut
 Easy slag removal
 Weldable on AC and DC
 Also available in PROTECH™ Vacuum Pack

WELDING POSITIONS (ISO/ASME)



PA/1G



PB/2F



PC/2G



PF/3Gu



PE/4G



PH/5Gu

CURRENT TYPE

AC / DC +

APPROVALS

ABS TÜV
 + +

CHEMICAL COMPOSITION (W%), TYPICAL, ALL WELD METAL

C	Mn	Si	Cr	Ni	Mo	FN [acc.WRC 1992]
0.025	0.8	0.6	19.0	12.0	2.5	3-10

MECHANICAL PROPERTIES, TYPICAL, ALL WELD METAL

Condition	0.2% Proof strength [N/mm ²]	Tensile strength [N/mm ²]	Elongation [%]	Impact ISO-V[J]	
				+20°C	-105°C
Required: AWS A5.4 ISO 3581-A Typical values	not required min. 320 480	min. 520 min. 510 580	min. 30 min. 25 41	not required not required 70	not required not required 40

PACKAGING AND AVAILABLE SIZES

	Diameter (mm) Length (mm)	2.0	2.5	3.2	4.0	5.0
		300	350	350	450	450
Carton + PE foil	Pieces / unit	195	119	79	55	32
	Net weight/unit (kg)	2.15	2.41	2.7	3.62	3.29
Protech™	Pieces / unit	159	110	70	46	28
	Net weight/unit (kg)	1.75	2.21	2.34	3.05	3.11

Identification Imprint: 316L-16 / LINOX P 316L Tip Color: none

LinuxP316L:rev.C-EN03-12/0716

Linux P 316L

EXAMPLES OF MATERIALS TO BE WELDED

Steel grades	EN 10088-1/-2	EN 10213-4	Mat. Nr	ASTM/ACI A240/A312/A351	UNS
Extra low carbon [C <0.03%]					
	X2CrNiMo17-12-2		1.4404	(TP)316L CF-3M	S31603 J92800
	X2CrNiMo18-14-3		1.4435	(TP)316L	S31603
Medium carbon [C >0.03%]					
	X4CrNiMo17-12-2		1.4401	(TP)316	S31600
	X4CrNiMo17-13-3		1.4436		
		GX5CrNiMo19-11	1.4408	CF 8M	J92900
Ti-, Nb stabilized					
	X6CrNiMoTi17-12-2		1.4571	316Ti	S31635
	X6CrNiMoNb17-12-2		1.4580	316Cb	S31640
	X6CrNiNb18-10		1.4550	(TP)347	S34700
		GX5CrNiNb19-10	1.4552	CF-8C	J92710

SMAW

WELDING PARAMETERS, OPTIMUM FILL PASSES

Diameter (mm)	Welding positions					
	PA/1G	PB/2F	PC/2G	PF/3Gup	PE/4G	PH/5Gup
2.0	40A	45A	45A	40A	40A	40A
2.5	70A	70A	70A	60A	60A	60A
3.2	100A	100A	100A	70A	70A	70A
4.0	140A	140A	140A	80A		
5.0	180A	180A	180A			

Linux 316L

CLASSIFICATION

AWS A5.4	E316L-17	A-Nr	8	Mat-Nr	1.4430
ISO 3581-A	E 19 12 3 L R 3 2	F-Nr	5		
		9606 FM	5		

TEMPERATURE RANGE

Pressurized parts :-120...+350°C
 Oxidation resistance : n.a

GENERAL DESCRIPTION

A rutile-basic stainless steel electrode for 316L or equivalent steels
 Smooth weld appearance
 Minimum spatter and high resistance to porosity
 Good side wall wetting, no undercut
 Easy slag removal
 Weldable on AC and DC
 Also available in PROTECH™ Vacuum Pack

WELDING POSITIONS (ISO/ASME)

PA/1G



PB/2F



PC/2G



PF/3Gu



PE/4G

CURRENT TYPE

AC / DC +

APPROVALS

ABS	DNV	TÜV
+	Pending	+

CHEMICAL COMPOSITION (W%), TYPICAL, ALL WELD METAL

C	Mn	Si	Cr	Ni	Mo	FN (acc.WRC 1992)
0.025	0.8	0.8	18.0	12.0	2.5	3-10

MECHANICAL PROPERTIES, TYPICAL, ALL WELD METAL

Condition	0.2% Proof strength (N/mm ²)	Tensile strength (N/mm ²)	Elongation (%)	Impact ISO-V(J)	
				+20°C	-105°C
Required: AWS A5.4 ISO 3581-A Typical values	not required min. 320 480	min. 490 min. 510 600	min. 30 min. 25 42	not required not required 70	40

PACKAGING AND AVAILABLE SIZES

	Diameter (mm) Length (mm)	2.0	2.5	3.2	4.0	5.0
		300	350	350	450	450
Carton + PE foil	Pieces / unit	196	120	80	55	31
	Net weight/unit (kg)	2.3	2.53	2.78	3.75	3.41
Protech™	Pieces / unit	160	110	69	46	28
	Net weight/unit (kg)	1.84	2.32	2.4	3.12	3.08

Identification Imprint: 316L-17 / LINOX 316 L Tip Color: none

Linux316L.rev.C-EN03-01/02/16

All information in this data sheet is accurate to the best of our knowledge at the time of printing. Please refer to www.lincolnelectric.eu for any updated information.
 Fumes: Safety Data Sheets (SDS) are available on our website.

Linux 316L

EXAMPLES OF MATERIALS TO BE WELDED

Steel grades	EN 10088-1/-2	EN 10213-4	Mat. Nr	ASTM/ACI A240/A312/A351	UNS
Extra low carbon [C <0.03%]					
	X2CrNiMo17-12-2		1.4404	(TP)316L CF-3M	S31603 J92800
	X2CrNiMo18-14-3		1.4435	(TP)316L	S31603
Medium carbon [C >0.03%]					
	X4CrNiMo17-12-2		1.4401	(TP)316	S31600
	X4CrNiMo17-13-3		1.4436		
		GX5CrNiMo19-11	1.4408	CF 8M	J92900
Ti-, Nb stabilized					
	X6CrNiMoTi17-12-2		1.4571	316Ti	S31635
	X6CrNiMoNb17-12-2		1.4580	316Cb	S31640
	X6CrNiNb18-10		1.4550	(TP)347	S34700
		GX5CrNiNb19-10	1.4552	CF-8C	J92710

SMAW

WELDING PARAMETERS, OPTIMUM FILL PASSES

Diameter (mm)	Welding positions				
	PA/1G	PB/2F	PC/2G	PF/3Gup	PE/4G
2.0	40A	45A	45A	40A	40A
2.5	70A	70A	70A	60A	60A
3.2	100A	100A	100A	70A	70A
4.0	140A	140A	140A		
5.0	180A	180A			

Linux P 309L

CLASSIFICATION

AWS A5.4	E309L-16	A-Nr	8	Mat-Nr	1.4332
ISO 3581-A	E 23 12 L R 3 2	F-Nr	5		
		9606 FM	5		

TEMPERATURE RANGE

Pressurized parts :-20...+350°C
 Oxidation resistance : n.a

GENERAL DESCRIPTION

A rutile all position CrNi over-alloyed buffer electrode
 All positional welding including fixed pipework
 Suitable for welding stainless steel to mild and low alloy steels, stainless steel cladding
 Smooth weld appearance
 Minimum spatter and high resistance to porosity
 Good side wall wetting, no undercut
 Easy slag removal
 Weldable on AC and DC
 Also available in PROTECH™ Vacuum Pack

WELDING POSITIONS (ISO/ASME)

PA/1G



PB/2F



PC/2G



PF/3Gu



PE/4G



PH/5Gu

CURRENT TYPE

AC/DC +

APPROVALS

ABS	TÜV
-----	-----

+	+
---	---

CHEMICAL COMPOSITION (W%), TYPICAL, ALL WELD METAL

C	Mn	Si	Cr	Ni	FN (acc.WRC 1992)
0.025	0.8	0.6	23.5	13.0	8-20

MECHANICAL PROPERTIES, TYPICAL, ALL WELD METAL

Condition	0.2% Proof strength (N/mm ²)	Tensile strength (N/mm ²)	Elongation (%)	Impact ISO-V(J) -20°C
Required: AWS A5.4 ISO 3581-A Typical values	not required min. 320	min. 520 min. 510	min. 30 min. 25	not required not required
AW	495	595	41	45

PACKAGING AND AVAILABLE SIZES

	Diameter (mm)	2.5	3.2	4.0
	Length (mm)	350	350	450
Carton + PE foil	Pieces / unit	119	80	55
	Net weight/unit (kg)	2.49	2.8	3.76
Protech™	Pieces / unit	110	70	46
	Net weight/unit (kg)	2.31	2.42	3.15

Identification Imprint: 309L-17 / LINOX P 309L Tip Color: none

LinuxP309L:rev.C-ENO2-12/0716

All information in this data sheet is accurate to the best of our knowledge at the time of printing. Please refer to www.lincolnelectric.eu for any updated information.
 Fumes: Safety Data Sheets (SDS) are available on our website.

Lincoln P 309L

EXAMPLES OF MATERIALS TO BE WELDED

Steel grades	EN 10088-1/-2	Mat. Nr	ASTM/ACI A240/A312/A351	UNS
Corrosion resistant cladsteels				
	X2CrNi18-10	1.4311	(TP)304LN	S30453
	X2CrNi19-11	1.4306	(TP)304L	S30403
			CF-3	J92500
	X4CrNi18-10	1.4301	(TP)304	S30400

Dissimilar metals (mild and low alloy steel to CrNi or CrNiMo stainless steel)

Build-up welding on mild and low alloy steel

Bufferlayer CrNi-cladsteel

SMAW

WELDING PARAMETERS, OPTIMUM FILL PASSES

Diameter (mm)	Welding positions					
	PA/1G	PB/2F	PC/2G	PF/3Gup	PE/4G	PH/5Gup
2.5	70A	70A	70A	60A	60A	60A
3.2	100A	100A	100A	70A	70A	70A
4.0	140A	140A	140A	80A		

Linux 309L

SMAW

CLASSIFICATION

AWS A5.4 E309L-17 A-Nr 8 Mat-Nr 1.4332
 ISO 3581-A E 23 12 L R 3 2 F-Nr 5
 9606 FM 5

TEMPERATURE RANGE

Pressurized parts : -20...+300°C
 Oxidation resistance : n.a

GENERAL DESCRIPTION

A rutile all position CrNi over-alloyed buffer electrode
 Suitable for welding stainless steel to mild and low alloy steels, stainless steel cladding
 Smooth weld appearance
 Minimum spatter and high resistance to porosity
 Good side wall wetting, no undercut
 Easy slag removal
 Weldable on AC and DC
 Also available in PROTECH™ Vacuum Pack

WELDING POSITIONS (ISO/ASME)



PA/1G



PB/2F



PC/2G



PF/3Gu



PE/4G

CURRENT TYPE

AC/DC +

APPROVALS

ABS	DNV	TÜV
+	Pending	+

CHEMICAL COMPOSITION (W%), TYPICAL, ALL WELD METAL

C	Mn	Si	Cr	Ni	FN (acc.WRC 1992)
0.025	0.7	0.7	24.0	12.5	8-20

MECHANICAL PROPERTIES, TYPICAL, ALL WELD METAL

Condition	0.2% Proof strength [N/mm ²]	Tensile strength [N/mm ²]	Elongation [%]	Impact ISO-V(J)	
				+20°C	-20°C
Required: AWS A5.4 ISO 3581-A	not required	min. 520	min. 30	not required	
Typical values	min. 320 500	min. 510 620	min. 25 40	not required 55	40

PACKAGING AND AVAILABLE SIZES

	Diameter (mm)	2.5	3.2	4.0
	Length (mm)	350	350	450
Carton + PE foil	Pieces / unit	120	80	58
	Net weight/unit (kg)	2.59	2.9	4.12
Protech™	Pieces / unit	110	69	45
	Net weight/unit (kg)	2.37	2.5	3.2

Identification Imprint: 309L-17 / LINOX 309 L Tip Color: none

Linux309L.rev.C-EN02-01/02/16

All information in this data sheet is accurate to the best of our knowledge at the time of printing. Please refer to www.lincolnelectric.eu for any updated information.
 Fumes: Safety Data Sheets (SDS) are available on our website.

Lincoln 309L

EXAMPLES OF MATERIALS TO BE WELDED

Steel grades	EN 10088-1/-2	Mat. Nr	ASTM/ACI A240/A312/A351	UNS
Corrosion resistant cladsteels				
	X2CrNi18-10	1.4311	(TP)304LN	S30453
	X2CrNi19-11	1.4306	(TP)304L	S30403
			CF-3	J92500
	X4CrNi18-10	1.4301	(TP)304	S30400

Dissimilar metals (mild and low alloy steel to CrNi or CrNiMo stainless steel)

Build-up welding on mild and low alloy steel

Bufferlayer CrNi-cladsteel

SMAW

WELDING PARAMETERS, OPTIMUM FILL PASSES

Diameter (mm)	Welding positions				
	PA/1G	PB/2F	PC/2G	PF/3Gup	PE/4G
2.5	70A	70A	70A	60A	60A
3.2	100A	100A	100A	70A	70A
4.0	140A	140A	140A		

NiCro 31/27

SMAW

CLASSIFICATION

AWS A5.4	E383-16*	A-Nr	9	Mat-Nr	1.4563
ISO 3581-A	E 27 314 Cu L R 12	F-Nr	5		
* nearest classification		9606 FM	5		

GENERAL DESCRIPTION

A rutile-basic all position fully austenitic NiCrMoCu electrode
 Especially for phosphoric and sulphuric acid plants
 Designed for Mo and Cu alloyed high NiCr-alloyed grades
 Very smooth bead appearance and easy slag release
 Also approved for welding dissimilar metals for service up to 450°C
 High resistance to pitting (PREN ~40)

WELDING POSITIONS (ISO/ASME)



CURRENT TYPE

AC/DC +

APPROVALS

TÜV

+

CHEMICAL COMPOSITION (W%), TYPICAL, ALL WELD METAL

C	Mn	Si	Cr	Ni	Mo	Cu	Fe	FN [acc.WRC 1992]
0.02	0.8	0.9	271	31.0	3.5	0.9	bal.	0

MECHANICAL PROPERTIES, TYPICAL, ALL WELD METAL

Condition	0.2% Proof strength [N/mm ²]	Tensile strength [N/mm ²]	Elongation [%]	Impact ISO-V(J) +20°C
Required: AWS A5.4 ISO 3581-A Typical values	not required min. 240 440	min. 520 min. 500 640	min. 30 min. 25 38	not required not required 70

PACKAGING AND AVAILABLE SIZES

	Diameter [mm]	Length [mm]
	2.5	350
	3.2	350
	4.0	350
PE-Tube	Pieces / unit	Net weight/unit [kg]
	91	1.8
	66	2.0
	45	2.0

Identification Imprint: NiCro 31/27 Tip Color: orange

NiCro 31/27: rev. C-EN26-01/02/16

All information in this data sheet is accurate to the best of our knowledge at the time of printing. Please refer to www.lincolnelectric.eu for any updated information.
 Fumes: Safety Data Sheets (SDS) are available on our website.

NiCro 31/27

SMAW

EXAMPLES OF MATERIALS TO BE WELDED

Steel grades	Standard	Type	Mat. Nr	ASTM/ACI	UNS
Copper alloyed CrNiMo and NiCrMo steels	EN 10088-1/-2	X1NiCrMoCu31-27-4	1.4563	Alloy 28	N08028
		X1NiCrMoCu25-20-5	1.4539	Alloy 904L	N08904

CALCULATION DATA

Sizes Diam. x length (mm)	Current range (A)	Current type	Arc time	Energy	Dep. rate	Weight/ 1000 pcs (kg)	Electrodes/ kg weldmetal B	kg electrodes/ kg weldmetal 1/N
			- per electrode at max. current - (S)*	E(kJ)	H(kg/h)			
2.5 x 350	45-70	DC+	52	95	0.84	21.3	83	1.75
3.2 x 350	70-95	DC+	56	132	1.3	31.2	48	1.49
4.0 x 350	110-150	DC+	53	198	2.0	46.0	34	1.56

*Stub end 35mm

WELDING PARAMETERS, OPTIMUM FILL PASSES

Diameter (mm)	Welding positions					
	PA/1G	PB/2F	PC/2G	PF/3Gup	PE/4G	PH/5Gup
2.5	65A	70A	70A	70A	60A	60A
3.2	95A	95A	95A	95A	80A	80A
4.0	120A	120A				

REMARKS / APPLICATION ADVICE

Welding with Heat-Input max. 1.5 kJ/mm
Interpass temperature max. 150°C

NiCr 60/20

SMAW

CLASSIFICATION

AWS A5.11	ENiCrMo-3	A-Nr	-	Mat-Nr	2.4621
ISO 14172	E Ni 6625 (NiCr22Mo9Nb)	F-Nr	43		
		9606 FM	6		

GENERAL DESCRIPTION

Fully basic Ni-base high CrMoNb alloyed austenitic all position electrode
 Extreme high resistance to general and intergranular corrosion, pitting and crevice corrosion and stress corrosion cracking
 Suitable for welding dissimilar joints; high resistance to hot cracking
 High resistance to high temperature oxidation (max. 1200°C) and carburization
 Good impact values at low temperatures (down to -196°C), suitable for 9% Ni steel

WELDING POSITIONS (ISO/ASME)



CURRENT TYPE

DC +

APPROVALS

TÜV

+

CHEMICAL COMPOSITION (W%), TYPICAL, ALL WELD METAL

C	Mn	Si	Cr	Ni	Mo	Nb	Fe
0.03	0.5	0.35	22.0	62.0	9.0	3.4	0.9

MECHANICAL PROPERTIES, TYPICAL, ALL WELD METAL

Condition	0.2% Proof strength (N/mm ²)	Tensile strength (N/mm ²)	Elongation [%]	Impact ISO-V(J) -196°C
Required: AWS A5.11	not required	min. 760	min. 30	not required
ISO 14172	min. 420	760	min. 27	not required
Typical values	510	770	44	92

PACKAGING AND AVAILABLE SIZES

	Diameter (mm)	Length (mm)	2.5	3.2	4.0
			300	300	350
PE-Tube	Pieces / unit		94	61	45
	Net weight/unit (kg)		1.6	1.7	2.1

Identification Imprint: NiCrMo-3 / NiCr 60/20 Tip Color: green

NiCr 60/20: rev. C-EN23-01/02/16

All information in this data sheet is accurate to the best of our knowledge at the time of printing. Please refer to www.lincolnelectric.eu for any updated information. Fumes: Safety Data Sheets (SDS) are available on our website.

NiCro 60/20

SMAW

EXAMPLES OF MATERIALS TO BE WELDED

Steel grades	DIN/EN	Mat. Nr	ASTM/ACI	UNS
NiCrMo-steel type alloy 625 and welding dissimilar high NiCrMo-steels for corrosion and heat resisting purposes				
	X1NiCrMoCuN25-20-6	1,4529	Alloy 925	N08925
	X1NiCrMoCu25-20-5	1,4539	Alloy 904L	N08904
	X1CrNiMoCuN20-18-7	1,4547	Alloy 254	S31254
	X2NiCrAlTi32-20	1,4558	Alloy 800L	N08800
	G-X10NiCrNb32-20	1,4859		
	X10NiCrAlTi32-20	1,4876	Alloy 800/800H	N08800/-10
	NiCr22Mo6Cu	2,4618	Alloy G	N06007
	NiCr22Mo7Cu	2,4619	Alloy G-3	N06985
	NiCr21Mo6Cu	2,4641	Alloy 825hMo	N08821
	NiCr20CuMo	2,4660	Alloy 20	N08020
	NiCr15Fe	2,4816	B168-Alloy 600	N06600
	NiCr22Mo9Nb	2,4856	B443-Alloy 625	N06625
	NiCr21Mo	2,4858	B424-Alloy 825	N08825
	NiCr20Ti	2,4951	Alloy 75	N06075
	NiCr20TiAl	2,4952	Alloy 80A	N07080
Low alloy steels				
	10Ni14 (3.5% Ni)	1,5637	ASTM A333 Grade 3	-
	12Ni19, X12Ni5	1,5680	-	K41583
9% Ni steel for LNG storage tanks				
	X8Ni9 (9% Ni)	1,5662	A353/A353M	-
	X8Ni9 (9% Ni)	1,5662	A553/A553M Type I	-
	[8% Ni]		A553/A553M Type II	K71340

CALCULATION DATA

Sizes Diam. x length (mm)	Current range (A)	Current type	Arc time - per electrode at max. current - (S)*	Energy E(kJ)	Dep. rate H(kg/h)	Weight/ 1000 pcs (kg)	Electrodes/ kg weldmetal B	kg electrodes/ kg weldmetal 1/N
2.5 x 300	45-70	DC+	44	80	0.95	17.2	87	1.51
3.2 x 300	70-100	DC+	44	101	1.5	26.8	55	1.48
4.0 x 350	100-130	DC+	53	215	2.2	46.4	30	1.41

*Stub end 35mm

WELDING PARAMETERS, OPTIMUM FILL PASSES

Diameter (mm)	Welding positions					
	PA/1G	PB/2F	PC/2G	PF/3Gup	PE/4G	PH/5Gup
2.5	60A	55A	60A	60A	60A	60A
3.2	90A	80A	85A	80A	80A	80A
4.0	120A	120A				

REMARKS / APPLICATION ADVICE

Welding with Heat-Input max. 1.5 kJ/mm
Interpass temperature max. 150°C

NiCro 70/15

SMAW

CLASSIFICATION

AWS A5.11	ENiCrFe-2*	A-Nr	-	Mat-Nr	2.4807
ISO 14172	E Ni 6182* (NiCr15Fe6Mn)	F-Nr	43		
*:Deviation,see remarks		9606 FM	6		

GENERAL DESCRIPTION

Fully basic all position NiCr electrode
 High creep resistance up to 815°C
 High resistance to embrittlement
 High toughness at low temperature [-196°C]
 For welding, Ni base alloys (as Alloy 600) and dissimilar joints
 High resistance to carburization

WELDING POSITIONS (ISO/ASME)



PA/1G



PB/2F



PC/2G



PF/3Gu



PE/4G



PH/5Gu

CURRENT TYPE

DC +

APPROVALS

TÜV

+

CHEMICAL COMPOSITION (W%), TYPICAL, ALL WELD METAL

C	Mn	Si	Cr	Ni	Nb	Fe
0.02	4.4	0.45	18.0	bal.	1.9	6

MECHANICAL PROPERTIES, TYPICAL, ALL WELD METAL

	Condition	0.2% Proof strength (N/mm ²)	Tensile strength (N/mm ²)	Elongation (%)	Impact ISO-V(J)	
					+20°C	-196°C
Required: AWS A5.11 ISO 14172 Typical values	AW	not required min. 360 430	min. 550 min. 550 680	min. 30 min. 27 40	not required not required 145	130

PACKAGING AND AVAILABLE SIZES

	Diameter (mm)	2.5	3.2	4.0
	Length (mm)	300	300	350
PE-Tube	Pieces / unit	90	57	43
	Net weight/unit (kg)	1.6	1.9	2.0

Identification Imprint: NiCro 70/15 Tip Color: silver

NiCro 70/15: rev. C-EN24-01/02/16

All information in this data sheet is accurate to the best of our knowledge at the time of printing. Please refer to www.lincolnelectric.eu for any updated information.
 Fumes: Safety Data Sheets (SDS) are available on our website.

NiCro 70/15

SMAW

EXAMPLES OF MATERIALS TO BE WELDED

Steel grades	BS 3076	DIN 17742 SEW 470/595	Mat. Nr	ASTM / ACI B366	UNS
Ni base on Cr alloyed steels for high and low temperature service					
		LC-NiCr15Fe	2.4817		N06600
	NA14	NiCr15Fe	2.4816	Alloy600/B168	N06600
		NiCr23Fe	2.4851	Alloy601(H)	N06601
		NiCr60-15	2.4867		N06004
		NiCr80-20	2.4869		N06003
		NiCr20Ti	2.4951	Alloy75	N06075
		NiCr20TiAl	2.4952	Alloy80A	N07080
	NA17	X12NiCrSi36-16	1.4864	330	N08330
		G-X10NiCrNb32-20	1.4859		
	NA15	X10NiCrAlTi32-20	1.4876	Alloy800/800H	N08800/ N08810

Suitable for welding dissimilar metals:

- Mild- and low alloy steel to stainless steel
- Mild- and low alloy steel to Ni base alloys
- Stainless steel to low alloy creep resisting steel

Not sensitive for embrittlement after heat treatment

CALCULATION DATA

Sizes Diam. x length (mm)	Current range (A)	Current type	Arc time	Energy	Dep. rate	Weight/ 1000 pcs (kg)	Electrodes/ kg weldmetal B	kg electrodes/ kg weldmetal 1/N
			- per electrode at max. current - (S)*	E(kJ)	H(kg/h)			
2.5 x 300	45-60	DC+	44	63	0.9	17.5	91	1.59
3.2 x 300	70-100	DC+	52	107	1.3	29.2	52	1.54
4.0 x 350	90-160	DC+	61	214	2.0	51.0	29	1.47

*Stub end 35mm

WELDING PARAMETERS, OPTIMUM FILL PASSES

Diameter (mm)	Welding positions					
	PA/1G	PB/2F	PC/2G	PF/3Gup	PE/4G	PH/5Gup
2.5	60A	55A	60A	60A	60A	60A
3.2	90A	80A	85A	80A	80A	80A
4.0	120A	120A				

REMARKS / APPLICATION ADVICE

Deviations: chemical composition

Mn = 3.0 - 6.0%

Cr = max. 18.0%

Welding with Heat-Input max. 1.5 kJ/mm

Interpass temperature max. 150°C

AWS: Mn = 1.0 - 3.5%

AWS: Cr = max. 17.0%

ISO: Mn = 5.0 - 10%

ISO: Cr = max. 17%

NiCro 70/15Mn

SMAW

CLASSIFICATION

AWS A5.11	ENiCrFe-3	A-Nr	-	Mat-Nr	2.4620
ISO 14172	E Ni 6182 (NiCr15Fe6Mn)	F-Nr	43		
		9606 FM	6		

GENERAL DESCRIPTION

Fully basic all position NiCr electrode
 For welding Ni-base alloys (as Alloy 600), claddings and dissimilar metals
 High creep resistance up to 815°C
 High resistance to embrittlement
 High toughness also at low temperature [-196°C]
 High resistance to carburization
 Extra alloyed with ~6% Mn to provide hot cracking resistance

WELDING POSITIONS (ISO/ASME)

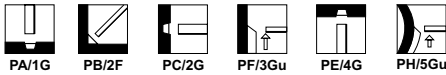

CURRENT TYPE

DC +

CHEMICAL COMPOSITION (W%), TYPICAL, ALL WELD METAL

C	Mn	Si	Cr	Ni	Nb	S	Fe
0.025	5.5	0.4	16.0	bal.	2.0	0.01	6.5

MECHANICAL PROPERTIES, TYPICAL, ALL WELD METAL

Condition	0.2% Proof strength [N/mm ²]	Tensile strength [N/mm ²]	Elongation [%]	Impact ISO-V(J) -196°C
Required: AWS A5.11 ISO 14172 Typical values	not required min. 360 400	min. 550 min. 550 630	min. 30 min. 27 40	not required not required 125

PACKAGING AND AVAILABLE SIZES

	Diameter [mm]	2.5	3.2	4.0
	Length [mm]	300	300	350
PE-Tube	Pieces / unit	91	57	39
	Net weight/unit [kg]	1.6	1.7	1.9

Identification Imprint: NiCrFe-3/ NiCRO 70/15Mn Tip Color: yellow

NiCro 70/15Mn; rev. C-EN24-01/02/16

NiCro 70/15Mn

EXAMPLES OF MATERIALS TO BE WELDED

Steel grades	BS 3076	DIN 17742 SEW 470/595	Mat. Nr	ASTM / ACI B366	UNS
Ni base on Cr alloyed steels for high and low temperature service					
		LC-NiCr15Fe	2.4817		N06600
	NA14	NiCr15Fe	2.4816	Alloy600/B168	N06600
		NiCr23Fe	2.4851	Alloy601(H)	N06601
		NiCr60-15	2.4867		N06004
		NiCr80-20	2.4869		N06003
		NiCr20Ti	2.4951	Alloy75	N06075
		NiCr20TiAl	2.4952	Alloy80A	N07080
	NA17	X12NiCrSi36-16	1.4864	330	N08330
		GX10NiCrNb32-20	1.4859		
	NA15	X10NiCrAlTi32-20	1.4876	Alloy800/800H	N08800/ N08810

Suitable for welding dissimilar metals:

- Mild- and low alloy steel to stainless steel
- Mild- and low alloy steel to Ni base alloys
- Stainless steel to low alloy creep resisting steel

Not sensitive for embrittlement after heat treatment

CALCULATION DATA

Sizes Diam. x length (mm)	Current range (A)	Current type	Arc time	Energy	Dep. rate	Weight/ 1000 pcs (kg)	Electrodes/ kg weldmetal B	kg electrodes/ kg weldmetal 1/N
			[S]*	E(kJ) - per electrode at max. current -	H(kg/h)			
2.5 x 300	40-70	DC+	80	119	0.52	17.4	86	1.49
3.2 x 300	70-100	DC+	77	193	0.84	29.0	56	1.61
4.0 x 350	90-140	DC+	74	289	1.7	50.9	29	1.47

*Stub end 35mm

WELDING PARAMETERS, OPTIMUM FILL PASSES

Diameter (mm)	Welding positions					
	PA/1G	PB/2F	PC/2G	PF/3Gup	PE/4G	PH/5Gup
2.5	60A	55A	60A	60A	60A	60A
3.2	90A	80A	90A	80A	80A	80A
4.0	120A	120A				

REMARKS / APPLICATION ADVICE

Welding with Heat-Input max. 1.5 kJ/mm
Interpass temperature max. 100°C

SMAW

NiCro 70/19

SMAW

CLASSIFICATION

AWS A5.11	ENiCrFe-2*	A-Nr	-	Mat-Nr	2.4648
ISO 14172	E Ni 6082 (NiCr20Mn3Nb)	F-Nr	43		
*:Deviation,see remarks		9606 FM	6		

GENERAL DESCRIPTION

Fully basic NiCr alloyed all position electrode
 For welding high Ni alloyed material such as Alloy 600 and Alloy 601
 Also applicable for welding dissimilar joints and for CMn- and low alloy clad steel
 High resistance to oxidation at high temperature
 High impact values at low temperature [-196°C]

WELDING POSITIONS (ISO/ASME)



CURRENT TYPE

DC +

APPROVALS

TÜV

+

CHEMICAL COMPOSITION (W%), TYPICAL, ALL WELD METAL

C	Mn	Si	Cr	Ni	Mo	Nb	Fe
0.03	4.7	0.6	19.0	bal.	1.5	1.9	4.0

MECHANICAL PROPERTIES, TYPICAL, ALL WELD METAL

Condition	0.2% Proof strength (N/mm ²)	Tensile strength (N/mm ²)	Elongation (%)	Impact ISO-V(J)	
				+20°C	-196°C
Required: AWS A5.11 ISO 14172 Typical values	not required min. 360 400	min. 550 min. 600 650	min. 30 min. 22 40	not required not required 110	
AW					90

PACKAGING AND AVAILABLE SIZES

PE-Tube	Diameter (mm)	2.5	3.2	4.0	5.0
	Length (mm)	300	300	350	450
Pieces / unit	76	57	31	45	
Net weight/unit (kg)	1.5	1.7	1.8	4.5	

Identification Imprint: NiCro 70/19 Tip Color: blue

NiCro 70/19 rev. C-EN24-01/02/16

All information in this data sheet is accurate to the best of our knowledge at the time of printing. Please refer to www.lincolnelectric.eu for any updated information. Fumes: Safety Data Sheets (SDS) are available on our website.

NiCro 70/19

SMAW

EXAMPLES OF MATERIALS TO BE WELDED

Steel grades	BS3076	DIN 17744/17465 SEW 595	Mat. Nr	ASTM/ACI B366	UNS
Ni base to CrNi alloyed steel for composition in highly corrosive environments					
	NA 14	NiCr15Fe	2.4816	B168-Alloy 600	N06600
		LC-NiCr15Fe	2.4817	Alloy 600L	N06600
		NiCr20Ti	2.4951	Alloy 75	
		NiCr20TiAl	2.4952	Alloy 80A	N07080
	NA 15	X10NiCrAlTi32-20	1.4876	Alloy 800/800H	N08800/10
		NiCr23Fe	2.4851	Alloy 601(H)	N06601
	NA 17	X12NiCrSi36-16	1.4864	330	N08330
		GX40NiCrNb35-25	1.4852		
		GX40NiCrSi35-25	1.4857	HP	

Suitable for welding dissimilar metals:

- Mild- and low alloy steel to stainless steel
- Mild- and low alloy steel to Ni base alloys
- Stainless steel to low alloy creep resisting steel

Not sensitive for embrittlement after heat treatment

CALCULATION DATA

Sizes		Current type	Arc time - per electrode at max. current - [S]*	Energy E[kJ]	Dep. rate H[kg/h]	Weight/ 1000 pcs [kg]	Electrodes/ kg weldmetal B	kg electrodes/ kg weldmetal 1/N
Diam. x length [mm]	Current range [A]							
2.5 x 300	45-65	DC+	41	61	0.95	19.3	92	1.79
3.2 x 300	70-95	DC+	59	127	1.2	32.7	51	1.64
4.0 x 350	100-140	DC+	75	314	1.7	59.3	29	1.72

*Stub end 35mm

WELDING PARAMETERS, OPTIMUM FILL PASSES

Diameter [mm]	Welding positions					
	PA/1G	PB/2F	PC/2G	PF/3Gup	PE/4G	PH/5Gup
2.5	60A	55A	60A	60A	60A	60A
3.2	90A	80A	90A	80A	80A	80A
4.0	120A	120A				

REMARKS / APPLICATION ADVICE

Deviations: chemical composition

Mn = 2.0 - 6.0%

Cr = 18.0 - 22.0%

Welding with Heat-Input max. 1.5 kJ/mm

Interpass temperature max. 150°C

AWS: Mn = 1.0 - 3.5%

AWS: Mn = 13.0 - 17%

Nyloid 2

SMAW

CLASSIFICATION

AWS A5.11	ENiCrMo-6	A-Nr	-
ISO 14172	E Ni 6620 (NiCr14Mo7Fe)	F-Nr	43
		9606 FM	6

GENERAL DESCRIPTION

Basic high recovery all position electrode for welding low temperature steels
 Recovery of approximately 150%, providing high deposition rates
 Especially developed for welding 9% Ni steel
 Linear expansion coefficient equivalent to that of 9% Ni steel
 Excellent impact toughness at -196°C, reliable 0.2%-Yield strength
 Weldable on AC as well as DC+ polarity
 Only available in vacuum sealed Sahara ReadyPack® (SRP)

WELDING POSITIONS (ISO/ASME)



PA/1G



PB/2F



PC/2G



PF/3Gu



PE/4G



PH/5Gu

CURRENT TYPE

AC / DC +

APPROVALS

GL TÜV

5680 +

CHEMICAL COMPOSITION (W%), TYPICAL, ALL WELD METAL

C	Mn	Si	Cr	Ni	Mo	Nb	Fe	W
0.05	3	0.4	13	bal.	6.0	1.5	6	1.5

MECHANICAL PROPERTIES, TYPICAL, ALL WELD METAL

Condition	0.2% Proof strength [N/mm ²]	Tensile strength [N/mm ²]	Elongation [%]	Impact ISO-V(J)	
				+20°C	-196°C
Required: AWS A5.11 ISO 14172 Typical values	not required min. 350 475	min. 620 min. 620 725	min. 20 min. 32 40	not required not required 100	90

PACKAGING AND AVAILABLE SIZES

SRP	Diameter (mm)	2.5	3.2	4.0
	Length (mm)	350	350	350
Pieces / unit	62	52	27	
Net weight/unit (kg)	1.7	2.2	1.8	

Identification Imprint: NiCrMo-6 / NYLOID 2 Tip Color: white

Nyloid 2 rev. C-EN25-01/02/16

All information in this data sheet is accurate to the best of our knowledge at the time of printing. Please refer to www.lincolnelectric.eu for any updated information. Fumes: Safety Data Sheets (SDS) are available on our website.

Nyloid 2

SMAW

EXAMPLES OF MATERIALS TO BE WELDED

Steel grades	EN 10028-4	Mat. Nr	ASTM	UNS
9% Ni steel for LNG storage tanks	X8Ni9	1.5662	A353/A353M	
	X8Ni9 (9% Ni)	1.5662	A553/A553M Type I	
	X8Ni9 (8% Ni)		A 553/A553M Type II	K71340
Low alloy steel for cryogenic applications	X12Ni5 (12Ni19)	1.5680		K41583
	10Ni14 (3.5% Ni)	1.5637	A333 Grade 3	
	12Ni14 (3.5% Ni)	1.5637	A203 Grade E	

CALCULATION DATA

Diam. x length [mm]	Current range [A]	Current type	Arc time	Energy	Dep. rate	Weight/ 1000 pcs [kg]	Electrodes/ kg weldmetal	kg electrodes/ kg weldmetal
			[S]*	E[kJ]	H[kg/h]		B	1/N
2.5 x 350	70-100	AC	54	128	1.3	26.5	53	1.39
3.2 x 350	85-145	AC	63	229	1.8	43.6	31	1.37
4.0 x 350	140-190	AC	73	355	2.4	65.8	21	1.33
5.0 x 450	180-280	AC	94	764	3.7	133.5	10	1.35

*Stub end 35mm

WELDING PARAMETERS, OPTIMUM FILL PASSES

Diameter [mm]	Welding positions					
	PA/1G	PB/2F	PC/2G	PF/3Gup	PE/4G	PH/5Gup
2.5	90 - 100A	90 - 100A	90 - 100A	90 - 100A	90 - 100A	80 - 100A
3.2	135 - 145A	135 - 145A	135 - 145A	125 - 135A	125 - 135A	120 - 135A
4.0	170 - 185A	170 - 185A	170 - 185A	140 - 165A		
5.0	220 - 270A	220 - 280A				

REMARKS / APPLICATION ADVICE

Recommended Heat-Input for plate thickness:

- ≤ 15 mm: 1.4 kJ/mm
- 15 - 20 mm: 1.6 kJ/mm
- > 20 mm: 2.0 kJ/mm

Nyloid 4

SMAW

CLASSIFICATION

AWS A5.11	ENiCrMo-6	A-Nr	-
ISO 14172	E Ni 6620 (NiCr14Mo7Fe)	F-Nr	43
		9606 FM	6

GENERAL DESCRIPTION

Basic high recovery all position electrode for welding low temperature steels
 Especially developed for performing in the PE/4G position (High resistance to porosity)
 Especially developed for welding 9% Ni steel
 Linear expansion coefficient equivalent to that of 9% Ni steel
 Excellent impact toughness at -196°C, reliable 0.2%-Yield strength
 Weldable on AC as well as DC+ polarity
 Only available in vacuum sealed Sahara ReadyPack® (SRP)

WELDING POSITIONS (ISO/ASME)

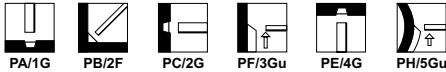

CURRENT TYPE

AC / DC +

APPROVALS

DNV	GL	BV
Pending	Pending	Pending

CHEMICAL COMPOSITION (W%), TYPICAL, ALL WELD METAL

C	Mn	Si	Cr	Ni	Mo	Nb	Fe	W
0.05	3.0	0.4	13	bal.	6.0	1.5	6.0	1.5

MECHANICAL PROPERTIES, TYPICAL, ALL WELD METAL

Condition	0.2% Proof strength [N/mm ²]	Tensile strength [N/mm ²]	Elongation [%]	Impact ISO-V(J)	
				+20°C	-196°C
Required: AWS A5.11 ISO 14172 Typical values	not required min. 350 490	min. 620 min. 620 770	min. 20 min. 32 33	100	min. 47 85

PACKAGING AND AVAILABLE SIZES

SRP	Diameter [mm]	2.5	3.2	4.0
	Length [mm]	300	300	350
Pieces / unit	69	36	30	
Net weight/unit [kg]	1.3	1.1	1.7	

Identification Imprint: NiCrMo-6 / NYLOID 4 Tip Color: Yellow

Nyloid 4: rev. C-EN02-01/02/16

All information in this data sheet is accurate to the best of our knowledge at the time of printing. Please refer to www.lincolnelectric.eu for any updated information.
 Fumes: Safety Data Sheets (SDS) are available on our website.

Nyloid 4

SMAW

EXAMPLES OF MATERIALS TO BE WELDED

Steel grades	EN 10028-4	Mat. Nr	ASTM/ICA	UNS
9%-Ni steel for LNG applications				
	X8Ni9	1.5662	A353/A353M NN+T	
	X8Ni9 (9% Ni)	1.5662	A553/A553M Type I	
	[8% Ni]		A553/A553M Type II	K71340
Low alloy steel for cryogenic applications				
	X12Ni5 (12Ni9)	1.5680		K41583
	10Ni14 (3.5% Ni)	1.5637	A333 Grade 3	
	12Ni14 (3.5% Ni)	1.5637	A203 Grade E	

CALCULATION DATA

Sizes Diam. x length [mm]	Current range [A]	Current type	Arc time - per electrode at max. current - [S]*	Energy E[kJ]	Dep. rate H[kg/h]	Electrodes/ kg weldmetal B	kg electrodes/ kg weldmetal 1/N
2.5 x 300	50-70	AC	52	88	0.9	77	1.47
3.2 x 300	70-110	AC	60	146	1.3	46	1.50
4.0 x 350	110-140	AC	75	234	1.9	25	1.41

*Stub end 35mm

WELDING PARAMETERS, OPTIMUM FILL PASSES

Diameter [mm]	Welding positions				
	PA/1G	PB/2F	PC/2G	PF/3Gup	PE/4G
2.5	60 - 70A	60 - 70A	55 - 70A	55 - 70A	55 - 65A
3.2	90 - 105A	90 - 105A	80 - 95A	70 - 90A	85 - 95A

REMARKS / APPLICATION ADVICE

Recommended heat-Input :

≤ 15 mm: 1.4 kJ/mm

15 - 20 mm: 1.6 kJ/mm

> 20 mm: 2.0 kJ/mm

AlMn

CLASSIFICATION

AWS A5.3	E3003*	F-Nr	21
ISO 18273	Al 3103 (AlMn1)	Mat-Nr	3.0516

*:Deviation,see remarks

GENERAL DESCRIPTION

Especially for welding forged and cast aluminium-magnesium alloys and aluminium-manganese alloys
Good weldability, no porosity

WELDING POSITIONS (ISO/ASME)



PA/1G



PB/2F



PF/3Gu

CURRENT TYPE

DC +

CHEMICAL COMPOSITION (W%), TYPICAL, ALL WELD METAL

Al	Mn	Si	Zn	Fe	Cu	Mg	Others
bal.	0.9-1.2	0.3 max.	0.09 max.	0.6 max.	0.02 max.	0.15 max	0.15 max.

MECHANICAL PROPERTIES, TYPICAL, ALL WELD METAL

	Condition	0.2% Proof strength (N/mm ²)	Tensile strength (N/mm ²)	Elongation (%)
Typical values	AW	40	110	20

PACKAGING AND AVAILABLE SIZES

	Diameter (mm)	2.5	3.2
	Length (mm)	350	350
Metal can	Pieces / unit	-	-
	Net weight/unit (kg)	2.0	2.0

AlMn: rev. C-EN24-12/05/16

AlMn

EXAMPLES OF MATERIALS TO BE WELDED

Aluminium manganese alloys and Aluminium magnesium alloys	Mat. Nr
AlMn1	3.0515
AlMn1Mg1	3.0526
AlMg1	3.3315

SMAW

CALCULATION DATA

Sizes Diam. x length (mm)	Current range (A)	Current type	Weight/ 1000 pcs (kg)
2.5 x 350	40-70	DC+	9.2
3.2 x 350	60-90	DC+	14.0

*Stub end 35mm

WELDING PARAMETERS, OPTIMUM FILL PASSES

Diameter (mm)	Welding positions		
	PA/1G	PB/2F	PF/3Gup
2.5	60A	60A	55A
3.2	80A	80A	75A

REMARKS / APPLICATION ADVICE

Deviations:chemical composition

Cu = max.0.02% AWS:Cu = 0.05 - 0.20%

Mn = 0.9 - 1.2% AWS:Mn = 1.0 - 1.5%

If the thickness is more than 10 mm, it is advisable to preheat at 150 - 250°C

AlSi5

CLASSIFICATION

AWS A5.3	E4043	F-Nr	23
ISO 18273	Al 4043A* [AlSi5(A)]	Mat-Nr	3.2245

*:Deviation,see remarks

GENERAL DESCRIPTION

Especially for welding forged and cast aluminium alloys containing less than 5% Si as main alloying element
Good weldability, no porosity

WELDING POSITIONS (ISO/ASME)



PA/1G



PB/2F



PF/3Gu

CURRENT TYPE

DC +

CHEMICAL COMPOSITION (W%), TYPICAL, ALL WELD METAL

Al	Si
bal.	5.0

MECHANICAL PROPERTIES, TYPICAL, ALL WELD METAL

	Condition	0.2% Proof strength [N/mm ²]	Tensile strength [N/mm ²]	Elongation [%]
Typical values	AW	90	160	15

PACKAGING AND AVAILABLE SIZES

	Diameter [mm]	2.5	3.2	4.0
Length [mm]		350	350	350
Metal can	Pieces / unit	-	-	-
	Net weight/unit [kg]	2.0	2.0	2.0

AlSi5: rev. C-EN23-12/05/16

AlSi5

EXAMPLES OF MATERIALS TO BE WELDED

Aluminium-silicon alloys and dissimilar of several aluminium alloys.

With restriction : precipitation hardening alloys such as :

	Mat. Nr
AlCuMg1	3.1325
AlMgSi1	3.2315
AlZn4.5Mg1	3.4335

SMAW

CALCULATION DATA

Sizes Diam. x length (mm)	Current range (A)	Current type	Weight/ 1000 pcs (kg)
2.5 x 350	40-70	DC+	9.2
3.2 x 350	60-90	DC+	14.0
4.0 x 350	80-120	DC+	20.4

*Stub end 35mm

WELDING PARAMETERS, OPTIMUM FILL PASSES

Diameter (mm)	Welding positions		
	PA/1G	PB/2F	PF/3Gup
2.5	60A	60A	55A
3.2	80A	80A	75A
4.0	110A	110A	105A

REMARKS / APPLICATION ADVICE

If the thickness is more than 10 mm, it is advisable to preheat at 150 - 250°C

Welding with short arc preferable

Electrode with 90°angle on material

AlSi12

CLASSIFICATION

ISO 18273 Al 4047A (AlSi12(A)) F-Nr 23*
 *:Deviation, see remarks Mat-Nr 3.2585

GENERAL DESCRIPTION

Especially for welding forged and cast aluminium alloys containing more than 7% Si as main alloying element
 Also applicable as surfacing electrode
 Good weldability, no porosity
 Applicable when Al-properties are unknown

WELDING POSITIONS (ISO/ASME)



PA/1G



PB/2F



PF/3Gu

CURRENT TYPE

DC +

CHEMICAL COMPOSITION (W%), TYPICAL, ALL WELD METAL

Al	Si
bal.	12.0

MECHANICAL PROPERTIES, TYPICAL, ALL WELD METAL

	Condition	0.2% Proof strength (N/mm ²)	Tensile strength (N/mm ²)	Elongation (%)
Typical values	AW	80	180	5

PACKAGING AND AVAILABLE SIZES

	Diameter (mm)	2.5	3.2	4.0
	Length (mm)	350	350	350
Metal can	Pieces / unit	-	-	-
	Net weight/unit (kg)	2.0	2.0	2.0

AlSi12; rev. C-EN23-12/05/16

AlSi12

EXAMPLES OF MATERIALS TO BE WELDED

Aluminium cast alloys with silicon level up to approx. 12%, like	Mat. Nr
G-AISI 10Mg	3.2381
G-AISI 12	3.2581

CALCULATION DATA

Sizes Diam. x length (mm)	Current range (A)	Current type	Weight/ 1000 pcs (kg)
2.5 x 350	40-70	DC+	8.8
3.2 x 350	60-90	DC+	13.2
4.0 x 350	80-120	DC+	19.6

*Stub end 35mm

WELDING PARAMETERS, OPTIMUM FILL PASSES

Diameter (mm)	Welding positions		
	PA/1G	PB/2F	PF/3Gup
2.5	60A	60A	55A
3.2	80A	80A	75A
4.0	110A	110A	105A

REMARKS / APPLICATION ADVICE

If the thickness is more than 15 mm, it is advisable to preheat at 150 - 250°C
 Welding with short arc preferable
 Electrode with 90°angle on material

Wearshield® BU-30

CLASSIFICATION

DIN 8555 E1-UM-350-GP
EN 14700 E Fe1

GENERAL DESCRIPTION

Can be used both downhand and out of position, although the flat position is preferred
Arc characteristics are excellent with very low spatter levels
The electrode coating permits the use of the drag or contact welding technique
Good arc restriking

WELDING POSITIONS (ISO/ASME) (ISO/ASME)



PA/1G



PB/2F



PC/2G



PF/3Gu



PE/4G



PH/5Gu

CURRENT TYPE

AC / DC +

CHEMICAL COMPOSITION (W%), TYPICAL, ALL WELD METAL

C	Mn	Si	Cr	Mo
0.2	0.8	1.0	1.5	0.5

STRUCTURE

In the as welded condition the microstructure consists mainly of martensite with some bainite

MECHANICAL PROPERTIES, TYPICAL, ALL WELD METAL

Typical hardness values

1 Layer 31 HRC (295 HB)
2 Layers 35 HRC (330 HB)
3 Layers 38 HRC (350 HB)
Welded on Mild Steel Plate

PACKAGING AND AVAILABLE SIZES

	Diameter (mm)	3.2	4.0	5.0
	Length (mm)	350	350	450
PE-Tube	Pieces / unit	65	44	23
	Net weight/unit (kg)	2.5	2.5	2.5

Identification Imprint: WEARSHIELD BU-30 Tip Color: black

Wearshield®BU-30:rev.C-EN24-01/02/16

Wearshield® BU-30

APPLICATION

Wearshield BU-30 produces a crack-free wear resistant deposit with a hardness of 31-38 HRc (295-350 HB) depending on dilution and number of layers. It is particularly suitable under conditions of moderate abrasion and friction, combined with resistance to impact. Ideally suitable for applications involving rolling, sliding and metal to metal wear. It may also be used as a final overlay on parts which need to be machined or as a build-up layer for other hardfacing materials.

Typical applications include:

Buildup:

Shovel and bucket lips

Pump impellers and housings

Dredge and shovel bucket teeth

Mill and crushing hammers

Hardfacing:

Crane and mine car wheels

Tractor rolls, idlers, links and sprockets

Cable drums

Roller guides

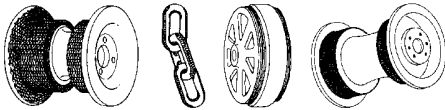

ADDITIONAL INFORMATION

When welding with Wearshield BU-30, DC+ is preferred for most applications, although AC provides satisfactory results too. The bead width should be limited to between 12 - 20mm for all electrode diameters when applying a weaving technique. Narrow stringer beads are preferred for edge and corner buildup.

All work-hardened base material should be removed prior to applying Wearshield BU-30 in order to prevent embrittlement and cracking.

A preheat and interpass temperature of 150-250°C is necessary to prevent cracking, especially on large complex or high restrained components. The component should be completed without interruptions, however, if interruptions are unavoidable the component should be preheated again prior to welding.

The deposited weld metal can be machined to exact dimensions using high speed or carbide cutting tools.

There is no limit to the deposit build-up with this electrode.

Wearshield BU-30 exhibits good resistance to spalling and peeling and moderate resistance to gouging and galling. If gouging is severe then Wearshield Mangjet or Wearshield 15CrMn would be more appropriate because of the higher work hardening effect. If galling is more severe then Wearshield MM or Wearshield MM 40 would be preferred.

CALCULATION DATA

Sizes		Current range [A]	Current type	Arc time - per electrode at max. current - [S]*	Energy E[kJ]	Dep. rate H[kg/h]	Weight/ 1000 pcs [kg]	Electrodes/ kg weldmetal B	kg electrodes/ kg weldmetal 1/N
Diam. x length [mm]									
3.2 x 350	90-130	DC+	62	229	1.3	371	44	1.64	
4.0 x 350	140-180	DC+	63	338	1.8	54.4	32	1.72	
5.0 x 450	180-260	DC+	99	616	2.6	108.8	14	1.54	

COMPLEMENTARY PRODUCTS

Lincore® 33

Wearshield® Mangjet (e)

CLASSIFICATION

AWS A5.13	EFeMn-A	F-Nr	71
DIN 8555	E7-UM-200-KP		
EN 14700	E Fe9		

GENERAL DESCRIPTION

A low hydrogen hardfacing electrode designed for heavy impact properties
 Exhibits excellent arc striking characteristics, clean slag detachability and low spatter
 The electrode coating permits out of position welding
 140% recovery

WELDING POSITIONS (ISO/ASME)



PA/1G



PB/2F



PC/2G



PF/3Gu



PE/4G

CURRENT TYPE

AC / DC + / -

CHEMICAL COMPOSITION (W%), TYPICAL, ALL WELD METAL

C	Mn	Cr
0.7	15	3.7

STRUCTURE

In the as deposited condition, the microstructure consists of a soft manganese alloy austenite which rapidly work hardens under impact loading.

MECHANICAL PROPERTIES, TYPICAL, ALL WELD METAL

Typical hardness values

As deposited	18 HRC (210 HB)
Work hardened	47 HRC (450 HB)

PACKAGING AND AVAILABLE SIZES

	Diameter (mm)	3.2	4.0
	Length (mm)	350	450
PE-Tube	Pieces / unit	53	24
	Net weight/unit (kg)	2.5	2.5

Identification Imprint: WEARSHIELD Mangjet Tip Color: violet

Wearshield® Mangjet: rev. C-EN24-01/02/16

Wearshield® Mangjet (e)

APPLICATION

Wearshield Mangjet produces a 14% Mn deposit that rapidly work hardens under heavy impact and battering. Ideally suited for applications to high impact and gouging coupled with moderate abrasion.

Typical applications include:

- Jaw and cone crushers
- Heavy rock moving plant
- Hammer drills
- Crusher screens
- Dredge parts
- Shovel tracks
- Rail crossovers, frogs and switches

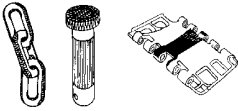

SMAW

ADDITIONAL INFORMATION

When welding with Wearshield Mangjet, DC+ is preferred for most applications especially positional work, although AC and DC - are also satisfactory. The weld width should be limited to 12-20mm for all electrode diameters when employing a weaving technique. Narrow stringer beads are preferred for edge and corner buildup.

All work-hardened base material and previously deposited material should be removed prior to applying a new deposit, since such areas are prone to embrittlement and possible cracking.

No preheat is required on austenitic manganese steels although a preheat of between 150-200°C may be necessary on carbon and low alloy steels to prevent pullout.

It is important to avoid excessive heat build up in the base material. Temperatures above 260°C should be avoided as this can cause embrittlement.

For joint welding of manganese steel Wearshield 15CrMn or Jungo 307 are preferred. Small thickness can be welded with Arosta 307 as well. There is no definite limitation to the number of passes that may be deposited, however, it is good practise to peen each pass immediately after welding to minimise internal stresses and possible distortion and cracking.

CALCULATION DATA

Sizes Diam. x length (mm)	Current range (A)	Current type	Dep. rate H(kg/h)
3.2 x 350	95-105	DC+	1.1
4.0 x 350	130-140	DC+	1.6

COMPLEMENTARY PRODUCTS

Lincore® M
Wire/flux combination : Lincore M / 801 or 802

Wearshield® 15CrMn

SMAW

CLASSIFICATION

DIN 8555 E7-UM-250-KP
EN 14700 E Fe9

GENERAL DESCRIPTION

A rutile hardfacing electrode designed for applications of light impact wear, high gouging wear
Easy slag detachability, good arc restriking and low spatter
The electrode coating permits out of position welding
Designed for applications of high impact wear and high gouging wear
Gives moderate abrasion resistance

WELDING POSITIONS (ISO/ASME)



PA/1G



PB/2F



PC/2G



PF/3Gu



PE/4G

CURRENT TYPE

AC / DC +

CHEMICAL COMPOSITION (W%), TYPICAL, ALL WELD METAL

C	Mn	Si	Cr
0.35	14	0.6	15

STRUCTURE

In the as deposited condition, the microstructure consists of a soft manganese alloy austenite which rapidly work hardens under impact loading.

MECHANICAL PROPERTIES, TYPICAL, ALL WELD METAL

Typical hardness values

As deposited 18 - 24 HRC (210-250 HB)
Work hardened 40 - 50 HRC (375-490 HB)

PACKAGING AND AVAILABLE SIZES

	Diameter (mm)	3.2	4.0	4.8
	Length (mm)	355	355	455
PE-Tube	Pieces / unit	49	33	24
	Net weight/unit (kg)	2.5	2.5	2.5

Identification Imprint: WEARSHIELD 15CrMn Tip Color: none

Wearshield® 15CrMn; rev. C-EN24-01/02/16

All information in this data sheet is accurate to the best of our knowledge at the time of printing. Please refer to www.lincolnelectric.eu for any updated information.
Fumes: Safety Data Sheets (SDS) are available on our website.

Wearshield® 15CrMn

APPLICATION

Wearshield 15CrMn produces a premium austenitic chromium-manganese deposit. The term premium is used because the weld metal has sufficient alloy content to produce a single pass austenitic deposit on ordinary carbon steel. The deposit rapidly work hardens under impact making it particularly suitable for applications of high impact and gouging, coupled with moderate abrasion. In addition to surfacing, the high crack resistance of this alloy design makes Wearshield 15CrMn an ideal electrode for joining manganese steel to itself or carbon steels with minimal risk of centreline cracking.

Typical applications include:

- Railroad frogs
- Track ends
- Crusher hammers and screens
- Earth moving equipment
- Rebuilding of austenitic manganese plates and components
- Construction equipment

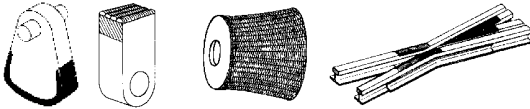

ADDITIONAL INFORMATION

When welding with Wearshield 15CrMn a short arc or contact drag technique is preferred. The weld width should be limited to 12-20mm for all electrode diameters. Narrow stringer beads are preferred for edge and corner build up.

All work-hardened base material and previously deposited material should be removed prior to applying a new deposit, since such areas are prone to embrittlement and possible cracking.

No preheat is required on austenitic manganese steels although a preheat of between 150-200°C may be necessary on carbon and low steels to prevent heat affected zone cracking.

It is important to avoid excessive heat build up in the base material. High heat input welds and interpass temperatures above 260°C should be avoided as this can cause embrittlement.

There is no definite limitation to the number of passes that may be deposited, however, it is good practise to peen each pass immediately after welding to minimise internal stresses and possible distortion and cracking.

Wearshield 15CrMn deposits workharden rapidly making them difficult to machine. For best results carbide or ceramic cutting tools and rigid tooling should be used. Grinding can also be successfully employed.

For applications involving severe impact and abrasion, a buildup of Wearshield 15CrMn coupled with a single pass of Wearshield 60 or Lincore 60-0 should be employed.

The Wearshield 15CrMn deposit can not be cut using the Oxy-fuel process due to the high chromium content, however, plasma arc and air carbon arc processes are appropriately.

CALCULATION DATA

Sizes		Current range (A)
Diam. x length (mm)		
3.2 x 355		140-160
4.0 x 355		130-140
4.8 x 455		220-250

COMPLEMENTARY PRODUCTS

Lincore® 15CrMn

Wearshield® MM 40

CLASSIFICATION

DIN 8555 E1-UM-400-G*

EN 14700 E Fe1

* Nearest classification

GENERAL DESCRIPTION

An all position rutile/basic coated electrode that produces a machinable martensitic deposit if weld metal is not quenched
Designed for rolling, sliding and metal to metal wear resistance

Good restriking and low spatter

The electrode can be used with the drag or contact welding technique as well as out of position

WELDING POSITIONS (ISO/ASME)



PA/1G



PC/2G



PH/5Gu

CURRENT TYPE

AC / DC +

CHEMICAL COMPOSITION (W%), TYPICAL, ALL WELD METAL

C	Mn	Si	Cr	Mo
0.2	0.5	1.3	3.4	0.5

STRUCTURE

In the as welded condition the microstructure consists mainly of martensite

MECHANICAL PROPERTIES, TYPICAL, ALL WELD METAL

Typical hardness values

1 Layer	39-42 HRc (360-400 HB)
2 Layers	40-45 HRc (375-425 HB)
3 Layers	42-45 HRc (400-425 HB)

Welded on Mild Steel Plate

PACKAGING AND AVAILABLE SIZES

	Diameter (mm)	3.2	4.0	5.0
	Length (mm)	350	350	450
PE-Tube	Pieces / unit	66	43	22
	Net weight/unit (kg)	2.5	2.5	2.5

Identification Imprint: WEARSHIELD MM40 Tip Color: red

Wearshield® MM40: rev. C-EN24-01/02/16

Wearshield® MM 40

APPLICATION

Wearshield MM 40 produces a crack-free wear resistant deposit with a hardness of 42-45 HRC depending on upon material dilution and number of layers. It is particularly suitable for applications involving sliding, rolling and metal to metal wear, combined with resistance to mild abrasion.

Typical applications include:

- Buckets links, bucket bases
- Guide rolls
- Tractor rolls
- Crane wheels

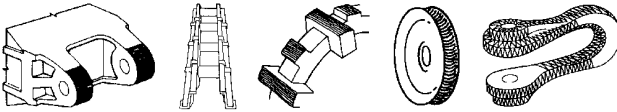

ADDITIONAL INFORMATION

When welding with Wearshield MM 40 the bead width should be limited to 12 - 20mm for all electrode diameters when using a weaving technique. For edge and corner build-up narrow stringer beads are preferred. A preheat between 150-250°C is necessary to prevent cracking in situations of high restraint and/or heavy thicknesses.

The deposited weld metal is machinable, therefore, tempering and annealing are not generally necessary but may be carried out to decrease hardness and increase toughness. Annealing at 760°C for several hours and slow cooling followed by tempering at 520°C will reduce the hardness. This deposit can subsequently be flame hardened or furnace hardened.

The build up is usually limited to 4 layers.

CALCULATION DATA

Sizes Diam. x length (mm)	Current range (A)	Current type	Arc time	Energy	Dep. rate	Weight/ 1000 pcs (kg)	Electrodes/ kg weldmetal	kg electrodes/ kg weldmetal
			- per electrode at max. current - (S)*	E(kJ)	H(kg/h)		B	1/N
3.2 x 350	90-130	DC+	71	175	1.3	36.6	41	1.57
4.0 x 350	140-180	DC+	83	312	1.5	56.6	28	1.61
5.0 x 450	170-220	DC+	108	640	2.5	114.1	13	1.50

COMPLEMENTARY PRODUCTS

Lincore® 40-0

Wearshield[®] MM

CLASSIFICATION

DIN 8555 E2-UM-55-G*
EN 14700 E Fe2

* Nearest classification

GENERAL DESCRIPTION

An all position rutile/basic coated electrode that produces a non machinable martensitic deposit (only by grinding)
Designed for rolling, sliding and metal to metal wear resistance
Good restriking and low spatter
The electrode can be used with the drag or contact welding technique as well as out of position

WELDING POSITIONS (ISO/ASME)



PA/1G



PB/2F



PC/2G



PF/3Gu



PE/4G



PH/5Gu

CURRENT TYPE

AC / DC +

CHEMICAL COMPOSITION (W%), TYPICAL, ALL WELD METAL

C	Mn	Si	Cr	Mo	W
0.55	0.5	1.5	4.5	0.5	0.5

STRUCTURE

In the as welded condition the microstructure consists mainly of martensite with carbides.

MECHANICAL PROPERTIES, TYPICAL, ALL WELD METAL

Typical hardness values

1 Layer 45-55 HRc
2 Layers 52-57 HRc

Welded on Mild Steel Plate

PACKAGING AND AVAILABLE SIZES

	Diameter (mm)	3.2	4.0	5.0
	Length (mm)	350	350	450
PE-Tube	Pieces / unit	66	45	22
	Net weight/unit (kg)	2.5	2.5	2.5
Linc Pack	Pieces / unit	26	18	-
	Net weight/unit (kg)	1.0	1.0	-

Identification Imprint: WEARSHIELD MM Tip Color: purple

Wearshield[®] MM: rev. C-EN24-01/02/16

All information in this data sheet is accurate to the best of our knowledge at the time of printing. Please refer to www.lincolnelectric.eu for any updated information.
Fumes: Safety Data Sheets (SDS) are available on our website.

Wearshield® MM

APPLICATION

Wearshield MM produces a crack-free wear resistant deposit with a hardness of 55-57 Rc depending on dilution and number of layers. It is particularly suitable for applications involving sliding, rolling and metal to metal wear, combined with resistance to mild abrasion.

Typical applications include:

- Crane and mine car wheels
- Sprockets and gear teeth
- Skip guides
- Dredger buckets
- Scraper blades
- Transfer tables
- Cable sheaves

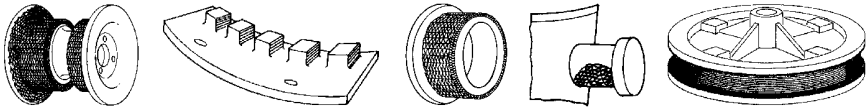

ADDITIONAL INFORMATION

When welding with Wearshield MM the bead width should be limited to 12 - 20mm for all electrode diameters when using a weaving technique. For edge and corner buildup narrow stringer beads are preferred. A preheat between 200-350°C is necessary to prevent cracking with interpass temperatures of up to 400°C in situations of high restraint and/or heavy thicknesses. After welding the component should be covered and slowly cooled.

The deposited weld metal is not machinable by conventional methods although the deposit can be shaped by grinding.

The deposit can be tempered at about 425°C to toughen the weld metal resulting in a hardness of approximately 50 HRC. Annealing at 760°C for several hours and slow cooling will reduce the hardness to approximately 30 HRC. This deposit can be readily machined. Rehardening is achieved by heating to about 950°C for several hours to dissolve all carbides and homogenise the structure, followed by either water or oil quench (thin sections may be air cooled). After quenching the component should be tempered.

Flame hardening is also possible after annealing, although full hardness may not be achieved due to the inability to homogenize the steel in the short heating cycle.

The build up is usually limited to 4 layers.

CALCULATION DATA

Sizes		Current range (A)	Current type	Arc time - per electrode at max. current - (S)*	Energy E(kJ)	Dep. rate H(kg/h)	Weight/ 1000 pcs (kg)	Electrodes/ kg weldmetal B	kg electrodes/ kg weldmetal 1/N
Diam. x length (mm)									
3.2 x 350	90-130	DC+	75	186	1.2	39.0	42	1.62	
4.0 x 350	140-180	DC+	87	343	1.4	55.8	30	1.65	
5.0 x 450	170-220	DC+	112	516	2.3	115.2	14	1.62	

COMPLEMENTARY PRODUCTS

Lincore® 55

Wearshield® T&D

CLASSIFICATION

AWS A5.13	E Fe6*	F-Nr	71
DIN 8555	E4-UM-60-SZ		
EN 14700	E Fe4		

* Nearest classification

GENERAL DESCRIPTION

A basic coated electrode that produces a high speed steel deposit similar to M-1 tool steel
 The deposited weld metal is air hardening
 Resists metal-to-metal abrasion
 Excellent arc characteristics, good restriking, low spatter and weld quality
 The electrode coating permits the use of the drag or contact welding technique

WELDING POSITIONS (ISO/ASME)



PA/1G

CURRENT TYPE

AC / DC +

CHEMICAL COMPOSITION (W%), TYPICAL, ALL WELD METAL

C	Mn	Si	Cr	Mo	W	V
0.65	0.4	0.5	4.0	6.5	2.6	1.1

STRUCTURE

In the as welded condition the microstructure consists mainly of martensite with some carbides.
 After tempering the microstructure consists of tempered martensite with secondary carbides

MECHANICAL PROPERTIES, TYPICAL, ALL WELD METAL

Typical hardness values

As Welded	58-62 HRC
Tempered at 540-600°C	63-65 HRC
Welded on Mild Steel Plate (12mm)	

PACKAGING AND AVAILABLE SIZES

	Diameter (mm)	2.5	3.2	4.0
	Length (mm)	350	350	350
PE-Tube	Pieces / unit	85	56	35
	Net weight/unit (kg)	2.5	2.5	2.5

Identification Imprint: WEARSHIELD T&D Tip Color: none

Wearshield® T&D: rev. C-EN24-01/02/16

All information in this data sheet is accurate to the best of our knowledge at the time of printing. Please refer to www.lincolnelectric.eu for any updated information.
 Fumes: Safety Data Sheets (SDS) are available on our website.

Wearshield® T&D

APPLICATION

Wearshield T&D produces a crack-free wear resistant tool steel deposit with a hardness of 58-62 HRC. This hardness can be further increased to between 63-65HRC after tempering (540-600°C). It is particularly suitable for applications involving severe metal to metal wear coupled with elevated temperatures (up to 540°C). Ideally suited to the buildup of worn steel dies, cutting tools or the applications of wear resistant surfaces to carbon and low alloy steels.

Typical applications include:

- Punch and forging dies
- Shear blades
- Trimmers
- Cutting tools

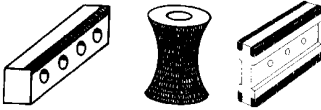

ADDITIONAL INFORMATION

When welding with Wearshield T&D the weld width should be limited to between 12 - 25mm for all electrode diameters when employing a weaving technique. For edge and corner buildup narrow stringer beads are preferred. A preheat and interpass temperature of 325°C, or higher (up to 540°C), is necessary to avoid cracking. It is important to ensure that an adequate "soak" is achieved prior to the welding operation. After welding, the component should be covered and slow cooled down to room temperature. Once cooled, the deposited weldment should be post weld heat treated to temper the martensite and toughen the deposit. Tempering at 540-600°C normally produces the optimum combination of hardness and toughness.

The deposited weld metal is not machinable by conventional methods although the deposit can be shaped by grinding.

Annealing at 850°C for several hours and slow cooling will reduce the hardness to approximately 30 HRc. This deposit can be readily machined. Rehardening is achieved by heating to about 1200°C for several hours to dissolve all carbides and homogenise the steel, followed by air cooling and tempering (540-600°C).

The deposit thickness is usually limited to 4 layers.

Wearshield T&D cannot be cut by the oxy-fuel processes. Plasma arc and air-carbon arc processes can be used to both cut and gouge the weld deposit. Preheat temperature similar to those for welding may be necessary to prevent cracking along the cut edge.

CALCULATION DATA

Sizes		Current range (A)
Diam. x length (mm)		
2.5 x 350	80-100	
3.2 x 350	110-130	
4.0 x 350	130-160	

COMPLEMENTARY PRODUCTS

Lincore® T&D

Wearshield® MI (E)

CLASSIFICATION

AWS A5.13	E Fe6
DIN 8555	E6-UM-60-GPS
EN 14700	E Fe6

GENERAL DESCRIPTION

A basic coated electrode that produces a martensitic deposit with a considerable amount of retained austenite
 All position welding, except vertical down
 Excellent arc characteristics, good restriking, low spatter and weld quality
 Designed for applications with impact and metal-to-metal wear

WELDING POSITIONS (ISO/ASME)



PA/1G



PB/2F



PC/2G



PF/3Gu



PE/4G



PH/5Gu

CURRENT TYPE

AC / DC -

CHEMICAL COMPOSITION (W%), TYPICAL, ALL WELD METAL

C	Mn	Si	Cr
0.5	0.4	1.8	9.0

STRUCTURE

In the as welded condition the microstructure consists of a mixed structure of martensite and austenite.

MECHANICAL PROPERTIES, TYPICAL, ALL WELD METAL

Typical hardness values

1 Layer	45-55 HRc
2 Layers	50-58 HRc
Welded on Mild Steel Plate	

PWHT : 4H/480°C / 52HRc

PACKAGING AND AVAILABLE SIZES

		Diameter (mm)			
		2.5	3.2	4.0	5.0
	Length (mm)	350	350	450	450
PE-Tube	Pieces / unit	117	69	38	25
	Net weight/unit (kg)	2.5	2.5	2.5	2.5

Identification Imprint: WEARSHIELD MI (E) Tip Color: violet

Wearshield® MI (E): rev. C-EN24-01/02/16

All information in this data sheet is accurate to the best of our knowledge at the time of printing. Please refer to www.lincolnelectric.eu for any updated information.
 Fumes: Safety Data Sheets (SDS) are available on our website.

Wearshield® MI (e)

APPLICATION

Wearshield MI produces a wear resistant martensite/austenite deposit with a hardness of 45-58 HRC. It can be used to surface a variety of carbon, carbon manganese and alloy steels. The martensite/austenite deposit makes Wearshield MI particularly suitable for Applications involving impact, metal to metal wear and mild abrasion such as by limestone. This deposit tends to cross check.

Typical applications include:

- Dipper lips
- Construction equipment
- Earth moving equipment
- Rock crushers
- Hammer mills
- Conveyor screws
- Ditcher teeth
- Agricultural equipment

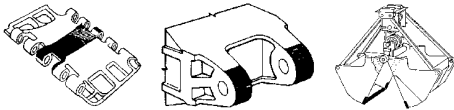

ADDITIONAL INFORMATION

A preheat and interpass temperature of over 200°C is preferred to help reduce check cracking and avoid chipping and fragmentation.

The deposited weld metal is not machinable by conventional methods although the deposit can be shaped by grinding.

The Wearshield MI deposit tends to cross check and is therefore usually limited to 2 layers to avoid chipping and fragmentation.

Wearshield MI cannot be cut by the oxy-fuel processes. Plasma arc and air-carbon arc processes can be used to both cut and gouge the weld deposit.

CALCULATION DATA

Sizes		Dep. rate
Diam. x length (mm)	Current range (A)	H(kg/h)
2.5 x 350	60-70	0.76
3.2 x 350	70-120	1.1
4.0 x 350	110-150	1.45
5.0 x 450	150-200	2.0

COMPLEMENTARY PRODUCTS

Solid wire LNM 420 FM and flux-cored wire Lincore 420

Wearshield® ABR

CLASSIFICATION

DIN 8555 : E10-UM-50-GPZ
EN 14700 : E Fe6

GENERAL DESCRIPTION

A graphite coated electrode that produces a primary austenite and austenite-eutectic weld deposit. Wearshield ABR is the most versatile product within the Wearshield range
Good resistance to both abrasion and impact, as well as hot-forging properties

WELDING POSITIONS (ISO/ASME)



PA/1G



PB/2F



PC/2G



PF/3Gu

CURRENT TYPE

AC / DC + / -

CHEMICAL COMPOSITION (W%), TYPICAL, ALL WELD METAL

C	Mn	Si	Cr	Mo
2.1	1.1	0.75	6.5	0.40

STRUCTURE

In the as welded condition the microstructure consists of primary austenite and a eutectic of austenite plus carbides

MECHANICAL PROPERTIES, TYPICAL, ALL WELD METAL

Typical hardness values

1 Layer	24-53 HRC
2 Layers	28-53 HRC
3 Layers	28-55 HRC
Welded on Mild Steel Plate	

PACKAGING AND AVAILABLE SIZES

	Diameter (mm)	3.2	4.0	4.8
	Length (mm)	355	355	355
PE-Tube	Pieces / unit	85	54	38
	Net weight/unit (kg)	2.5	2.5	2.5

Identification Imprint: WEARSHIELD ABR Tip Color: none

Wearshield® ABR: rev. C-EN23-01/02/16

All information in this data sheet is accurate to the best of our knowledge at the time of printing. Please refer to www.lincolnelectric.eu for any updated information.
Fumes: Safety Data Sheets (SDS) are available on our website.

Wearshield® ABR

APPLICATION

Wearshield ABR produces an abrasion and impact resistant deposit with a hardness of 28-55HRC depending on base metal chemistry, dilution and number of layers. The combination of abrasion and impact resistance coupled with hot forging properties makes Wearshield ABR particularly suitable for applications involving transportation of abrasive media under heavy variable loading. Wearshield ABR is also suitable for metal to metal wear applications.

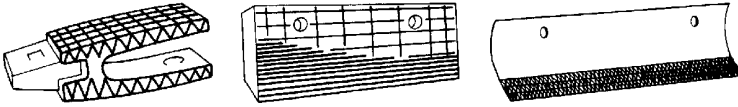

SMAW

ADDITIONAL INFORMATION

When welding with Wearshield ABR a short arc should be employed. The weld width should be limited to between 12-20mm for all electrode diameters when employing a weaving technique. For edge and corner build up narrow stringer beads are preferred.

Preheat is not necessary when surfacing austenitic substrates such as stainless and manganese steels, although the interpass temperature should be limited to about 260°C for manganese steels. For low alloy and carbon steels a preheat of 200°C is usually sufficient, but is dependent on material thickness and chemistry. For optimum abrasion resistance the interpass temperature should be limited to 320°C.

The deposited weld metal is not machinable by conventional methods although the deposit can be shaped by grinding.

To obtain a deposit that can be machined by carbide cutting tools, the component should be heated to 750°C for one hour followed by air cooling to room temperature. For maximum machinability the component should be heated to 875-900°C for one hour, furnace cooled to 650°C at a rate not exceeding 10°C per hour, followed by furnace or air cooling to room temperature. The abrasion resistance can be restored by heating to 800°C, quenching and tempering at 200°C.

The deposit thickness is usually limited to 2 layers.

For applications requiring thicker deposits, an intermediate layer of an austenitic material such as Wearshield 15CrMn should be used and each layer peened to relieve residual stresses.

For maximum resistance to spalling one or more layers of Wearshield 15CrMn should be used as buildup.

There is no flux cored equivalent to Wearshield ABR.

CALCULATION DATA

Sizes	
Diam. x length [mm]	Current range [A]
3.2 x 355	40 - 150
4.0 x 355	75-200
4.8 x 355	110-250

COMPLEMENTARY PRODUCTS

The closest product is Lincore® 50, however, the deposit varies significantly to Wearshield ABR.

Wearshield® ME (e)

CLASSIFICATION

DIN 8555 E10-UM-60-GRZ
EN 14700 E Fe14

GENERAL DESCRIPTION

A heavily coated rutile electrode that produces a near eutectic mix of chromium carbides and austenite, with limited primary carbides
Weld deposit 170% recovery
Designed for metal to earth application to provide abrasion resistance
The electrode coating permits the use of a light drag or contact welding technique.

WELDING POSITIONS (ISO/ASME)



PA/1G



PB/2F

CURRENT TYPE

AC / DC +

CHEMICAL COMPOSITION (W%), TYPICAL, ALL WELD METAL

C	Cr	Si
3.0	33.0	1.0

STRUCTURE

In the as welded condition the microstructure consists of a near eutectic mix of chromium carbides and austenite, with limited primary carbides

MECHANICAL PROPERTIES, TYPICAL, ALL WELD METAL

Typical hardness values

1 Layer 55 HRc
2 Layers 60 HRc
Welded on Mild Steel Plate

PACKAGING AND AVAILABLE SIZES

		Diameter (mm)		
		3.2	4.0	5.0
	Length (mm)	450	450	450
PE-Tube	Pieces / unit	37	23	15
	Net weight/unit (kg)	2.5	2.5	2.5

Identification Imprint: WEARSHIELD ME (E) Tip Color: violet

Wearshield® ME (E): rev. C-EN25-01/02/16

All information in this data sheet is accurate to the best of our knowledge at the time of printing. Please refer to www.lincolnelectric.eu for any updated information.
Fumes: Safety Data Sheets (SDS) are available on our website.

Wearshield® ME (e)

APPLICATION

Wearshield ME produces an abrasion resistant deposit with a hardness range of 55-60HRc. The intended use of Wearshield ME is to provide a combination of abrasion and impact resistance at service temperatures up to 600°C.

Typical applications include:

- Ingot tongs
- Scrapper blades
- Rolling mill guides
- Screw flights
- Coal mining chutes
- Plough shares, scrapper blades and cultivator sweeps
- Pulleys and chain links

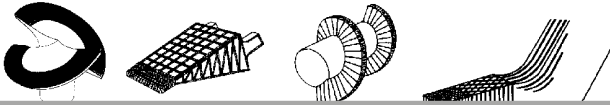

ADDITIONAL INFORMATION

When welding with Wearshield ME the weld width should be limited to 20mm. Since wide weaves generally increase the check crack spacing which can result in deposit spalling on multiple layers. For edge, corner and general buildup, narrow stringer beads are preferred.

Wearshield ME generally check cracks except for single layers on thin base material. Stringer beads tend to produce a consistent crack spacing of between 12-25mm.

Preheat is not necessary when surfacing austenitic substrates such as stainless steels and manganese steels, although the interpass temperature should be limited to about 260°C for manganese steels, For low alloy and carbon steels a preheat of 200°C is usually sufficient, but is dependent on base material thickness and chemistry. The deposited weld metal is not machinable by conventional methods although the deposit can be shaped by grinding. The deposit thickness is usually limited to 2-3 layers to avoid spalling.

To minimise the risk of spalling, stringer beads should be employed to produce closely spaced check cracks.

The resultant weld metal microstructure is determined by the level of dilution and base material chemistry. Low dilution welds on carbon and low alloy steels results in a microstructure that is a near eutectic mix of chromium carbides and austenite, with limited primary carbides. High dilution weld deposit produce a microstructure of primary austenite and eutectic resulting in higher toughness and lower abrasion resistance.

For maximum spalling resistance on carbon and low alloy steels, a buffer layer of Wearshield MM 40 or Arosta 307-160 should be applied prior to the Wearshield ME.

CALCULATION DATA

Sizes		Current range (A)	Current type	Dep. rate
Diam. x length (mm)	H(kg/h)			
3.2 x 450	100-140	DC+	1.15	
4.0 x 450	130-190	DC+	1.70	
5.0 x 450	160-260	DC+	2.25	

COMPLEMENTARY PRODUCTS

There is no flux cored equivalent to Wearshield ME. The closest product is Lincore® 60-O, however, the deposit varies significantly to Wearshield ME.

Wearshield® 60 (e)

CLASSIFICATION

DIN 8555 E10-UM-60-GR
EN 14700 E Fe15

GENERAL DESCRIPTION

A basic coated downhand 200% recovery electrode that produces a primary carbide weld deposit
The electrode coating facilitates easy arc control and arc visibility whilst maintaining a short arc
Designed for severe abrasion applications

WELDING POSITIONS (ISO/ASME)



PA/1G



PB/2F

CURRENT TYPE

AC / DC +/-

CHEMICAL COMPOSITION (W%), TYPICAL, ALL WELD METAL

C	Cr	Si
5.0	35	4

STRUCTURE

In the as welded condition the microstructure consists of primary chromium carbides in an austenite - carbide eutectic matrix.

MECHANICAL PROPERTIES, TYPICAL, ALL WELD METAL

Typical hardness values

1 Layer 57-60 HRc
2 Layers 60-62 HRc
Welded on Mild Steel Plate

PACKAGING AND AVAILABLE SIZES

		Diameter (mm)			
		3.2	3.2	4.0	4.0
	Length (mm)	350	450	350	450
PE-Tube	Pieces / unit	48	37	32	23
	Net weight/unit (kg)	2.5	2.5	2.5	2.5

Identification Imprint: WEARSHIELD 60 (E) Tip Color: violet

Wearshield® 60 (e) rev. C-EN25-01/02/16

All information in this data sheet is accurate to the best of our knowledge at the time of printing. Please refer to www.lincolnelectric.eu for any updated information.
Fumes: Safety Data Sheets (SDS) are available on our website.

Wearshield® 60 (e)

APPLICATION

Wearshield 60 produces a primary carbide deposit with a hardness range of 60-62 HRC. The primary carbide microstructure makes Wearshield 60 ideally suitable for applications of severe abrasion.

Typical applications include:

- Crusher rolls, plates and jaws
- Conveyor screws and sleeves
- Shovel lips
- Brick & coke machinery
- Cement mill parts

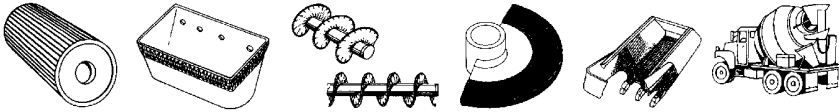

ADDITIONAL INFORMATION

When welding with Wearshield 60 stringer beads should be employed. Weaving is not advised since wide weaves generally increase the check crack spacing which can result in deposit spalling.

The as-welded deposit readily check cracks.

Preheat is not necessary when surfacing austenitic substrates such as stainless steels and manganese steels, although the interpass temperature should be limited to about 260°C for manganese steels.

The deposited weld metal is not machinable.

The deposit thickness is usually limited to 2 layers.

For applications requiring build-ups in excess of 2 layers, buttering layers of Arosta 307-160, Wearshield BU-30 or Wearshield Mangjet (manganese steels) should be used prior to Wearshield 60. Alternatively, a preheat of 650°C can be used to eliminate the formation of check cracks.

CALCULATION DATA

Diam. x length [mm]	Current range [A]	Current type	Dep. rate
			H(kg/h)
3.2 x 450	110-150	DC+	1.75
4.0 x 450	140-180	DC+	2.2

COMPLEMENTARY PRODUCTS

Lincore® 60-O and Lincore® 60-S with flux 801 or 802

Wearshield® 70

CLASSIFICATION

DIN 8555 E10-UM-65-GRZ
EN 14700 E Fe16

GENERAL DESCRIPTION

A highly alloyed basic-graphite coated downhand hardfacing electrode that produces a "premium" carbide weld deposit. Designed for high stress, severe abrasion and and abrasion at elevated temperatures
Recovery 240%.

WELDING POSITIONS (ISO/ASME)



PA/1G



PB/2F

CURRENT TYPE

AC / DC +

CHEMICAL COMPOSITION (W%), TYPICAL, ALL WELD METAL

C	Si	Cr	Mo	Nb	W
4.2	2.7	18	8.5	9.0	7.0

STRUCTURE

The microstructure consists mainly of primary chromium carbides with premium carbides of molybdenum, niobium, tungsten and vanadium in an austenite - carbide eutectic matrix.

MECHANICAL PROPERTIES, TYPICAL, ALL WELD METAL

Typical hardness values

1 Layer 62-67 typical 65 HRc
Welded on Mild Steel Plate

PACKAGING AND AVAILABLE SIZES

	Diameter (mm)	3.2	4.0	5.0
	Length (mm)	350	350	350
PE-Tube	Pieces / unit	28	18	12
	Net weight/unit (kg)	2.5	2.5	2.5

Identification Imprint: WEARSHIELD 70 Tip Color: violet

Wearshield® 70 rev. C-EN24-01/02/16

All information in this data sheet is accurate to the best of our knowledge at the time of printing. Please refer to www.lincolnelectric.eu for any updated information.
Fumes: Safety Data Sheets (SDS) are available on our website.

Wearshield® 70

APPLICATION

Wearshield 70 produces a "premium" carbide weld deposit with a hardness range of 62-70HRc. The premium carbide microstructure makes Wearshield 70 ideally suitable for applications of high stress abrasion (crushing of abrasive particles), severe abrasion and abrasion at elevated temperatures (>760°C)

Typical applications include:

- Blast furnace bells (burden area)
- Hoppers and screens
- Sinter plants
- Cement mill parts



ADDITIONAL INFORMATION

When welding with Wearshield 70 stringer beads are preferred, although weld widths up to 50mm by weaving are acceptable. A short welding arc is preferred and the drag technique is not recommended.

In the as welded condition readily check cracks and the spacings between the cracks are small even at slow travel speeds

Preheat is not necessary when surfacing austenitic substrates such as stainless steels and manganese steels, although the interpass temperature should be limited to about 260°C for manganese steels.

The deposited weld metal is not machinable or forgeable.

The deposit thickness is usually limited to 2 layers.

Optimum spalling resistance is achieved using austenitic substrates. For service conditions below 260°C an austenitic manganese substrate is preferred.

For high temperature applications >260°C, an austenitic stainless steel substrate should be used. (i.e. Arosta 307-160) Wearshield 70 will perform standard primary carbide electrodes (such as Wearshield 60) under either low stress or high temperature abrasion conditions.

CALCULATION DATA

Sizes		Current range (A)	Current type	Arc time - per electrode at max. current - (S)*	Energy E(kJ)	Dep. rate H(kg/h)	Weight/ 1000 pcs (kg)	Electrodes/ kg weldmetal B	kg electrodes/ kg weldmetal 1/N
Diam. x length (mm)									
3.2 x 350	120 - 160	AC	156	699	1.28	67	18	1.21	
4.0 x 350	180 - 220	AC	172	1011	1.50	100	14	1.40	
5.0 x 350	230 - 300	AC	194	1630	2.06	155	9	1.39	

COMPLEMENTARY PRODUCTS

There is no flux cored equivalent to Wearshield 70. The closest product is Lincore® 65-0, however, the deposit varies significantly to Wearshield 70.

Wearshield® 420

CLASSIFICATION

DIN 8555 E6-UM-55-RZ*
EN 14700 E Fe8

GENERAL DESCRIPTION

Heavily coated electrode that produces a martensitic deposit similar to AISI 420 stainless steel
Designed for abrasion resistance under high corrosion conditions
The electrode coating permits the use of the drag or contact welding technique as well as positional welding if required.

WELDING POSITIONS (ISO/ASME)



PA/1G



PC/2G



PF/3Gu



PE/4G

CURRENT TYPE

AC / DC +

CHEMICAL COMPOSITION (W%), TYPICAL, ALL WELD METAL

C	Si	Mn	Cr	Mo	V
0.5	0.4	0.3	12.4	0.4	1.3

STRUCTURE

Ferrite and martensite

MECHANICAL PROPERTIES, TYPICAL, ALL WELD METAL

Typical hardness values

55 HRC (560HB)

PACKAGING AND AVAILABLE SIZES

	Diameter (mm)	3.2	4.0	5.0
	Length (mm)	350	350	450
PE-Tube	Pieces / unit	51	36	22
	Net weight/unit (kg)	2.5	2.5	2.5

Identification Imprint: WEARSHIELD 420 Tip Color: brown

Wearshield® 420 rev. C-EN24-01/02/16

All information in this data sheet is accurate to the best of our knowledge at the time of printing. Please refer to www.lincolnelectric.eu for any updated information.
Fumes: Safety Data Sheets (SDS) are available on our website.

Wearshield® 420

APPLICATION

Wearshield 420 electrodes are intended to provide abrasion resistance under conditions of high corrosion, abrasion and impact.

The electrode can be used on carbon steels, low alloy steel and martensitic steel.

Typical applications include:

Sand pumps

Dredging equipment

Fans

Valve seats in steam and liquid pipes

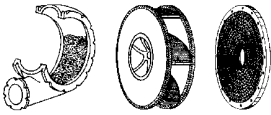

ADDITIONAL INFORMATION

All work-hardened base material and previously deposited hardfacing material should be removed prior to applying a new deposit, since such areas are prone to embrittlement and possible cracking. Areas that contain irregularities such as cracks and deep gouges can be repaired locally using Wearshield BU-30 or Wearshield 15CrMn prior to hardfacing with Wearshield 420. Preheat would be needed if the welding is done over either highly restrained material or martensitic stainless base metal.

A preheat and interpass temperature in the range of 200-300°C can be used depending on the nature of the material to be welded.

Under conditions of low dilution, the microstructure is similar to that of AISI 420 martensitic stainless steel. This structure provides good abrasion resistance under conditions of severe corrosion and high impact. At higher dilutions, when overlaid on mild steel or low alloy steel, the weld metal microstructure will retain its martensitic stainless structure. But the reduced chromium level might adversely affect the corrosion resistance of the deposit.

WELDING PARAMETERS, OPTIMUM FILL PASSES

Diameter (mm)	Welding positions			
	PA/1G	PC/2F	PF/3Gup	PE/4G
3.2	130A	130A	130A	130A
4.0	160A	160A	160A	150A
5.0	220A		200A	

CALCULATION DATA

Sizes		Current range (A)	Current type	Arc time - per electrode at max. current - (S)*	Energy E(kJ)	Dep. rate H(kg/h)	Weight/ 1000 pcs (kg)	Electrodes/ kg weldmetal B	kg electrodes/ kg weldmetal 1/N
Diam. x length (mm)	Current range (A)								
3.2 x 350	90 - 130	DC+	88	217	1.2	45.6	33	1.51	
4.0 x 350	120 - 170	DC+	114	544	1.4	70.2	23	1.59	
5.0 x 450	170 - 270	DC+	193	1187	1.4	109.8	14	1.49	

COMPLEMENTARY PRODUCTS

Lincore® 420.

RepTec Cast 1

CLASSIFICATION

AWS A5.15 ENi-CI
ISO 1071 E C Ni-CI

GENERAL DESCRIPTION

Ni-electrode for repair welding of lamellar cast iron, malleable cast iron and cast iron to steel

Produces a soft malleable weld deposit

Hardness weld deposit ~ 175 HB

Preferable welding on DC-, gives pulsed arc welding, deep penetration, smooth surface, no lack of fusion

Welding on AC, lowest heat input, important at filling

Best choice for multilayer welding

WELDING POSITIONS (ISO/ASME)



PA/1G



PB/2F



PC/2G



PF/3Gu



PG/3Gd



PE/4G



PH/5Gu



PJ/5Gd

CURRENT TYPE

AC / DC + / -

CHEMICAL COMPOSITION (W%), TYPICAL, ALL WELD METAL

C	Fe	Ni
0.7	2.0	97

MECHANICAL PROPERTIES, TYPICAL, ALL WELD METAL

Condition	0.2% Proof strength (N/mm ²)	Tensile strength (N/mm ²)	Elongation (%)	Hardness HB10
Required: AWS A5.15	262-414	276-448	3-6	135-218
ISO 1071	200	250	3	
Typical values AW	270	445	8	175

PACKAGING AND AVAILABLE SIZES

	Diameter (mm)	2.5	3.2	4.0
	Length (mm)	300	350	400
PE-Tube	Pieces / unit	146	76	44
	Net weight/unit (kg)	2.5	2.5	2.5
Linc Pack	Pieces / unit	58	30	-
	Net weight/unit (kg)	1.0	1.0	-

Identification Imprint: REPTec CAST 1 Tip Color: black

RepTec Cast 1: rev. C-EN24-01/02/16

RepTec Cast 1

EXAMPLES OF MATERIALS TO BE WELDED

Steel grades	DIN1691	DIN 1692	DIN 1693
For welding and repair			
	GG-10	GTS-35-10	GGG-40
	GG-15	GTS-45-06	GGG-50
	GG-20	GTS-55-4	GGG-60
	GG-25	GTW-35-04	
	GG-30	GTW-40-05	
	GG-35	GTW-45-07	
		GTW-S-38-12	

SMAW

CALCULATION DATA

Sizes		Current type	Arc time - per electrode at max. current - [S]*	Energy E[kJ]	Dep. rate H[kg/h]	Weight/ 1000 pcs [kg]	Electrodes/ kg weldmetal B	kg electrodes/ kg weldmetal 1/N
Diam. x length (mm)	Current range [A]							
2.5 x 300	50-100	DC-	176	268	0.24	19.1	84	1.61
3.2 x 350	70-130	DC-	145	303	0.48	32.6	52	1.52
4.0 x 400	90-150	DC-	262	647	0.55	56.7	25	1.41

*Stub end 35mm

WELDING PARAMETERS, OPTIMUM FILL PASSES

Diameter (mm)	Welding positions				
	PA/1G	PB/2F	PC/2G	PF/3Gup	PE/4G
2.5	70A	70A	70A	70A	70A
3.2	100A	100A	100A	100A	100A
4.0	120A	120A	120A	110A	110A

REMARKS / APPLICATION ADVICE

Residual stresses are decreased by peening after each layer
 Cold welding, interpass temperature ($T_i < 100^\circ\text{C}$)
 Heavy parts preheat (to max. 300°C)

COMPLEMENTARY PRODUCTS

LNM NiTi
 LNT NiTi

RepTec Cast 3

CLASSIFICATION

AWS A5.15 ENiFe-CI
ISO 1071 E C NiFe-CI 1

GENERAL DESCRIPTION

Basic graphite coated stick electrode with nickel iron core for cold welding of cast iron, malleable cast iron and joint welding to steel

Specially developed for good peen- and machinable seams e.g. for thick joints

In order to introduce as little heat into the work piece as possible, it is advisable to weld with DC positive

WELDING POSITIONS (ISO/ASME)



PA/1G



PB/2F



PC/2G



PF/3Gu



PG/3Gd



PE/4G

CURRENT TYPE

AC / DC +

CHEMICAL COMPOSITION (W%), TYPICAL, ALL WELD METAL

C	Fe	Ni
0.6	40	bal.

MECHANICAL PROPERTIES, TYPICAL, ALL WELD METAL

Condition		0.2% Proof strength [N/mm ²]	Tensile strength [N/mm ²]	Elongation [%]	Hardness HB10
Required: AWS A5.5		296-434	400-579	6-18	165-218
ISO 1071		250	350	6	
Typical values	AW	300	460	10	175

PACKAGING AND AVAILABLE SIZES

	Diameter (mm)	2.5	3.2	4.0
	Length (mm)	300	300	350
PE-Tube	Pieces / unit	155	95	54
	Net weight/unit (kg)	2.5	2.5	2.5

Identification Imprint: REPTec CAST 3 Tip Color: black

RepTec Cast 3: rev. C-EN23-01/02/16

RepTec Cast 3

EXAMPLES OF MATERIALS TO BE WELDED

Steel grades	DIN1691	DIN 1692	DIN 1693
For welding and repair			
	GG-10	GTS-35	GGG-40
	GG-15	GTS-45	GGG-50
	GG-20	GTS-55	GGG-60
	GG-25	GTW-35	GGG-70
	GG-30	GTW-40	GGG-80
	GG-35	GTW-45	
	GG-40	GTW-S-38	

SMAW

CALCULATION DATA

Sizes Diam. x length (mm)	Current range (A)	Current type	Arc time - per electrode at max. current - (S)*	Energy E(kJ)	Dep. rate H(kg/h)	Weight/ 1000 pcs (kg)	Electrodes/ kg weldmetal B	kg electrodes/ kg weldmetal 1/N
2.5 x 300	50-70	AC	58	106	0.76	15.9	82	1.3
3.2 x 300	70-90	AC	69	161	1.24	30.8	42	1.3
4.0 x 350	100-120	AC	75	234	1.78	46.2	27	1.2

*Stub end 35mm

WELDING PARAMETERS, OPTIMUM FILL PASSES

Diameter (mm)	Welding positions				
	PA/1G	PB/2F	PC/2G	PF/3Gup	PE/4G
2.5	60A	60A	60A	60A	70A
3.2	80A	80A	80A	75A	80A
4.0	110A	110A	110A	105A	110A

REMARKS / APPLICATION ADVICE

Welding of short beads is recommendable.
Peening (with a ball hammer) immediately after welding eliminates shrinkage stresses.
Perlitic cast iron often needs 200°C preheating.

COMPLEMENTARY PRODUCTS

LNM NiFe

RepTec Cast 31

CLASSIFICATION

AWS A5.15 ENiFe-CI
ISO 1071 E C NiFe-CI 1

GENERAL DESCRIPTION

Electrode for repair welding of cast iron, malleable cast iron and cast iron to steel

The nickel-iron weld deposit is easily machineable

Particularly applicable for nodular cast iron

Hardness weld deposit ~ 180 HB

Excellent current carrying capacity due to bi-metal core wire

Welding on AC and DC - polarity

Best choice welding DC -

WELDING POSITIONS (ISO/ASME)



PA/1G



PB/2F



PC/2G



PF/3Gu



PG/3Gd



PE/4G



PH/5Gu



PJ/5Gd

CURRENT TYPE

AC / DC -

CHEMICAL COMPOSITION (W%), TYPICAL, ALL WELD METAL

C	Fe	Ni
0.7	45	bal.

MECHANICAL PROPERTIES, TYPICAL, ALL WELD METAL

Condition	0.2% Proof strength (N/mm ²)	Tensile strength (N/mm ²)	Elongation (%)	Hardness HB10
Required: AWS A5.5	296-434	400-579	6-18	165-218
ISO 1071	250	350	6	
Typical values AW	300	460	10	180

PACKAGING AND AVAILABLE SIZES

	Diameter (mm)	2.5	3.2	4.0
	Length (mm)	300	350	400
PE-Tube	Pieces / unit	154	82	47
	Net weight/unit (kg)	2.5	2.5	2.5
Linc Pack	Pieces / unit	62	33	-
	Net weight/unit (kg)	1.0	1.0	-

Identification Imprint: REPTec CAST 31 Tip Color: black

RepTec Cast 31: rev. C-EN24-01/02/16

RepTec Cast 31

EXAMPLES OF MATERIALS TO BE WELDED

Steel grades	DIN1691	DIN 1692	DIN 1693
For welding and repair			
	GG-10	GTS-35-10	GGG-40
	GG-15	GTS-45-06	GGG-50
	GG-20	GTS-55-4	GGG-60
	GG-25	GTW-35-04	
	GG-30	GTW-40-05	
	GG-35	GTW-45-07	
		GTW-S-38-12	

CALCULATION DATA

Sizes Diam. x length (mm)	Current range (A)	Current type	Arc time - per electrode at max. current - (S)*	Energy E(kJ)	Dep. rate H(kg/h)	Weight/ 1000 pcs (kg)	Electrodes/ kg weldmetal B	kg electrodes/ kg weldmetal 1/N
2.5 x 300	70-100	DC-	124	211	0.32	19.1	91	1.72
3.2 x 350	90-150	DC-	123	328	0.62	29.4	47	1.37
4.0 x 400	100-180	DC	168	714	0.74	55.7	30	1.45

*Stub end 35mm

WELDING PARAMETERS, OPTIMUM FILL PASSES

Diameter (mm)	Welding positions				
	PA/1G	PB/2F	PC/2G	PF/3Gup	PE/4G
2.5	80A	80A	80A	80A	80A
3.2	110A	110A	110A	110A	110A
4.0	150A	160A	160A	150A	150A

REMARKS / APPLICATION ADVICE

Residual stresses are decreased by peening after each layer
Cold welding, interpass temperature (Ti<100°C)
Heavy parts preheat (to max. 300°C)

COMPLEMENTARY PRODUCTS

LNM NiFe

MIG/MAG WIRES

Typical Operations Procedures297

Mild Steel

LNM 25	298
UltraMag®	299
UltraMag® G45f1	300
SupraMIG®	301
SupraMIG® CF.....	302
SupraMig® HD	303
SupraMIG Ultra®	304
SupraMIG Ultra® CF	305
SupraMig Ultra® HD	306

Low Alloy Steel

LNM 28	307
LNM MoNi	308
LNM MoNiVa	309
LNM MoNiCr	310
LNM Ni1	311
LNM Ni2.5	312
LNM 12	313
LNM 19	314
LNM 20	315

Stainless Steel

LNM 304LSi	316
LNM 304L	317
LNM 347Si	318
LNM 316LSi	319
LNM 318Si	320
LNM 4439Mn	321
LNM 4455	322
LNM 4362	323
LNM 4462	324
LNM 4500	325
LNM 2507	326
LNM 309LSi.....	327
LNM 307	328
LNM 304H	329
LNM 309H	330
LNM 310	331
LNM 312	332

Nickel alloys

LNM NiCro 31/27	333
LNM NiCro 60/20	334
LNM NiCro 70/19	335
LNM NiTi	336
LNM NiFe	337

Copper alloys

LNM CuAl8	338
LNM CuAl8Ni6	339
LNM CuNi30	340
LNM CuSn	341
LNM CuSi3.....	342

Aluminium alloys

SuperGlaze® MIG 1070	343
SuperGlaze® MIG 1100	344
SuperGlaze® MIG 2319	345
SuperGlaze® MIG 4043.....	346
SuperGlaze® MIG 4047.....	347
SuperGlaze® MIG 5087	348
SuperGlaze® MIG 5183	349
SuperGlaze® MIG 5356	350
SuperGlaze® MIG 5356 TM.....	351
SuperGlaze® MIG 5556	352
SuperGlaze® MIG 5556A	353
SuperGlaze® MIG 5754	354

Hardfacing

LNM 420FM	355
LNM 4M	356



CONSISTENCY MATTERS

CHOOSE THE RIGHT WELDING WIRE
FOR YOUR APPLICATION



SupraMIG
WIRE

MIG/MAG WIRES

LNM 25
SupraMig®
SupraMig® CF

SupraMig® HD
SupraMig Ultra®
SupraMig Ultra® HD
UltraMag®
UltraMag® SG3

Diameter, polarity, Shielding gas	CTWD ⁽¹⁾ (mm)	Wire Feed Speed (m/min)	Voltage (V)	Approx. Current (A)	Melt-off rate (kg/hr)
0.6 mm, DC+					
Short Circuit Transfer 100% CO ₂	9-12	2.5	17	35	0.4
		6.4	19	80	0.9
0.8 mm, DC+					
Short Circuit Transfer 100% CO ₂	9-12	1.9	17	35	0.4
		3.8	18	70	0.8
		7.6	22	130	1.6
1.0 mm, DC+					
Short Circuit Transfer 100% CO ₂	9-12	2.5	18	80	0.7
		3.8	19	120	1.1
		6.4	22	175	1.8
Spray Transfer 90% Ar/10% CO ₂	12-19	9.5	23	195	2.7
		12.7	29	230	3.6
		15.2	30	275	4.4
1.2 mm, DC+					
Short Circuit Transfer 100% CO ₂ ⁽²⁾	12-19	3.2	19	145	1.5
		3.8	20	165	1.8
		5.1	21	200	2.5
Spray Transfer 80% Ar/20% CO ₂	12-19	8.9	27	285	4.2
		12.1	30	335	5.7
		12.7	30	340	6.0
1.4 mm, DC+					
Spray Transfer 80% Ar/20% CO ₂	12-19	7.6	30	300	4.8
		8.1	30	320	5.2
		12.3	32	430	7.8
1.6 mm, DC+					
Spray Transfer 80% Ar/20% CO ₂	12-25	5.3	25	325	4.8
		6.0	27	350	5.4
		7.4	28	430	6.7

⁽¹⁾ CTWD (Contact Tip to Work Distance). Subtract 6.4 mm to calculate Electrical Stickout.

⁽²⁾ Procedures in these areas are procedures for short circuiting mode using 100% CO₂. When using 80% Argon, 20% CO₂ for short circuit transfer, reduce voltage by 1 to 2 volts

LNM 25

CLASSIFICATION

AWS A5.18	ER70S-3	A-Nr	1	Mat-Nr	1.5112
EN ISO 14341-A	G 42 4 M 2Si	F-Nr	6		
		9606 FM	1		

GENERAL DESCRIPTION

Solid wire for welding general construction in mild steel
 High impact values
 Stable arc and excellent feedability

WELDING POSITIONS (ISO/ASME)



PA/1G



PB/2F



PC/2G



PD/4F



PE/4G



PF/3Gu

SHIELDING GASES (ACC. ISO 14175)

M21	Mixed gas Ar+ >15-25% CO ₂
C1	Active gas 100% CO ₂

APPROVALS

ABS	BV	DNV	GL	LR	TÜV	CE
+	+	+	+	+	+	+

CHEMICAL COMPOSITION (W%) TYPICAL WIRE

C	Mn	Si
0.08	1.1	0.6

MECHANICAL PROPERTIES, TYPICAL, ALL WELD METAL

	Shielding gas	Condition	Yield strength (N/mm ²)	Tensile strength (N/mm ²)	Elongation (%)	Impact ISO-V(J) -40°C
Typical values	M21	AW	490	544	28	149

EXAMPLES OF MATERIALS TO BE WELDED

Steel grades	Standard	Type
General structural steels	EN 10025	S185, S235, S275, S355
Ship plates	ASTM A131	Grade A, B, D, AH32 to DH 36.
Cast steels	EN 10213-2	GP240R
Pipe material	EN 10208-1	L210, L240, L290, L360
	EN 10208-2	L240NB, L290NB, L360NB, L360QB, L240MB, L290MB, L360MB, L415MB, L415NB
	API 5LX	X42, X46, X52, X60
	EN 10216-1	P235T1, P235T2, P275T1
	EN 10217-1	P275T2, P355N
Boiler & pressure vessel steels	EN 10028-2	P235GH, P265GH, P295GH, P355GH
Fine grained steels	EN 10025 part 3	S275, S355, S420
	EN 10025 part 4	S275M, S275ML, S355M, S355ML, S420M, S420ML

PACKAGING AND AVAILABLE SIZES

Diameter (mm)	0.8	1.0	1.2
15 kg spool B300	X	X	X
250 kg Accutrak® Drum			X

Other sizes and packaging on request

LNM 25: rev. C-EN25-01/02/16

UltraMag®

CLASSIFICATION

AWS A5.18	ER70S-6	A-Nr	1	Mat-Nr	1.5125
EN ISO 14341-A	G 46 4 M 3Si1 / G 42 3 C 3Si1	F-Nr	6		
		9606 FM	1		

GENERAL DESCRIPTION

Solid wire for semi-automatic and automatic welding applications
 Good feedability, consistent welding performance
 Very good weldability, stable arc, and low spatter
 High productivity

WELDING POSITIONS (ISO/ASME)



PA/1G



PB/2F



PC/2G



PD/4F



PE/4G



PF/3Gu

SHIELDING GASES (ACC. ISO 14175)

M21	Mixed gas Ar+ >15-25% CO ₂
C1	Active gas 100% CO ₂

APPROVALS

ABS	BV	DNV	GL	LR	TÜV	CE
+	+	+	+	+	+	+

CHEMICAL COMPOSITION (W%) TYPICAL WIRE

C	Mn	Si
0.078	1.4	0.85

MECHANICAL PROPERTIES, TYPICAL, ALL WELD METAL

	Shielding gas	Condition	Yield strength (N/mm ²)	Tensile strength (N/mm ²)	Elongation (%)	Impact ISO-V(J)	
						-30°C	-40°C
Typical values	M21	AW	502	574	28		102
	C1	AW	486	570	29	71	

EXAMPLES OF MATERIALS TO BE WELDED

Steel grades	Standard	Type
General structural steels	EN 10025	S185, S235, S275, S355
Ship plates	ASTM A131	Grade A, B, D, AH32 to DH36
Cast steels	EN 10213-2	GP240R
Pipe material	EN 10208-1	L210, L240, L290, L360
	EN 10208-2	L240NB, L290NB, L360NB, L360QB, L240MB, L290MB, L360MB, L415MB, L415NB
	API 5LX	X42, X46, X52, X60
	EN 10216-1	P235T1, P235T2, P275T1
	EN 10217-1	P275T2, P355N
Boiler & pressure vessel steels	EN 10028-2	P235GH, P265GH, P295GH, P355GH
Fine grained steels	EN 10025 part 3	S275, S355, S420
	EN 10025 part 4	S275M, S275ML, S355M, S355ML, S420M, S420ML, S460

PACKAGING AND AVAILABLE SIZES

Diameter (mm)	0.8	1.0	1.2	1.6
5 kg plastic spool S200	X		X	
15 kg spool B300			X	X
15 kg spool B500		X	X	X
15 kg spool S300			X	X
250 kg Accutrak® Drum		X	X	
500 kg Accutrak® Drum		X	X	X
Other sizes and packaging on request				

UltraMag® .rev. C-EN26-01/02/16

All information in this data sheet is accurate to the best of our knowledge at the time of printing. Please refer to www.lincolnelectric.eu for any updated information.
 Fumes: Safety Data Sheets (SDS) are available on our website.

LINCOLN
ELECTRIC
 THE WELDING EXPERTS®

UltraMag® G4Si1

CLASSIFICATION

AWS A5.18	ER70S-6	A-Nr	1	Mat-Nr	1.5130
EN ISO 14341-A	G 46 5 M 4Si1 / G 46 3 C 4Si1	F-Nr	6		
		9606 FM	1		

GENERAL DESCRIPTION

Coppered solid wire for semi-automatic and automatic welding applications
 Good feedability, consistent welding performance
 Very good weldability, stable arc, and low spatter
 High productivity

WELDING POSITIONS (ISO/ASME)



PA/1G



PB/2F



PC/2G



PD/4F



PE/4G



PF/3Gu

SHIELDING GASES (ACC. ISO 14175)

M21	Mixed gas Ar+ >15-25% CO ₂
C1	Active gas 100% CO ₂

APPROVALS

ABS	BV	DNV	GL	LR	CE	TÜV
+	+	+	+	+	+	+

CHEMICAL COMPOSITION (W%) TYPICAL WIRE

C	Mn	Si
0.08	1.70	0.85

MECHANICAL PROPERTIES, TYPICAL, ALL WELD METAL

	Shielding gas	Condition	Yield strength (N/mm ²)	Tensile strength (N/mm ²)	Elongation (%)	Impact ISO-V(J)	
						-40°C	-50°C
Typical values	M21	AW	490	590	27		90
	C1	AW	460	560	25	70	

EXAMPLES OF MATERIALS TO BE WELDED

Steel grades	Standard	Type
General structural steels	EN 10025	S185, S235, S275, S355
Ship plates	ASTM A131	Grade A, B, D, AH32 to DH36
Cast steels	EN 10213-2	GP240R
Pipe material	EN 10208-1	L210, L240, L290, L360
	EN 10208-2	L240NB, L290NB, L360NB, L360QB, L240MB, L290MB, L360MB, L415MB, L415NB
	API 5LX	X42, X46, X52, X60
	EN 10216-1	P235T1, P235T2, P275T1
	EN 10217-1	P275T2, P355N
Boiler & pressure vessel steels	EN 10028-2	P235GH, P265GH, P295GH, P355GH
Fine grained steels	EN 10025 part 3	S275, S355, S420, S460
	EN 10025 part 4	S275M, S275ML, S355M, S355ML, S420M, S420ML, S460, P460, S460ML

PACKAGING AND AVAILABLE SIZES

Diameter (mm)	0.8	1.0	1.2	1.6
15 Kg spool B300	X	X	X	X
15 Kg spool B5300	X	X	X	X
15 kg spool S300	X	X	X	X
250 kg Accutrak® Drum	X	X	X	
500 kg Accutrak® Drum	X	X	X	X

Ultramag® G4Si1.rev. C-EN26-01/02/16

Other sizes and packaging on request

 All information in this data sheet is accurate to the best of our knowledge at the time of printing. Please refer to www.lincolnelectric.eu for any updated information.
 Fumes: Safety Data Sheets (SDS) are available on our website.

SupraMig®

CLASSIFICATION

AWS A5.18	ER70S-6	A-Nr	1	Mat-Nr	1.5125
EN ISO 14341-A	G 46 4 M 3Si1 / G 42 3 C 3Si1	F-Nr	6		
		9606 FM	1		

GENERAL DESCRIPTION

Solid wire for welding of structural steels
Excellent feedability and very consistent welding performance
No adjustments of welding parameters
Tight and stable arc with extremely low spatter

Better bead profile and appearance
Ultimate GMAW wire for robotics and hard automation
Also provided in Accutrak®

WELDING POSITIONS (ISO/ASME)



SHIELDING GASES (ACC. ISO 14175)

M21	Mixed gas Ar+ >15-25% CO ₂
C1	Active gas 100% CO ₂

APPROVALS

ABS	BV	DNV	GL	LR	TÜV	DB	CE
+	+	+	+	+	+	+	+

CHEMICAL COMPOSITION (W%) TYPICAL WIRE

C	Mn	Si
0.08	1.40	0.85

MECHANICAL PROPERTIES, TYPICAL, ALL WELD METAL

	Shielding gas	Condition	Yield strength (N/mm ²)	Tensile strength (N/mm ²)	Elongation (%)	Impact ISO-V(J)	
						-30°C	-40°C
Typical values	M21	AW	502	574	28		102
	C1	AW	486	570	29	71	

EXAMPLES OF MATERIALS TO BE WELDED

Steel grades	Standard	Type
General structural steels	EN 10025	S185, S235, S275, S355
Ship plates	ASTM A131	Grade A, B, D, AH32 to DH36
Cast steels	EN 10213-2	GP240R
Pipe material	EN 10208-1	L210, L240, L290, L360
	EN 10208-2	L240NB, L290NB, L360NB, L360QB, L240MB, L290MB, L360MB, L415MB, L415NB
	API 5LX	X42, X46, X52, X60
	EN 10216-1	P235T1, P235T2, P275T1
	EN 10217-1	P275T2, P355N
	Boiler & pressure vessel steels	EN 10028-2
Fine grained steels	EN 10025 part 3	S275, S355, S420
	EN 10025 part 4	S275M, S275ML, S355M, S355ML, S420M, S420ML, S460

PACKAGING AND AVAILABLE SIZES

Diameter (mm)	0.8	1.0	1.2	1.6
15 kg spool B300	X	X		X
15 kg spool S300	X	X	X	X
250 kg Accutrak® Drum	X	X	X	X
500 kg Accutrak® Drum		X	X	X

Other sizes and packaging on request

All information in this data sheet is accurate to the best of our knowledge at the time of printing. Please refer to www.lincolnelectric.eu for any updated information.
Fumes: Safety Data Sheets (SDS) are available on our website.

Supramig® .rev. C-EN26-01/02/16

LINCOLN
ELECTRIC
THE WELDING EXPERTS®

SupraMig® CF

CLASSIFICATION

AWS A5.18	ER70S-6	A-Nr	1	Mat-Nr	1.5125
EN ISO 14341-A	G 46 4 M 3Si1 / G 42 3 C 3Si1	F-Nr	6		
		9606 FM	1		

GENERAL DESCRIPTION

Uncoppered solid wire for welding of structural steels
Excellent feedability and very consistent welding performance
No adjustments of welding parameters
Tight and stable arc with extremely low spatter

Better bead profile and appearance
Ultimate GMAW wire for robotics and hard automation
Also provided in Accutrak®

WELDING POSITIONS (ISO/ASME)

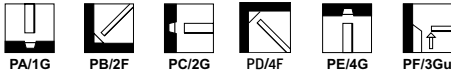

SHIELDING GASES (ACC. ISO 14175)

M21	Mixed gas Ar+ >15-25% CO ₂
C1	Active gas 100% CO ₂

APPROVALS

ABS	BV	DNV	GL	LR	TÜV	DB	CE
+	+	+	+	+	+	+	+

CHEMICAL COMPOSITION (W%) TYPICAL WIRE

C	Mn	Si
0.08	1.40	0.85

MECHANICAL PROPERTIES, TYPICAL, ALL WELD METAL

	Shielding gas	Condition	Yield strength (N/mm ²)	Tensile strength (N/mm ²)	Elongation (%)	Impact ISO-V(J)	
						-30°C	-40°C
Typical values	M21	AW	502	574	28		102
	C1	AW	486	570	29	71	

EXAMPLES OF MATERIALS TO BE WELDED

Steel grades	Standard	Type
General structural steels	EN 10025	S185, S235, S275, S355
Ship plates	ASTM A131	Grade A, B, D, AH32 to DH36
Cast steels	EN 10213-2	GP240R
Pipe material	EN 10208-1	L210, L240, L290, L360
	EN 10208-2	L240NB, L290NB, L360NB, L360QB, L240MB, L290MB, L360MB, L415MB, L415NB
	API 5LX	X42, X46, X52, X60
	EN 10216-1	P235T1, P235T2, P275T1
	EN 10217-1	P275T2, P355N
Boiler & pressure vessel steels	EN 10028-2	P235GH, P265GH, P295GH, P355GH
Fine grained steels	EN 10025 part 3	S275, S355, S420
	EN 10025 part 4	S275M, S275ML, S355M, S355ML, S420M, S420ML, S460

PACKAGING AND AVAILABLE SIZES

Diameter (mm)	0.8	1.0	1.2	1.6
15 Kg spool B300	X	X	X	X
15 Kg spool B5300		X	X	
15 kg spool S300	X	X	X	
250 kg Accutrak® Drum	X	X	X	X
500 kg Accutrak® Drum		X	X	X

Supramig® CF : rev. C-EN01-01/02/16

SupraMig® HD

CLASSIFICATION

AWS A5.18	ER70S-6	A-Nr	1	Mat-Nr	1.5125
EN ISO 14341-A	G 46 4 M 3Si1 / G 42 3 C 3Si1	F-Nr	6		
		9606 FM	1		

GENERAL DESCRIPTION

Solid wire for welding of structural steels
Excellent feedability and very consistent welding performance
Self releasing silicate islands

Tight and stable arc with extremely low spatter
Deep root penetration and improved fatigue life
Ultimate GMAW wire for heavy duty high deposition applications

WELDING POSITIONS (ISO/ASME)



PA/1G



PB/2F



PC/2G



PD/4F



PE/4G



PF/3Gu

SHIELDING GASES (ACC. ISO 14175)

M21	Mixed gas Ar+ >15-25% CO ₂
C1	Active gas 100% CO ₂

APPROVALS

ABS	BV	DNV	GL	LR	TÜV	CE	DB
+	+	+	+	+	+	+	+

CHEMICAL COMPOSITION (W%) TYPICAL WIRE

C	Mn	Si
0.08	1.40	0.85

MECHANICAL PROPERTIES, TYPICAL, ALL WELD METAL

	Shielding gas	Condition	Yield strength (N/mm ²)	Tensile strength (N/mm ²)	Elongation (%)	Impact ISO-V(J)	
						-30°C	-40°C
Typical values	M21	AW	502	574	28		102
	C1	AW	486	570	29	71	

EXAMPLES OF MATERIALS TO BE WELDED

Steel grades	Standard	Type
General structural steels	EN 10025	S185, S235, S275, S355
Ship plates	ASTM A131	Grade A, B, D, AH32 to DH36
Cast steels	EN 10213-2	GP240R
Pipe material	EN 10208-1	L210, L240, L290, L360
	EN 10208-2	L240NB, L290NB, L360NB, L360QB, L240MB, L290MB, L360MB, L415MB, L415NB
	API 5LX	X42, X46, X52, X60
	EN 10216-1	P235T1, P235T2, P275T1
	EN 10217-1	P275T2, P355N
Boiler & pressure vessel steels	EN 10028-2	P235GH, P265GH, P295GH, P355GH
Fine grained steels	EN 10025 part 3	S275, S355, S420
	EN 10025 part 4	S275M, S275ML, S355M, S355ML, S420M, S420ML, S460

PACKAGING AND AVAILABLE SIZES

Diameter (mm)	0.8	1.0	1.2	1.6
15 Kg spool B300	X	X	X	X
15 Kg spool B5300	X	X	X	X
15 kg spool S300	X	X	X	X
250 kg Accutrak® Drum	X	X	X	
500 kg Accutrak® Drum	X	X	X	X
Other sizes and packaging on request				

Supramig® HD :rev. C-EN04-01/02/16

SupraMig Ultra®

CLASSIFICATION

AWS A5.18	ER70S-6	A-Nr	1	Mat-Nr	1.5130
EN ISO 14341-A	G 50 5 M 4Si1 / G 46 3 C 4Si1	F-Nr	6		
		9606 FM	1		

GENERAL DESCRIPTION

Solid wire with increased manganese for semi-automatic welding and robotic applications
 Excellent feedability and very consistent welding performance
 Tight and stable arc with extremely low spatter
 Also provided in Accutrak® drum

WELDING POSITIONS (ISO/ASME)



PA/1G



PB/2F



PC/2G



PD/4F



PE/4G



PF/3Gu

SHIELDING GASES (ACC. ISO 14175)

M21	Mixed gas Ar+ >15-25% CO ₂
C1	Active gas 100% CO ₂

APPROVALS

ABS	BV	DNV	GL	LR	TÜV	CE
+	+	+	+	+	+	+

CHEMICAL COMPOSITION (W%) TYPICAL WIRE

C	Mn	Si
0.08	1.70	0.85

MECHANICAL PROPERTIES, TYPICAL, ALL WELD METAL

	Shielding gas	Condition	Yield strength (N/mm ²)	Tensile strength (N/mm ²)	Elongation (%)	Impact ISO-V(J)		
						-20°C	-40°C	-50°C
Typical values	M21	AW	500	650	26	80	80	70
	C1	AW	490	620	30	60	50	

EXAMPLES OF MATERIALS TO BE WELDED

Steel grades	Standard	Type
General structural steels	EN 10025	S185, S235, S275, S355
Ship plates	ASTM A131	Grade A, B, D, AH32 to DH36
Cast steels	EN 10213-2	GP240R
Pipe material	EN 10208-1	L210, L240, L290, L360
	EN 10208-2	L240NB, L290NB, L360NB, L360QB, L240MB, L290MB, L360MB, L415MB, L415NB
	API 5LX	X42, X46, X52, X60
	EN 10216-1	P235T1, P235T2, P275T1
	EN 10217-1	P275T2, P355N
Boiler & pressure vessel steels	EN 10028-2	P235GH, P265GH, P295GH, P355GH
Fine grained steels	EN 10025 part 3	S275, S355, S420, S460
	EN 10025 part 4	S275M, S275ML, S355M, S355ML, S420M, S420ML, S460, P460, S460ML

PACKAGING AND AVAILABLE SIZES

Diameter (mm)	0.8	1.0
15 Kg spool B300	X	X
15 Kg spool B5300		X
15 kg spool S300		X
250 kg Accutrak® Drum	X	X
500 kg Accutrak® Drum		X

Supramig® Ultra: rev. C-EN26-01/02/16

All information in this data sheet is accurate to the best of our knowledge at the time of printing. Please refer to www.lincolnelectric.eu for any updated information.
 Fumes: Safety Data Sheets (SDS) are available on our website.

SupraMig Ultra® CF

CLASSIFICATION

AWS A5.18	ER70S-6	A-Nr	1	Mat-Nr	1.5130
EN ISO 14341-A	G 50 5 M 4Si1 / G 46 3 C 4Si1	F-Nr	6		
		9606 FM	1		

GENERAL DESCRIPTION

Uncoppered solid wire with increased manganese for semi-automatic welding and robotic applications
 Excellent feedability and very consistent welding performance
 Tight and stable arc with extremely low spatter
 Also provided in Accutrak® drum

WELDING POSITIONS (ISO/ASME)



PA/1G



PB/2F



PC/2G



PD/4F



PE/4G



PF/3Gu

SHIELDING GASES (ACC. ISO 14175)

M21	Mixed gas Ar+ >15-25% CO ₂
C1	Active gas 100% CO ₂

APPROVALS

ABS	BV	DNV	GL	LR	TÜV	CE
+	+	+	+	+	+	+

CHEMICAL COMPOSITION (W%) TYPICAL WIRE

C	Mn	Si
0.08	1.70	0.85

MECHANICAL PROPERTIES, TYPICAL, ALL WELD METAL

	Shielding gas	Condition	Yield strength (N/mm ²)	Tensile strength (N/mm ²)	Elongation (%)	Impact ISO-V(J)	
						-20°C	-40°C
Typical values	M21	AW	500	650	26	80	80
	C1	AW	490	620	30	60	50

EXAMPLES OF MATERIALS TO BE WELDED

Steel grades	Standard	Type
General structural steels	EN 10025	S185, S235, S275, S355
Ship plates	ASTM A131	Grade A, B, D, AH32 to DH36
Cast steels	EN 10213-2	GP240R
Pipe material	EN 10208-1	L210, L240, L290, L360
	EN 10208-2	L240NB, L290NB, L360NB, L360QB, L240MB, L290MB, L360MB, L415MB, L415NB
	API 5LX	X42, X46, X52, X60
	EN 10216-1	P235T1, P235T2, P275T1
	EN 10217-1	P275T2, P355N
Boiler & pressure vessel steels	EN 10028-2	P235GH, P265GH, P295GH, P355GH
Fine grained steels	EN 10025 part 3	S275, S355, S420, S460
	EN 10025 part 4	S275M, S275ML, S355M, S355ML, S420M, S420ML, S460, P460, S460ML

PACKAGING AND AVAILABLE SIZES

Diameter (mm)	0.8	1.0
15 Kg spool B300	X	X
15 Kg spool B5300		X
15 kg spool S300		X
250 kg Accutrak® Drum	X	X
500 kg Accutrak® Drum		X
Other sizes and packaging on request		

Supramig® Ultra CF: rev. C-EN01-01/02/16

All information in this data sheet is accurate to the best of our knowledge at the time of printing. Please refer to www.lincolnelectric.eu for any updated information.
 Fumes: Safety Data Sheets (SDS) are available on our website.

SupraMig Ultra[®] HD

CLASSIFICATION

AWS A5.18	ER70S-6	A-Nr	1	Mat-Nr	1.5130
EN ISO 14341-A	G 50 5 M 4Si1 / G 46 3 C 4Si1	F-Nr	6		
		9606 FM	1		

GENERAL DESCRIPTION

Solid wire with increased manganese for semi-automatic welding and robotic applications
Excellent feedability and very consistent welding performance
Good weld bead aspect

Tight and stable arc with extremely low spatter
Ultimate GMAW wire for heavy duty high deposition applications

WELDING POSITIONS (ISO/ASME)



PA/1G



PB/2F



PC/2G



PD/4F



PE/4G



PF/3Gu

SHIELDING GASES (ACC. ISO 14175)

M21	Mixed gas Ar+ >15-25% CO ₂
C1	Active gas 100% CO ₂

APPROVALS

ABS	BV	DNV	GL	LR	CE	TÜV
+	+	+	+	+	+	+

CHEMICAL COMPOSITION (W%) TYPICAL WIRE

C	Mn	Si
0.08	1.70	0.85

MECHANICAL PROPERTIES, TYPICAL, ALL WELD METAL

	Shielding gas	Condition	Yield strength (N/mm ²)	Tensile strength (N/mm ²)	Elongation (%)	Impact ISO-V(J)	
						-20°C	-40°C
Typical values	M21	AW	500	650	26	80	80
	C1	AW	490	620	30	60	50

EXAMPLES OF MATERIALS TO BE WELDED

Steel grades	Standard	Type
General structural steels	EN 10025	S185, S235, S275, S355
Ship plates	ASTM A131	Grade A, B, D, AH32 to DH36
	EN 10213-2	GP240R
Pipe material	EN 10208-1	L210, L240, L290, L360
	EN 10208-2	L240NB, L290NB, L360NB, L360QB, L240MB, L290MB, L360MB, L415MB, L415NB
	API 5LX	X42, X46, X52, X60
	EN 10216-1	P235T1, P235T2, P275T1
	EN 10217-1	P275T2, P355N
Boiler & pressure vessel steels	EN 10028-2	P235GH, P265GH, P295GH, P355GH
Fine grained steels	EN 10025 part 3	S275, S355, S420, S460
	EN 10025 part 4	S275M, S275ML, S355M, S355ML, S420M, S420ML, S460, P460, S460ML

PACKAGING AND AVAILABLE SIZES

Diameter (mm)	1.2	1.4	1.6
15 Kg spool B300	X		X
15 Kg spool B5300	X		
15 Kg spool S300	X	X	X
250 kg Accutrak [®] Drum	X	X	X
500 kg Accutrak [®] Drum	X	X	X

Other sizes and packaging on request

Supramig[®] Ultra HD: rev. C-EN02-01/02/16

All information in this data sheet is accurate to the best of our knowledge at the time of printing. Please refer to www.lincolnelectric.eu for any updated information.
Fumes: Safety Data Sheets (SDS) are available on our website.

LNM 28

CLASSIFICATION

AWS A5.28	ER80S-G	A-Nr	10
EN ISO 16834-A	G Z Mn3 Ni1 Cu*	F-Nr	6
* Nearest classification		9606 FM	2

GENERAL DESCRIPTION

Solid wire special for welding of weather resisting steels
Contains a small percentage of copper to help preventing further oxidation of the weld bead

WELDING POSITIONS (ISO/ASME)



PA/1G



PB/2F



PC/2G



PD/4F



PE/4G



PF/3Gu

SHIELDING GASES (ACC. ISO 14175)

M21	Mixed gas Ar+ >15-25% CO ₂
C1	Active gas 100% CO ₂

CHEMICAL COMPOSITION (W%) TYPICAL WIRE

C	Mn	Si	Ni	Cu
0.1	1.4	0.75	0.8	0.3

MECHANICAL PROPERTIES, TYPICAL, ALL WELD METAL

Typical values	Shielding gas		Yield strength (N/mm ²)	Tensile strength (N/mm ²)	Elongation (%)	Impact ISO-V(J)	
	M21	AW				-20°C	-40°C
			570	620	26	90	70

EXAMPLES OF MATERIALS TO BE WELDED

Steel grades	Standard	Type
Weather resisting steels	EN 10155	S 235 J 0 W
		S 235 J 2 W
		S 355 J 0 W
		S 355 J 2 W
		S 355 J 2 G 1 W

PACKAGING AND AVAILABLE SIZES

Diameter (mm)	1.0	1.2
15 Kg spool B300	X	X

Other sizes and packaging on request

LNM 28: rev. C-EN23-01/02/16

LNM MoNi

CLASSIFICATION

AWS A5.28	ER1005-G	A-Nr	12
EN ISO 16834-A	G 62 4 M Mn3NiCrMo	F-Nr	6
		9606 FM	2

GENERAL DESCRIPTION

Solid wire for welding high strength steels with a yield up to 620 Mpa
Good impact values at -40 °C

WELDING POSITIONS (ISO/ASME)



PA/1G



PB/2F



PC/2G



PD/4F



PE/4G



PF/3Gu

SHIELDING GASES (ACC. ISO 14175)

M21 Mixed gas Ar+ >15-25% CO₂

GMAW

CHEMICAL COMPOSITION (W%) TYPICAL WIRE

C	Mn	Si	Ni	Cr	Mo	Cu
0.10	1.65	0.75	0.55	0.60	0.30	0.08

MECHANICAL PROPERTIES, TYPICAL, ALL WELD METAL

	Shielding gas	Condition	Yield strength (N/mm ²)	Tensile strength (N/mm ²)	Elongation (%)	Impact ISO-V(J)		
						-20°C	-40°C	-60°C
Typical values	M21	AW	635	770	19	100	90	70

EXAMPLES OF MATERIALS TO BE WELDED

Steel grades	Standard	Type
Pipe material	API-5LX	X65, X70, X80
	EN 10208-2	L480, L550
Fine grained steels	EN 10025 part 6	S460, S500, S550, S620 S690 S620GI1, S600MC, TstE620, Weldox 500, Hardox

PACKAGING AND AVAILABLE SIZES

Diameter (mm)	1.0	1.2
15 Kg spool B300	X	X

Other sizes and packaging on request

LNM MoNi rev. C-EN24-01/02/16

LNM MoNiVa

CLASSIFICATION

AWS A5.28	ER110S-G	A-Nr	12
EN ISO 16834-A	G 69 4 M Mn3NiCrM	F-Nr	6
		9606 FM	2

GENERAL DESCRIPTION

Solid wire for welding high strength steels with yield strength up to 690 N/mm²
Good impact values at -40°C

WELDING POSITIONS (ISO/ASME)



PA/1G



PB/2F



PC/2G



PD/4F



PE/4G



PF/3Gu

SHIELDING GASES (ACC. ISO 14175)

M21 Mixed gas Ar+ >15-25% CO₂

APPROVALS

ABS	DB	TÜV	CE
+	+	+	+

CHEMICAL COMPOSITION (W%) TYPICAL WIRE

C	Mn	Si	Ni	Cr	Mo	V	Cu
0.08	1.7	0.44	1.35	0.23	0.3	0.08	0.25

MECHANICAL PROPERTIES, TYPICAL, ALL WELD METAL

Typical values	Shielding gas	Condition	Yield strength	Tensile strength	Elongation	Impact ISO-V(J)
			(N/mm ²)	(N/mm ²)	(%)	-40°C
	M21	AW	710	790	20	70

EXAMPLES OF MATERIALS TO BE WELDED

Steel grades	Standard	Type
Pipe material	API-5LX	X65, X70, X80
	EN 10208-2	L480, L550
Fine grained steels	EN 10025 part 6	S460, S500, S550, S620 S690
		S620GI1, S600MC, TstE620, Weldox 500, Hardox

PACKAGING AND AVAILABLE SIZES

Diameter (mm)	0.8	1.0	1.2
15 Kg spool B300	X	X	X

Other sizes and packaging on request

LNM MoNiVa rev. C-ENZ7-21/04/16

All information in this data sheet is accurate to the best of our knowledge at the time of printing. Please refer to www.lincolnelectric.eu for any updated information.
Fumes: Safety Data Sheets (SDS) are available on our website.

LINCOLN
ELECTRIC
THE WELDING EXPERTS®

LNM MoNiCr

CLASSIFICATION

AWS A5.28	ER1205-G	A-Nr	12
EN ISO 16834-A	G 89 4 M Mn4Ni2CrMo	F-Nr	6
		9606 FM	2

GENERAL DESCRIPTION

Solid wire for welding high strength steels with yield strength up to 890MPa
 Can be used as well as for welding grade S960 (undermatching)
 Good impact toughness value down to -60°C

WELDING POSITIONS (ISO/ASME)

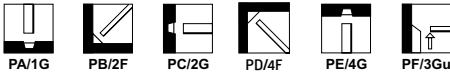

SHIELDING GASES (ACC. ISO 14175)

M21 Mixed gas Ar+ >15-25% CO₂

GMAW

CHEMICAL COMPOSITION (W%) TYPICAL WIRE

C	Mn	Si	Ni	Cr	Mo
0.09	1.8	0.80	2.20	0.30	0.55

MECHANICAL PROPERTIES, TYPICAL, ALL WELD METAL

Typical values	Shielding gas	Condition	Yield strength	Tensile strength	Elongation	Impact ISO-V(J)	
			(N/mm ²)	(N/mm ²)	(%)	-40°C	-60°C
	M21	AW	>890	950	>15	70	>50

EXAMPLES OF MATERIALS TO BE WELDED

Steel grades	Standard	Type
Fine grained steels	EN 10025 part 6 S960 (undermatching)	S890

PACKAGING AND AVAILABLE SIZES

Diameter (mm)	1.2
15 Kg spool B300	X
Other sizes and packaging on request	

LNM MoNiCr: rev. C-EN06-01/02/16

LNМ Ni1

CLASSIFICATION

AWS A5.28	ER80S-Ni1	A-Nr	10
EN ISO 14341-A	G 46 5 M 3Ni1	F-Nr	6
		9606 FM	2

GENERAL DESCRIPTION

Solid wire for welding fine grained and low alloy nickel steels

High impact value at low temperature [-60°C]

Typical offshore applications

Stable arc and excellent feedability

WELDING POSITIONS (ISO/ASME)



PA/1G



PB/2F



PC/2G



PD/4F



PE/4G



PF/3Gu

SHIELDING GASES (ACC. ISO 14175)

M21 Mixed gas Ar+ >15-25% CO₂

APPROVALS

DB	TÜV
+	+

CHEMICAL COMPOSITION (W%) TYPICAL WIRE

C	Mn	Si	Ni
0.09	1.2	0.6	0.9

MECHANICAL PROPERTIES, TYPICAL, ALL WELD METAL

Typical values	Shielding gas	Condition	Yield strength	Tensile strength	Elongation	Impact ISO-V(J)
			(N/mm ²)	(N/mm ²)	(%)	-60°C
	M21	AW	480	580	30	60

EXAMPLES OF MATERIALS TO BE WELDED

Steel grades	Standard	Type
General structural steels	EN 10025	S275, S355
Ship plates	ASTM A131	ASTM A131
Cast steels	EN 10213-2	GP240R
Pipe material	EN 10208-1	L290 GA, L360GA
	EN 10208-2	L290, L360, L415
	API 5LX	X42, X46, X52, X60, X65
	EN 10216-1	P275T1
	EN 10217-1	P275 T2, P355 N
Fine grained steels	EN 10025 part 3/4	S275, S355, S420, S460
	EN 10028	P355NL-1, P460NL-1

PACKAGING AND AVAILABLE SIZES

Diameter (mm)	1.0	1.2
---------------	-----	-----

5 kg plastic spool S200 X

15 Kg spool B300 X X

Other sizes and packaging on request

LNМ Ni1 rev. C-EN27-01/02/16

LNM Ni2.5

CLASSIFICATION

AWS A5.28	ER80S-Ni2	A-Nr	10
EN ISO 14341-A	G 46 6 M 2Ni2	F-Nr	6
		9606 FM	1/2

GENERAL DESCRIPTION

Solid wire for welding fine grained and low alloy nickel steels
 High impact value at low temperature [-60°C as welded and -90°C after stress relieving 15h/580°C].
 Typical offshore applications

WELDING POSITIONS (ISO/ASME)

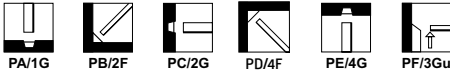

SHIELDING GASES (ACC. ISO 14175)

M21 Mixed gas Ar+ >15-25% CO₂

GMAW

APPROVALS

TÜV

+

CHEMICAL COMPOSITION (W%) TYPICAL WIRE

C	Mn	Si	Ni
0.1	1.1	0.55	2.4

MECHANICAL PROPERTIES, TYPICAL, ALL WELD METAL

	Shielding gas	Condition	Yield strength (N/mm ²)	Tensile strength (N/mm ²)	Elongation (%)	Impact ISO-V(J) -60°C
Typical values	M21	AW	490	580	24	85

EXAMPLES OF MATERIALS TO BE WELDED

Steel grades	Standard	Type
General structural steels	EN 10025	S355
Pipe material	API-5LX EN 10208-2	X52, X56, X60, X65 L360, L415, L445
Fine grained steels	EN 10025 part 3/4	S355, S420, S460
Low temperature steels	EN 10028-4 EN 10222-3	11 MnNi 5-3, 13 MnNi 6-3, 15 NiMn 6 [12 Ni 14 G 1, G 2] 13 MnNi 6-3, 15 NiMn 6

PACKAGING AND AVAILABLE SIZES

Diameter (mm)	1.0	1.2
15 Kg spool B300	X	X
Other sizes and packaging on request		

LNM Ni2.5; rev. C-EN25-01/02/16

LNM 12

CLASSIFICATION

AWS A5.28	ER70S-A1	A-Nr	2	Mat-Nr	1.5424
EN ISO 14341-A	G 46 3 M 2Mo	F-Nr	6		
		9606 FM	1/3		

GENERAL DESCRIPTION

Solid wire for welding creep resistant 0.5%Mo steels and Fine grained steels for low temperature applications in the as welded condition with service temperatures in range -30°C to +500°C

WELDING POSITIONS (ISO/ASME)



PA/1G



PB/2F



PC/2G



PD/4F



PE/4G



PF/3Gu

SHIELDING GASES (ACC. ISO 14175)

M21	Mixed gas Ar+ >15-25% CO ₂
C1	Active gas 100% CO ₂

APPROVALS

TÜV

+

CHEMICAL COMPOSITION (W%) TYPICAL WIRE

C	Mn	Si	Mo
0.1	1.12	0.6	0.5

MECHANICAL PROPERTIES, TYPICAL, ALL WELD METAL

	Shielding gas	Condition	Yield strength [N/mm ²]	Tensile strength [N/mm ²]	Elongation [%]	Impact ISO-V[J]	
						+20°C	-20°C
Typical values	M21	AW	503	606	24	130	74

EXAMPLES OF MATERIALS TO BE WELDED

Steel grades	Standard	Type
Elevated temperature steel	EN 10028-2	P295 G H, P355 G H, 16 Mo 2
EN 10222-2	17 Mo 3, 14 Mo 6	
Fine grained steels	EN 10025 part 3	S275, S355, S420, S460
EN 10025 part 4	S275, S355, S420, S460	

APPLICATION ADVICE

Preheating welding joint acc.EN 1011-1
Stress relieving 580-650°C if necessary

PACKAGING AND AVAILABLE SIZES

Diameter [mm]	0.8	1.0	1.2
15 Kg spool B300	X	X	X
Other sizes and packaging on request			

LNM 12 rev. C-EN26-01/02/16

All information in this data sheet is accurate to the best of our knowledge at the time of printing. Please refer to www.lincolnelectric.eu for any updated information.
Fumes: Safety Data Sheets (SDS) are available on our website.

LINCOLN
ELECTRIC
THE WELDING EXPERTS®

LNM 19

CLASSIFICATION

AWS A5.28	ER80S-B2*	A-Nr	3	Mat-Nr	1.7339
ISO 21952-A	G CrMo1Si	F-Nr	6		
* Nearest classification		9606 FM	3		

GENERAL DESCRIPTION

Solid wire for welding creep and hydrogen resistant Cr-Mo steels [1,25Cr - 0,5Mo]
Service temperature up to 550°C

WELDING POSITIONS (ISO/ASME)



PA/1G



PB/2F



PC/2G



PD/4F



PE/4G



PF/3Gu

SHIELDING GASES (ACC. ISO 14175)

M21	Mixed gas Ar+ >15-25% CO ₂
C1	Active gas 100% CO ₂ Mixed gas
M13	Mixed gas Ar+ >5-25% CO ₂

APPROVALS

TÜV

+

CHEMICAL COMPOSITION (W%) TYPICAL WIRE

C	Mn	Si	Cr	Mo
0.1	1.0	0.5	1.2	0.5

MECHANICAL PROPERTIES, TYPICAL, ALL WELD METAL

	Shielding gas	Condition	Yield strength (N/mm ²)	Tensile strength (N/mm ²)	Elongation (%)	Impact ISO-V(J) +20°C
Typical values	M21	PWHT 700°C/1h	530	635	23	160

EXAMPLES OF MATERIALS TO BE WELDED

Steel grades	Standard	Type
Elevated temperature steel	EN 10028-2	13 CrMo4-5
EN 10083-1	25 CrMo 4	
EN 10222-2	14 CrMo 4-5	
Tool steel	DIN 17210	16 MnCr 5

APPLICATION ADVICE

Preheating welding joint acc. EN 1011-1, 200-250°C
Post weld heat treatment at 660-700°C

PACKAGING AND AVAILABLE SIZES

Diameter (mm)	1.0	1.2
15 Kg spool B300	X	X

Other sizes and packaging on request

LNM 19 rev. C-EN26-01/02/16

All information in this data sheet is accurate to the best of our knowledge at the time of printing. Please refer to www.lincolnelectric.eu for any updated information. Fumes: Safety Data Sheets (SDS) are available on our website.

LNM 20

CLASSIFICATION

AWS A5.28	ER90S-B3*	A-Nr	4	Mat-Nr	1.7384
ISO 21952-A	G CrMo2Si	F-Nr	6		
* Nearest classification		9606 FM	3		

GENERAL DESCRIPTION

Solid wire for welding creep and hydrogen resistant Cr-Mo steels (2,25Cr - 1Mo)
Service temperature up to 600°C

WELDING POSITIONS (ISO/ASME)



PA/1G



PB/2F



PC/2G



PD/4F



PE/4G



PF/3Gu

SHIELDING GASES (ACC. ISO 14175)

M21	Mixed gas Ar+ >15-25% CO ₂
C1	Active gas 100% CO ₂
M13	Mixed gas Ar+ >0-3% CO ₂

CHEMICAL COMPOSITION (W%) TYPICAL WIRE

C	Mn	Si	Cr	Mo
0.08	0.9	0.6	2.5	1.0

MECHANICAL PROPERTIES, TYPICAL, ALL WELD METAL

	Shielding gas	Condition	Yield strength (N/mm ²)	Tensile strength (N/mm ²)	Elongation (%)	Impact ISO-V(J) +20°C
Typical values	M21	PWHT 690°C/1h	560	680	20	100

EXAMPLES OF MATERIALS TO BE WELDED

Steel grades	Standard	Type
Creep and hydrogen resistant steels	EN 10028-2	10CrMo 9-10
EN 10222-2	12CrMo 9-10Inm 304l	

APPLICATION ADVICE

Preheating welding joint acc. EN 1011-1, 200-250°C
Post weld heat treatment at 690-740°C

PACKAGING AND AVAILABLE SIZES

Diameter (mm)	1.0	1.2
15 Kg spool B300	X	X
Other sizes and packaging on request		

LNM 20 rev. C-EN26-01/02/16

LNM 304LSi

CLASSIFICATION

AWS A5.9	ER308LSi	A-Nr	8	Mat-Nr	1.4316
ISO 14343-A	G 19 9 L Si	F-Nr	6		
		9606 FM	5		

GENERAL DESCRIPTION

Solid wire with extra low carbon for welding austenitic CrNi-steels
With increased silicon for improved wettability

WELDING POSITIONS (ISO/ASME)



PA/1G



PB/2F



PC/2G



PD/4F



PE/4G



PF/3Gu

SHIELDING GASES (ACC. ISO 14175)

M12	Mixed gas Ar+ 0.5-5% CO ₂
M13	Mixed gas Ar+ 0.5-3% O ₂

APPROVALS

ABS	BV	DNV	GL	LR	TÜV
+	+	+	+	+	+

CHEMICAL COMPOSITION (W%) TYPICAL WIRE

C	Mn	Si	Cr	Ni	Mo
0.02	1.9	0.8	20	10	0.1

MECHANICAL PROPERTIES, TYPICAL, ALL WELD METAL

Typical values	Shielding gas	Condition	0.2% proof strength	Tensile strength	Elongation	Impact ISO-V(J)	
			[N/mm ²]	[N/mm ²]	(%)	-20°C	-196°C
	M12	AW	394	568	40	85	41

EXAMPLES OF MATERIALS TO BE WELDED

Steel grades	EN 10088-1/-2	EN 10213-4	Mat. Nr	ASTM/AISI A240/A312/A351	UNS
Extra low carbon [C < 0.03%]	X2CrNi19-11		1.4306	(TP)304 L CF-3	S30403 J92500
	X2CrNiN18-10		1.4311	(TP)304LN 302, 304	S30453 S30400
Medium carbon [C > 0.03%]	X4CrNi18-10		1.4301 1.4308	(TP)304 CF-8	S30409 J92600
		GX5CrNi19 10			
Ti-,Nb stabilized	X6CrNiTi18-10		1.4541	(TP)321 (TP)321H	S32100 S32109
	X6CrNiNb18-10		1.4550 1.4552	(TP)347 CF-8C	S34700 J92710
		GX5 CrNiNb 19 10			

PACKAGING AND AVAILABLE SIZES

Diameter (mm)	0.8	1.0	1.2
5 kg plastic spool S200	X	X	X
15 kg spool B5300	X	X	X
250 kg Accutrak® Drum			X

LNM 304LSi rev. C-EN24-01/02/16

Other sizes and packaging on request

All information in this data sheet is accurate to the best of our knowledge at the time of printing. Please refer to www.lincolnelectric.eu for any updated information.
Fumes: Safety Data Sheets (SDS) are available on our website.

LNM 304L

CLASSIFICATION

AWS A5.9	ER308L	A-Nr	8	Mat-Nr	1.4316
ISO 14343-A	G 19 9 L	F-Nr	6		
		9606 FM	5		

GENERAL DESCRIPTION

Solid wire with extra low carbon for welding austenitic CrNi-steels
High resistance to intergranular corrosion and oxidizing environments

WELDING POSITIONS (ISO/ASME)



PA/1G



PB/2F



PC/2G



PD/4F



PE/4G



PF/3Gu

SHIELDING GASES (ACC. ISO 14175)

M12	Mixed gas Ar+ 0.5-5% CO ₂
M13	Mixed gas Ar+ 0.5-3% O ₂

CHEMICAL COMPOSITION (W%) TYPICAL WIRE

C	Mn	Si	Cr	Ni	Mo
0.01	1.6	0.4	20	10	0.3

MECHANICAL PROPERTIES, TYPICAL, ALL WELD METAL

	Shielding gas	Condition	0.2% proof strength	Tensile strength	Elongation	Impact ISO-V(J)	
			(N/mm ²)	(N/mm ²)	(%)	+20°C	-196°C
Typical values	M12	AW	390	590	35	120	50

EXAMPLES OF MATERIALS TO BE WELDED

Steel grades	EN 10088-1/-2	EN 10213-4	Mat. Nr	ASTM/ACI A240/A312/A351	UNS
Extra low carbon [C < 0.03%]					
	X2CrNi19-11		1.4306	(TP)304 L	S30403
	X2CrNi18-10		1.4311	CF-3 (TP)304LN 302, 304	J92500 S30453 S30400
Medium carbon [C > 0.03%]					
	X4CrNi18-10		1.4301	(TP)304	S30409
		GX5CrNi19 10	1.4308	CF-8	J92600
Ti-,Nb stabilized					
	X6CrNiTi18-10		1.4541	(TP)321 (TP)321H	S32100 S32109
	X6CrNiNb18-10		1.4550	(TP)347	S34700
		GX5 CrNiNb 19 10	1.4552	CF-8C	J92710

PACKAGING AND AVAILABLE SIZES

Diameter (mm)	1.0	1.2
15 kg spool BS300	X	X
Other sizes and packaging on request		

LNM 304L: rev. C-EN24-01/02/16

All information in this data sheet is accurate to the best of our knowledge at the time of printing. Please refer to www.lincolnelectric.eu for any updated information.
Fumes: Safety Data Sheets (SDS) are available on our website.

LINCOLN
ELECTRIC
THE WELDING EXPERTS®

LNM 347Si

CLASSIFICATION

AWS A5.9	ER347Si	A-Nr	8	Mat-Nr	1.4551
ISO 14343-A	G 19 9 NbSi	F-Nr	6		
		9606 FM	5		

GENERAL DESCRIPTION

Solid wire for welding Ti or Nb stabilized stainless CrNi-steels
High resistance to intergranular corrosion and oxidizing environments

WELDING POSITIONS (ISO/ASME)



PA/1G



PB/2F



PC/2G



PD/4F



PE/4G



PF/3Gu

SHIELDING GASES (ACC. ISO 14175)

M12	Mixed gas Ar+ 0.5-5% CO ₂
M13	Mixed gas Ar+ 0.5-3% O ₂

APPROVALS

TÜV

DB

+

+

CHEMICAL COMPOSITION (W%) TYPICAL WIRE

C	Mn	Si	Cr	Ni	Mo	Nb
0.05	1.4	0.7	19.2	9.9	0.1	0.6

MECHANICAL PROPERTIES, TYPICAL, ALL WELD METAL

Typical values	Shielding gas	Condition	0.2% proof strength (N/mm ²)	Tensile strength (N/mm ²)	Elongation (%)	Impact ISO-V(J)	
						+20°C	-196°C
	M12	AW	460	650	35	100	40

EXAMPLES OF MATERIALS TO BE WELDED

Steel grades	EN 10088-1/-2	EN 10213-4	Mat. Nr	ASTM/ACI A240/A312/A351	UNS
Ti-,Nb stabilized					
	X6CrNiTi18-10		1.4541	(TP)321 (TP)321H	S32100 S32109
	X6CrNiNb18-10		1.4550	(TP)347 (TP)347h	S34700 S34709
		GX5 CrNiNb 19-10	1.4552	CF-8C	J92710
Non stabilized					
	X4CrNi18-10		1.4301	302 (TP)304	S30400
	X2CrNi19-11		1.4306	(TP)304L	S30403
		GX5 CrNi 19-10	1.4308 1.4312	CF-8 (TP)304H	J92600 S30409

PACKAGING AND AVAILABLE SIZES

Diameter (mm)	0.8	1.0	1.2
15 kg spool BS300	X	X	X

Other sizes and packaging on request

LNM 347Si:rev. C-EN23-01/02/16

LNM 316LSi

CLASSIFICATION

AWS A5.9	ER316LSi	A-Nr	8	Mat-Nr	1.4430
ISO 14343-A	G 19 12 3 LSi	F-Nr	6		
		9606 FM	5		

GENERAL DESCRIPTION

Solid wire with extra low carbon for welding stainless CrNiMo-steels
See also LNM 316L, high silicon for improved wettability

WELDING POSITIONS (ISO/ASME)



PA/1G

PB/2F

PC/2G

PD/4F

PE/4G

PF/3Gu

SHIELDING GASES (ACC. ISO 14175)

M12	Mixed gas Ar+ 0.5-5% CO ₂
M13	Mixed gas Ar+ 0.5-3% O ₂

APPROVALS

ABS	BV	DNV	GL	LR	TÜV
+	+	+	+	+	+

CHEMICAL COMPOSITION (W%) TYPICAL WIRE

C	Mn	Si	Cr	Ni	Mo
0.01	1.8	0.8	18.5	12.2	2.5

MECHANICAL PROPERTIES, TYPICAL, ALL WELD METAL

	Shielding gas	Condition	0.2% proof strength	Tensile strength	Elongation	Impact ISO-V(U)		
			[N/mm ²]	[N/mm ²]	[%]	+20°C	-120°C	-196°C
Typical values	M12	AW	452	580	30	150	70	44

EXAMPLES OF MATERIALS TO BE WELDED

Steel grades	EN 10088-1/-2	EN 10213-4	Mat. Nr	ASTM/ACI A240/A312/A351	UNS
Extra low carbon [C < 0.03%]					
	X2CrNiMo17-12-2		1.4404	(TP)316L CF-3M	S31603 J92800
	X2CrNiMo18-14-3		1.4435	(TP)316L	S31603
	X2CrNiMoN17-Ti-2		1.4406	(TP)316LN	S31653
	X2CrNiMoN17-13-3		1.4429		
Medium carbon [C > 0.03%]					
	X4CrNiMo17-12-2		1.4401	(TP)316	S31600
	X4CrNiMo17-13-3		1.4436		
	GX5CrNiMo19-11		1.4408	CF 8M	J92900
Ti-,Nb stabilized					
	X6CrNiMoTi17-12-2		1.4571	316 Ti	S31635
	X6CrNiMoNb17-12-2		1.4580	316 Cb	S31640
	X6CrNiNb18-10		1.4550	(TP)347	S34700
		GX5 CrNiNb 19-10	1.4552	CF-8C	J92710

PACKAGING AND AVAILABLE SIZES

Diameter (mm)	0.8	1.0	1.2	Other sizes and packaging on request
5 kg plastic spool S200	X	X		
15 kg spool BS300	X	X	X	

LNM 316LSi rev. C-EN24-01/02/16

All information in this data sheet is accurate to the best of our knowledge at the time of printing. Please refer to www.lincolnelectric.eu for any updated information.
Fumes: Safety Data Sheets (SDS) are available on our website.

LNM 318Si

CLASSIFICATION

AWS A5.9	ER318*	A-Nr	8	Mat-Nr	1.4576
ISO 14343-A	G 19 12 3 NbSi	F-Nr	6		
* Nearest classification		9606 FM	5		

GENERAL DESCRIPTION

Solid wire for welding Ti or Nb stabilized stainless CrNiMo-steels
High resistance to intergranular corrosion and general corrosion conditions

WELDING POSITIONS (ISO/ASME)



PA/1G

PB/2F

PC/2G

PD/4F

PE/4G

PF/3Gu

SHIELDING GASES (ACC. ISO 14175)

M12	Mixed gas Ar+ 0.5-5% CO ₂
M13	Mixed gas Ar+ 0.5-3% O ₂

APPROVALS

TÜV

+

CHEMICAL COMPOSITION (W%) TYPICAL WIRE

C	Mn	Si	Cr	Ni	Mo	Nb
0.05	1.4	0.7	18.6	11.7	2.5	0.7

MECHANICAL PROPERTIES, TYPICAL, ALL WELD METAL

	Shielding gas	Condition	0.2% proof strength [N/mm ²]	Tensile strength [N/mm ²]	Elongation [%]	Impact ISO-V(J) +20°C
Typical values	M12	AW	410	630	35	100

EXAMPLES OF MATERIALS TO BE WELDED

Steel grades	EN 10088-1/-2	EN 10213-4	Mat. Nr	ASTM/ACI A240/A312/A351	UNS
Extra low carbon [C < 0.03%]					
	X2CrNiMo17-12-2		1.4404	(TP)316L CF-3M	S31603 J92800
	X2CrNiMo18-14-3		1.4435	(TP)316L	S31603
	X2CrNiMoN17-11-2		1.4406	(TP)316LN	S31653
	X2CrNiMoN17-13-3		1.4429		
Medium carbon [C > 0.03%]					
	X4CrNiMo17-12-2		1.4401	(TP)316	S31600
	X4CrNiMo17-13-3		1.4436		
		G-X5CrNiMo19-11	1.4408	CF 8M	J92900
Ti-,Nb stabilized					
	X6CrNiMoTi17-12-2		1.4571	316Ti	S31635
	X6CrNiMoNb17-12-2		1.4580	316Cb	S31640
	X6CrNiNb18-10		1.4550	(TP)347	S34700
		G-X5CrNiNb 19-10	1.4552	CF-8C	J92710

PACKAGING AND AVAILABLE SIZES

Diameter [mm]	1.0	1.2
15 kg spool BS300	X	X

Other sizes and packaging on request

LNM 318Si rev. C-EN23-01/02/16

All information in this data sheet is accurate to the best of our knowledge at the time of printing. Please refer to www.lincolnelectric.eu for any updated information.
Fumes: Safety Data Sheets (SDS) are available on our website.

LNМ 4439Mn

CLASSIFICATION

ISO 14343-A	G 18 16 5 N L*	A-Nr	9*	Mat-Nr	1.4453
		F-Nr	6*		
* Nearest classification		9606 FM	5		

GENERAL DESCRIPTION

Solid wire for welding AISI 317L, 317LN or equivalent stainless steels
 For welding 316L if increased molybdenum content is important
 High resistance to pitting, intergranular and stress corrosion
 Fully austenitic weld metal

WELDING POSITIONS (ISO/ASME)



PA/1G



PB/2F



PC/2G



PD/4F



PE/4G



PF/3Gu

SHIELDING GASES (ACC. ISO 14175)

M12	Mixed gas Ar+ 0.5-5% CO ₂
M13	Mixed gas Ar+ 0.5-3% O ₂

CHEMICAL COMPOSITION (W%) TYPICAL WIRE

C	Mn	Si	Cr	Ni	Mo	N
0.01	5.2	0.4	19	17	4.0	0.15

MECHANICAL PROPERTIES, TYPICAL, ALL WELD METAL

Typical values	Shielding gas	Condition	0.2% proof strength	Tensile strength	Elongation [%]	Impact ISO-V(J)	
	M12		AW	[N/mm ²]		[N/mm ²]	+20°C
			400	600	30	70	32

EXAMPLES OF MATERIALS TO BE WELDED

Steel grades	EN 10088-1/-2	EN 10213-4	Mat. Nr	ASTM/AISI	UNS
Fully austenitic CrNiMo corrosion resistant steels					
	X2CrNiMoN17-11-2		1.4406	(TP)316LN	S31653
	X2CrNiMoN17-13-3		1.4429	(TP)316LN	S31653
	X2CrNiMo18-14-3		1.4435	(TP)316L	S31603
	X2CrNiMo18-15-4		1.4438	317L	S31725
	X2CrNiMoN17-13-5		1.4439	317LN	S31726
	G-X2CrNiMoN17-13-4	G-X2CrNiMo17-13-4	1.4446		
	G-X6CrNiMo17-13	G-X6CrNiMo17-13	1.4448		

PACKAGING AND AVAILABLE SIZES

Diameter (mm)	1.2
15 kg spool BS300	X

Other sizes and packaging on request

LNМ 4439Mn; rev. C-EN24-01/02/16

All information in this data sheet is accurate to the best of our knowledge at the time of printing. Please refer to www.lincolnelectric.eu for any updated information.
 Fumes: Safety Data Sheets (SDS) are available on our website.

LINCOLN
ELECTRIC
 THE WELDING EXPERTS®

GMAW

LNM 4455

CLASSIFICATION

AWS A5.9	ER316LMn	A-Nr	9*	Mat-Nr	1.4455
ISO 14343-A	G 20 16 3 Mn L	F-Nr	6*		
		9606 FM	5		

GENERAL DESCRIPTION

Solid wire for welding fully austenitic CrNiMnMo stainless steels and low temperature steels
Not susceptible for hot cracking

WELDING POSITIONS (ISO/ASME)



PA/1G



PB/2F



PC/2G



PD/4F



PE/4G



PF/3Gu

SHIELDING GASES (ACC. ISO 14175)

M12	Mixed gas Ar+ 0.5-5% CO ₂
M13	Mixed gas Ar+ 0.5-3% O ₂

APPROVALS

TÜV

+

CHEMICAL COMPOSITION (W%) TYPICAL WIRE

C	Mn	Si	Cr	Ni	Mo	N
0.015	7	0.4	20	16	3.0	0.15

MECHANICAL PROPERTIES, TYPICAL, ALL WELD METAL

	Shielding gas	Condition	0.2% proof strength [N/mm ²]	Tensile strength [N/mm ²]	Elongation [%]	Impact ISO-V[J] -196°C
Typical values	M12	AW	400	600	30	50

EXAMPLES OF MATERIALS TO BE WELDED

Steel grades	EN 10088-1/-2	EN 10213-4	Mat. Nr	ASTM/ACI	UNS
N-alloyed stainless CrNi- and CrNiMo steels	EN 10088-1/-2	X2CrNiN18-10	1.4311	(TP)304LN	S30453
		X2CrNiMoN17-11-2	1.4406	(TP)316LN	S31653
		X2CrNiMoN17-13-3	1.4429		
		X2CrNiMoN17-13-5	1.4439	317LN	S31726
Austenitic anti-magnetic steels	SEW 390	X2CrNiMoN22-15	1.3951		
		X2CrNiMoN18-14-3	1.3952		
		X2CrNiMo18-15	1.3953		
		X8CrMnNi18-8	1.3965		
Low temperature steels	SEW 685	G-X6CrNi18-10	1.6902		
		G-X5CrNiN18-10	1.6905		
	EN 10028-4	12 Ni 14	1.5637		
		X12Ni5	1.5680		

PACKAGING AND AVAILABLE SIZES

Diameter [mm]	1.0	1.2
15 kg spool BS300	X	X

Other sizes and packaging on request

LNM 4455: rev. C-EN22-01/02/16

LNM 4362

CLASSIFICATION

No EN or AWS standard	A-Nr	9*	Mat-Nr	1.4362
	F-Nr	6*		
	9606 FM	5		

GENERAL DESCRIPTION

Solid wire for welding Lean Duplex stainless steels
Corrosion resistance is equal to 316L in most applications

WELDING POSITIONS (ISO/ASME)



PA/1G



PB/2F



PC/2G



PD/4F



PE/4G



PF/3Gu

SHIELDING GASES (ACC. ISO 14175)

M12	Mixed gas Ar+ 0.5-5% CO ₂
M13	Mixed gas Ar+ 0.5-3% O ₂

CHEMICAL COMPOSITION [W%] TYPICAL WIRE

C	Mn	Si	Cr	Ni	Mo	N
0.01	1.4	0.6	23	7	0.3	0.14

MECHANICAL PROPERTIES, TYPICAL, ALL WELD METAL

	Shielding gas	Condition	0.2% proof strength [N/mm ²]	Tensile strength [N/mm ²]	Elongation [%]	Impact ISO-V(J)	
						+20°C	-20°C
Typical values	M12	AW	525	710	25	170	150

EXAMPLES OF MATERIALS TO BE WELDED

Steel grades	EN 10088-1/-2	Mat. Nr	UNS
Duplex stainless steels	X2CrNiMoN21-5-1	1.4162	S32101
	X2CrNiN23-4	1.4362	S32304

PACKAGING AND AVAILABLE SIZES

Diameter (mm)	1.2
15 kg spool BS300	X

Other sizes and packaging on request

LNM 4362 - rev. C-EN05-01/02/16

All information in this data sheet is accurate to the best of our knowledge at the time of printing. Please refer to www.lincolnelectric.eu for any updated information. Fumes: Safety Data Sheets (SDS) are available on our website.

LINCOLN
ELECTRIC
THE WELDING EXPERTS®

LNM 4462

CLASSIFICATION

AWS A5.9	ER2209	A-Nr	8	Mat-Nr	1.4462
ISO 14343-A	G 22 93 N L	F-Nr	6		
		9606 FM	5		

GENERAL DESCRIPTION

Solid wire for welding duplex stainless steels
High resistance to general corrosion, pitting and stress corrosion conditions

WELDING POSITIONS (ISO/ASME)



PA/1G



PB/2F



PC/2G



PD/4F



PE/4G



PF/3Gu

SHIELDING GASES (ACC. ISO 14175)

M12	Mixed gas Ar+ 0.5-5% CO ₂
M13	Mixed gas Ar+ 0.5-3% O ₂

APPROVALS

BV	GL	TÜV
2209	44625	+

CHEMICAL COMPOSITION (W%) TYPICAL WIRE

C	Mn	Si	Cr	Ni	Mo	N
0.01	1.3	0.5	23	8.5	3.0	0.15

MECHANICAL PROPERTIES, TYPICAL, ALL WELD METAL

	Shielding gas	Condition	0.2% proof strength	Tensile strength	Elongation	Impact ISO-V(J)	
			(N/mm ²)	(N/mm ²)	(%)	+20°C	-46°C
Typical values	M12	AW	621	803	29	110	40

EXAMPLES OF MATERIALS TO BE WELDED

Steel grades	EN 10088-1/-2	Mat. Nr	UNS
Duplex stainless steels			
	X2CrNiMoN22-5-3	1.4462	S31803
		1.4417	S31500
	X2CrNiN23-4	1.4362	S32304
	X3CrNiMoN27-5-2	1.4460	S31200
	X2CrNiMoN21-5-1	1.4162	S32101

Dissimilar joints such as un- and low alloy steel to duplex stainless steel

PACKAGING AND AVAILABLE SIZES

Diameter (mm)	0.8	0.9	1.2	1.6
15 kg spool BS300	X	X	X	X
Other sizes and packaging on request				

LNM 4462: rev. C-EN25-12/05/16

All information in this data sheet is accurate to the best of our knowledge at the time of printing. Please refer to www.lincolnelectric.eu for any updated information. Fumes: Safety Data Sheets (SDS) are available on our website.

LNM 4500

CLASSIFICATION

AWS A5.9	ER385	A-Nr	9	Mat-Nr	1.4519
ISO 14343-A	G 20 25 5 Cu L	F-Nr	6		
		9606 FM	5		

GENERAL DESCRIPTION

Solid wire for welding of fully austenitic steels of type 20%Cr / 25%Ni / 4.5%Mo / 1.5%Cu
Highly corrosion resistant in sulphuric and phosphoric acid

WELDING POSITIONS (ISO/ASME)



PA/1G



PB/2F



PC/2G



PD/4F



PE/4G



PF/3Gu

SHIELDING GASES (ACC. ISO 14175)

M12	Mixed gas Ar+ 0.5-5% CO ₂
M13	Mixed gas Ar+ 0.5-3% O ₂

APPROVALS

TÜV

+

CHEMICAL COMPOSITION (W%) TYPICAL WIRE

C	Mn	Si	Cr	Ni	Mo	Cu
0.01	1.7	0.3	20	25	4.4	1.5

MECHANICAL PROPERTIES, TYPICAL, ALL WELD METAL

	Shielding gas	Condition	0.2% proof strength [N/mm ²]	Tensile strength [N/mm ²]	Elongation [%]	Impact ISO-V[J] +20°C
Typical values	M12	AW	350	610	35	100

EXAMPLES OF MATERIALS TO BE WELDED

Steel grades	EN 10088-1/-2	EN 10213-4	Mat. Nr
Fully austenitic NiCrMoCu and CrNiMoCu steels			
	X5NiCrMoCuTi20-18	G-X7NiCrMoCuNb25-20	1.4500
		G-X2NiCrMoCuN20-18	1.4506
		G-X2NiCrMoCuN25-20	1.4531
	X1NiCrMoCuN25-20-5		1.4536
		G-X7CrNiMoCuNb18-18	1.4539
	X5NiCrMoCuNb22-18		1.4585
			1.4586

PACKAGING AND AVAILABLE SIZES

Diameter (mm)	1.2
15 kg spool BS300	X

Other sizes and packaging on request

LNM 4500 rev. C-EN23-01/02/16

LNM 2507

CLASSIFICATION

AWS A5.9	ER2594	A-Nr	8
ISO 14343-A	G 25 9 4 N L	F-Nr	6
		9606 FM	5

GENERAL DESCRIPTION

The Superduplex 2507 is used when good corrosion resistance, stress corrosion cracking and pitting corrosion are a concern. It is used for welding austenitic-ferritic stainless alloys of the 25%Cr 7%Ni 4%Mo low-C types.

WELDING POSITIONS (ISO/ASME)



SHIELDING GASES (ACC. ISO 14175)

M12	Mixed gas Ar+ 0.5-5% CO ₂
M13	Mixed gas Ar+ 0.5-3% O ₂

CHEMICAL COMPOSITION (W%) TYPICAL WIRE

C	Mn	Si	Cr	Ni	Mo	Cu	Nb	P	S	V	W	N
0.03	2.5	1.0	24.0-27.0	8.0-10.5	2.5-4.5	0.05	0.03	0.03	0.02	0.1	1.0	0.20-0.30

MECHANICAL PROPERTIES, TYPICAL, ALL WELD METAL

	Shielding gas	Condition	Yield strength [N/mm ²]	Tensile strength [N/mm ²]	Elongation [%]	Impact ISO-V(J) -40°C
Typical values	M12	AW	650	850	23	55

EXAMPLES OF MATERIALS TO BE WELDED

Steel grades	ASTM	UNS
25%Cr Superduplex	A182 F53, F55 BS EN 10088-2 X2CrNiMoN25-7-4 (1.4410) SAF 2507(Sandvik/Avesta) Uranus 47N(CLI)	S32750, S32760
Casting	A890 Gr5A, 6A ACI CE3MN	J93404

APPLICATION ADVICE

Offshore Oil/Gas, chemical and petrochemical process industries, pipework systems, flowlines, paper industry, manifolds, etc. Preheat is not generally required. Interpass temperature 150 \pm max is recommended. Heat input in the range 1.0-2.0kJ/mm, depending on material thickness should be acceptable but most codes restrict the max to 1.5 or 1.75kJ/mm.

PACKAGING AND AVAILABLE SIZES

Diameter (mm)	1.0
15 kg spool B300	X

Other sizes and packaging on request

LNM 2507: rev. C-EN01-01/02/16

LNM 309LSi

CLASSIFICATION

AWS A5.9	ER309LSi	A-Nr	8	Mat-Nr	1.4332
ISO 14343-A	G 23 12 LSi	F-Nr	6		
		9606 FM	5		

GENERAL DESCRIPTION

Solid wire for welding stainless steel to carbon steel
With high silicon for improved wettability

WELDING POSITIONS (ISO/ASME)



PA/1G



PB/2F



PC/2G



PD/4F



PE/4G



PF/3Gu

SHIELDING GASES (ACC. ISO 14175)

M12	Mixed gas Ar+ 0.5-5% CO ₂
M13	Mixed gas Ar+ 0.5-3% O ₂

APPROVALS

ABS	BV	DB	DNV	GL	LR	TÜV
+	+	+	+	+	+	+

CHEMICAL COMPOSITION (W%) TYPICAL WIRE

C	Mn	Si	Cr	Ni	Mo
0.02	1.8	0.8	23.3	13.8	0.14

MECHANICAL PROPERTIES, TYPICAL, ALL WELD METAL

	Shielding gas	Condition	0.2% proof strength	Tensile strength	Elongation	Impact ISO-V(J)	
			[N/mm ²]	[N/mm ²]	[%]	-20°C	+20°C
Typical values	M12	AW	436	582	37	80	87

EXAMPLES OF MATERIALS TO BE WELDED

Steel grades	EN 10088-1/-2	Mat. Nr	ASTM	UNS
Corrosion resistant cladsteels				
	X2CrNiN18-10	1.4311	(TP)304LN	S30453
	X2CrNi19-11	1.4306	(TP)304L	S30403
			CF-3	J92500
	X4CrNi18-10	1.4301	(TP)304	S30400

Dissimilar metals (mild and low alloy steel to stainless steel)
Build-up welding on mild and low alloy steel

PACKAGING AND AVAILABLE SIZES

Diameter [mm]	0.8	1.0	1.2	1.6
15 kg spool BS300	X	X	X	X
250 kg Accutrak® Drum		X	X	

Other sizes and packaging on request

LNM 309LSi rev. C-EN22-01/02/16

LNM 307

CLASSIFICATION

AWS A5.9	ER307*	A-Nr	8	Mat-Nr	1.4370
ISO 14343-A	G 18 8 Mn	F-Nr	6		
* Nearest classification		9606 FM	5		

GENERAL DESCRIPTION

Solid wire for welding austenitic and ferritic stainless steels with difficult weldability
Often used as a buffer layer for hardfacing applications

WELDING POSITIONS (ISO/ASME)



PA/1G



PB/2F



PC/2G



PD/4F



PE/4G



PF/3Gu

SHIELDING GASES (ACC. ISO 14175)

M12	Mixed gas Ar+ 0.5-5% CO ₂
M13	Mixed gas Ar+ 0.5-3% O ₂

APPROVALS

TÜV

+

CHEMICAL COMPOSITION (W%) TYPICAL WIRE

C	Mn	Si	Cr	Ni
0.07	71	0.8	18.6	8.0

MECHANICAL PROPERTIES, TYPICAL, ALL WELD METAL

	Shielding gas	Condition	0.2% proof strength [N/mm ²]	Tensile strength [N/mm ²]	Elongation [%]	Impact ISO-V[J] +20°C
Typical values	M12	AW	400	630	40	80

EXAMPLES OF MATERIALS TO BE WELDED

Various steel grades, such as:

- Armour plate
- Hardenable steels including steels difficult to weld
- Non-magnetic steels
- Work hardening austenitic manganese steels
- Dissimilar joints (CMn-steels to stainless steels)
- Exhaust systems

PACKAGING AND AVAILABLE SIZES

Diameter (mm)	0.8	1.0	1.2
15 kg spool BS300	X	X	X
250 kg Accutrak® Drum			X

LNM 307 rev. C-EN23-01/02/16

Other sizes and packaging on request

All information in this data sheet is accurate to the best of our knowledge at the time of printing. Please refer to www.lincolnelectric.eu for any updated information. Fumes: Safety Data Sheets (SDS) are available on our website.

LNM 304H

CLASSIFICATION

AWS A5.9	ER308H	A-Nr	8	Mat-Nr	1.4948
ISO 14343-A	G 19 9 H	F-Nr	6		
		9606 FM	5		

GENERAL DESCRIPTION

Solid wire for welding austenitic CrNi-steels
Especially for high temperature applications (up to 730°C)
Low sensitivity to precipitation of intermetallic phases

WELDING POSITIONS (ISO/ASME)



PA/1G



PB/2F



PC/2G



PD/4F



PE/4G



PF/3Gu

SHIELDING GASES (ACC. ISO 14175)

M12	Mixed gas Ar+ 0.5-5% CO ₂
M13	Mixed gas Ar+ 0.5-3% O ₂

CHEMICAL COMPOSITION (W%) TYPICAL WIRE

C	Mn	Si	Cr	Ni	Mo
0.07	1.9	0.4	20	9.2	0.1

MECHANICAL PROPERTIES, TYPICAL, ALL WELD METAL

	Shielding gas	Condition	0.2% proof strength (N/mm ²)	Tensile strength (N/mm ²)	Elongation (%)
Typical values	M12	AW	370	590	34

EXAMPLES OF MATERIALS TO BE WELDED

Steel grades	EN 10088-1/-2	EN 10213-4	Mat. Nr	ASTM/AISI	UNS
Medium carbon [C > 0.03%]	X4CrNi18-10		1.4301	(TP)304	S30400
		G-X5CrNi19-10	1.4308	(TP)304H	S30409
			1.4948	CF 8	J92600

PACKAGING AND AVAILABLE SIZES

Diameter (mm)	1.0	1.2
15 kg spool BS300	X	X

Other sizes and packaging on request

LNM 304H rev. C-EN23-01/02/16

All information in this data sheet is accurate to the best of our knowledge at the time of printing. Please refer to www.lincolnelectric.eu for any updated information.
Fumes: Safety Data Sheets (SDS) are available on our website.

LINCOLN
ELECTRIC
THE WELDING EXPERTS®

GMAW

LNM 309H

CLASSIFICATION

AWS A5.9	ER309	A-Nr	8	Mat-Nr	1.4829
		F-Nr	6		
		9606 FM	5		

GENERAL DESCRIPTION

Solid wire for high temperature applications like industrial furnaces
 High resistance to oxidation up to 1050°C
 High carbon content

WELDING POSITIONS (ISO/ASME)



PA/1G

PB/2F

PC/2G

PD/4F

PE/4G

PF/3Gu

SHIELDING GASES (ACC. ISO 14175)

M12	Mixed gas Ar+ 0.5-5% CO ₂
M13	Mixed gas Ar+ 0.5-3% O ₂

CHEMICAL COMPOSITION (W%) TYPICAL WIRE

C	Mn	Si	Cr	Ni	Mo
0.08	1.8	0.4	23.6	13.2	0.1

MECHANICAL PROPERTIES, TYPICAL, ALL WELD METAL

Typical values	Shielding gas	Condition	0.2% proof strength	Tensile strength	Elongation	Impact ISO-V(J)
			[N/mm ²]	[N/mm ²]	[%]	+20°C
	M12	AW	400	640	35	110

EXAMPLES OF MATERIALS TO BE WELDED

Steel grades	EN 10088-1/-2	EN 10213-4	Mat. Nr	ASTM/ACI	UNS
		G-X30CrSi6	1.4710		
	X10CrAl7		1.4713	502	
	X10CrAl13		1.4724	410/414-TP405-CA15	
		G-X40CrSi13	1.4729		
		G-X40CrSi17	1.4740		
	X10CrAl18		1.4742	430-TP430-CB30	
	X10CrAl24		1.4762	TP443	
		G25CrNiSi18-9	1.4825		J92502
		G-X40CrNiSi22-9			
	X15CrNiSi20-12		1.4828	TP309	S30900
		G-X25CrNiSi20-14	1.4832		
	X12CrNiTi18-9		1.4878		

PACKAGING AND AVAILABLE SIZES

Diameter (mm)	1.0	1.2
15 kg spool BS300	X	X
Other sizes and packaging on request		

LNM 309H: rev. C-EN22-01/02/16

All information in this data sheet is accurate to the best of our knowledge at the time of printing. Please refer to www.lincolnelectric.eu for any updated information. Fumes: Safety Data Sheets (SDS) are available on our website.

LNM 310

CLASSIFICATION

AWS A5.9	ER310	A-Nr	9	Mat-Nr	1.4812
ISO 14343-A	G 25 20	F-Nr	6		
		9606 FM	5		

GENERAL DESCRIPTION

Solid wire for welding heat resistant Cr- and CrNi-steels [25%Cr-20%Ni]
High resistance to oxidation and scaling up to approx. 1100°C

WELDING POSITIONS (ISO/ASME)



PA/1G



PB/2F



PC/2G



PD/4F



PE/4G



PF/3Gu

SHIELDING GASES (ACC. ISO 14175)

M12	Mixed gas Ar+ 0.5-5% CO ₂
M13	Mixed gas Ar+ 0.5-3% O ₂

CHEMICAL COMPOSITION (W%) TYPICAL WIRE

C	Mn	Si	Cr	Ni	Mo
0.1	1.7	0.45	26	21	0.1

MECHANICAL PROPERTIES, TYPICAL, ALL WELD METAL

	Shielding gas	Condition	0.2% proof strength [N/mm ²]	Tensile strength [N/mm ²]	Elongation [%]	Impact ISO-V(J) +20°C
Typical values	M12	AW	355	610	35	110

EXAMPLES OF MATERIALS TO BE WELDED

Steel grades	EN 10088-1/-2	EN 10213-4	Mat. Nr	ASTM/ACI	UNS
	X10CrAl24		1.4762		
		G-X25CrNiSi18-9	1.4825		
		G-X40CrNiSi22-9	1.4826		
	X15CrNiSi20-12		1.4828		
		G-X25CrNiSi20-14	1.4832		
	X15CrNiSi25-20		1.4841	310S	S31008
				CK20	J94202
	X12CrNi25-21		1.4845		
		G-X40CrNiSi 25-20	1.4848	HK40	

PACKAGING AND AVAILABLE SIZES

Diameter (mm)	1.0	1.2
15 kg spool BS300	X	X

Other sizes and packaging on request

LNM 310: rev. C-EN23-01/02/16

All information in this data sheet is accurate to the best of our knowledge at the time of printing. Please refer to www.lincolnelectric.eu for any updated information.
Fumes: Safety Data Sheets (SDS) are available on our website.

LINCOLN
ELECTRIC
THE WELDING EXPERTS®

LNM 312

CLASSIFICATION

AWS A5.9	ER312	A-Nr	8	Mat-Nr	1.4337
ISO 14343-A	G 29 9	F-Nr	6		
		9606 FM	5		

GENERAL DESCRIPTION

Solid wire for welding heat resistant Cr- and CrNi-steels [25%Cr-20%Ni]
High resistance to oxidation and scaling up to approx. 1100°C

WELDING POSITIONS (ISO/ASME)



PA/1G



PB/2F



PC/2G



PD/4F



PE/4G



PF/3Gu

SHIELDING GASES (ACC. ISO 14175)

M12	Mixed gas Ar+ 0.5-5% CO ₂
M13	Mixed gas Ar+ 0.5-3% O ₂

CHEMICAL COMPOSITION (W%) TYPICAL WIRE

C	Mn	Si	Cr	Ni
0.1	1.8	0.4	30.7	8.9

MECHANICAL PROPERTIES, TYPICAL, ALL WELD METAL

	Shielding gas	Condition	0.2% proof strength [N/mm ²]	Tensile strength [N/mm ²]	Elongation [%]	Impact ISO-V(J) +20°C
Typical values	M12	AW	355	610	35	110

EXAMPLES OF MATERIALS TO BE WELDED

Steel grades	EN 10088-1/-2	EN 10213-4	Mat. Nr	ASTM/ACI	UNS
	X10CrAl24		1.4762		
		G-X25CrNiSi18-9	1.4825		
		G-X40CrNiSi22-9	1.4826		
	X15CrNiSi20-12		1.4828		
		G-X25CrNiSi20-14	1.4832		
	X15CrNiSi25-20		1.4841	310S	S31008
				CK20	J94202
	X12CrNi25-21		1.4845		
		G-X40CrNiSi 25-20	1.4848	HK40	

PACKAGING AND AVAILABLE SIZES

Diameter (mm)	1.0	1.2
15 kg spool BS300	X	X

Other sizes and packaging on request

LNM 312: rev. C-EN02-01/02/16

LNM NiCr 31/27

CLASSIFICATION

AWS A5.9	ER383	A-Nr	9	Mat-Nr	1.4563
ISO 14343-A	G 27 31.4 Cu L	F-Nr	6		
		9606 FM	5		

GENERAL DESCRIPTION

Solid wire for welding of Cu-alloyed NiCrMo-steels
 Excellent resistance to general corrosion, pitting and stress corrosion in acid and alkaline environments
 Especially for applications in phosphoric and sulphuric acid

WELDING POSITIONS (ISO/ASME)



PA/1G



PB/2F



PC/2G



PD/4F



PE/4G



PF/3Gu

SHIELDING GASES (ACC. ISO 14175)

I1	Inert gas Ar (100%)
I3	Inert gas Ar+ 0.5-95% He

CHEMICAL COMPOSITION (W%) TYPICAL WIRE

C	Mn	Si	Ni	Cr	Mo	Cu
0.01	1.6	1.0	31	27	3.5	1.0

MECHANICAL PROPERTIES, TYPICAL, ALL WELD METAL

Typical values	Shielding gas	Condition	0.2% proof strength	Tensile strength	Elongation	Impact ISO-V(J)	
			[N/mm ²]	[N/mm ²]	[%]	+20°C	-196°C
	I1	AW	440	640	38	100	50

EXAMPLES OF MATERIALS TO BE WELDED

Steel grades	EN 10088-1/2	Mat. Nr	ASTM/ACI	UNS
Copper alloy CrNiMo and NiCrMo-steels				
	X1NiCrMoCu31-27-4	1.4563		N08028
	X1NiCrMoCu25-20-5	1.4539	Alloy 904L	N08904
	DIN 17744			
	NiCr 21 Mo	2.4858	Alloy 825	N08825
	NiCr 21 Mo 6Cu	2.6410	Alloy 825 h Mo	N08821
	X3NiCrCuMoTi27-23	1.4503		

PACKAGING AND AVAILABLE SIZES

Diameter [mm]	1.2
15 kg spool BS300	X

Other sizes and packaging on request

LNM NiCr 31/27: rev. C-EN23-01/02/16

LNM NiCro 60/20

CLASSIFICATION

AWS A5.14	ERNiCrMo-3	A-Nr	-	Mat-Nr	2.4831
ISO 18274	S Ni 6625 (NiCr22Mo9Nb)	F-Nr	43		
		9606 FM	6		

GENERAL DESCRIPTION

Solid wire for welding of nickel alloys
 Extreme resistance to various corrosion forms
 High chromium and molybdenum content

WELDING POSITIONS (ISO/ASME)



PA/1G

PB/2F

PC/2G

PD/4F

PE/4G

PF/3Gu

SHIELDING GASES (ACC. ISO 14175)

I1	Inert gas Ar (100%)
I3	Inert gas Ar+ 0.5-95% He

CHEMICAL COMPOSITION (W%) TYPICAL WIRE

C	Mn	Si	Ni	Cr	Mo	Nb	Fe
0.02	0.06	0.07	64	21.9	9	3.5	0.4

MECHANICAL PROPERTIES, TYPICAL, ALL WELD METAL

Typical values	Shielding gas		Condition	0.2% proof strength [N/mm ²]	Tensile strength [N/mm ²]	Elongation [%]	Impact ISO-V(J)	
	I1	AW		520	770	34	+20°C	-196°C
							80	60

EXAMPLES OF MATERIALS TO BE WELDED

Ni-alloy grades	DIN/EN	Mat. Nr	ASTM/ACI	UNS
NiCrMo-steel Type alloy 625 and welding dissimilar high NiCrMo-steels for corrosion and heat resisting purposes				
	X1NiCrMoCuN25-20-6	1.4529	Alloy 925	N08925
	X1NiCrMoCu25-20-5	1.4539	Alloy 904L	N08904
	X1CrNiMoCuN20-18-7	1.4547	Alloy 254	S31254
	X2NiCrAlTi32-20	1.4558	Alloy 800L	N08800
	G-X10NiCrNb32-20	1.4859		
	X10NiCrAlTi32-20	1.4876	Alloy 800/800H	N08800/-10
	NiCr22Mo6Cu	2.4618	Alloy G	N06007
	NiCr22Mo7Cu	2.4619	Alloy G-3	N06985
	NiCr21Mo6Cu	2.4641	Alloy 825hMo	N08821
	NiCr20CuMo	2.4660	Alloy 20	N08020
	NiCr15Fe	2.4816	B168-Alloy 600	N06600
	NiCr22Mo9Nb	2.4856	B443-Alloy 625	N06625
	NiCr21Mo	2.4858	B424-Alloy 825	N08825
	NiCr20Ti	2.4951	Alloy 75	N06075
	NiCr20TiAl	2.4952	Alloy 80A	N07080
Low alloy steels				
	10Ni14 (3.5% Ni)	1.5637	ASTM A333 Grade 3	-
	12Ni19, X12Ni5	1.5680	-	K41583
9% Ni-steel for LNG storage tanks				
	X8Ni9	1.5662	A353/A353M	-
	X8Ni9 / 8%Ni	1.5662	A553/A553M Type I/II	- / K71340

PACKAGING AND AVAILABLE SIZES

Diameter [mm]	0.8	1.0	1.2
15 kg spool BS300	X	X	X

LNM NiCro 60/20: rev. C-EN23-01/02/16

All information in this data sheet is accurate to the best of our knowledge at the time of printing. Please refer to www.lincolnelectric.eu for any updated information. Fumes: Safety Data Sheets (SDS) are available on our website.

LNM NiCro 70/19

CLASSIFICATION

AWS A5.14	ERNiCr-3	A-Nr	-	Mat-Nr	2.4806
ISO 18274	S Ni 6082 (NiCr20Mn3Nb)	F-Nr	43		
		9606 FM	6		

GENERAL DESCRIPTION

Solid wire for welding nickel based alloys, dissimilar metals and cladding
High resistance to oxidation and high impact toughness at low temperature

WELDING POSITIONS (ISO/ASME)



PA/1G



PB/2F



PC/2G



PD/4F



PE/4G



PF/3Gu

SHIELDING GASES (ACC. ISO 14175)

I1	Inert gas Ar (100%)
I3	Inert gas Ar+ 0.5-95% He

APPROVALS

TÜV

+

CHEMICAL COMPOSITION (W%) TYPICAL WIRE

C	Mn	Si	Ni	Cr	Nb	Cu	Fe
0.03	3.1	0.08	72.5	20.5	2.6	0.01	0.8

MECHANICAL PROPERTIES, TYPICAL, ALL WELD METAL

Typical values	Shielding gas	Condition	0.2% proof strength	Tensile strength	Elongation	Impact ISO-V(J)	
			(N/mm ²)	(N/mm ²)	(%)	+20°C	-196°C
	I1	AW	390	640	35	150	50

EXAMPLES OF MATERIALS TO BE WELDED

Ni-alloy grades	BS3076	DIN 17744/17465	Mat. Nr	ASTM/ACI	UNS
		SEW 595		B366	
Ni-base high Cr alloy steel for low and high corrosion searching application					
	Na 14	NiCr15Fe	2.4816	B168-Alloy 600	N06600
		LC-NiCr15Fe	2.4817	Alloy 600L	N06600
		NiCr20Ti	2.4951	Alloy 75	
		NiCr20TiA1	2.4952	Alloy 80A	N07080
	Na 15	X10NiCrAlTi32-20	1.4876	Alloy 800/800H	N0800/10
		NiCr23Fe	2.4851	Alloy 601(H)	N06601
	Na 17	X12NiCrSi36-16	1.4864	330	N08330
		G-X40NiCrNb35-25	1.4852		
		G-X40NiCrSi35-25	1.4857	HP	

Un- and low alloy heat and creep resistant steel to stainless steel

APPLICATION ADVICE

Limit heat-input (HI<1.5kJ/mm) and interpass temperature (Ti<150°C)

PACKAGING AND AVAILABLE SIZES

Diameter (mm)	1.0	1.2
15 kg spool BS300	X	X
Other sizes and packaging on request		

LNM NiCro 70/19: rev. C-EN23-01/02/16

All information in this data sheet is accurate to the best of our knowledge at the time of printing. Please refer to www.lincolnelectric.eu for any updated information.
Fumes: Safety Data Sheets (SDS) are available on our website.

LINCOLN
ELECTRIC
THE WELDING EXPERTS®

GMAW

LNM NiTi

CLASSIFICATION

AWS A5.14	ERNi1	A-Nr	-	Mat-Nr	2.4155
ISO 18274	S Ni 2061 (NiTi3)	F-Nr	41		
		9606 FM	6		

GENERAL DESCRIPTION

Solid wire for welding pure nickel and nickel alloys and joining these materials with unalloy/low alloy steel
Suitable for surfacing carbon steels

WELDING POSITIONS (ISO/ASME)



PA/1G



PB/2F



PC/2G



PD/4F



PE/4G



PF/3Gu

SHIELDING GASES (ACC. ISO 14175)

I1	Inert gas Ar (100%)
I3	Inert gas Ar+ 0.5-95% He

APPROVALS

TÜV

+

CHEMICAL COMPOSITION (W%) TYPICAL WIRE

C	Mn	Si	Ni	Ti	Fe
0.02	0.4	0.2	bal.	3.1	0.06

MECHANICAL PROPERTIES, TYPICAL, ALL WELD METAL

	Shielding gas	Condition	0.2% proof strength (N/mm ²)	Tensile strength (N/mm ²)	Elongation (%)	Impact ISO-V(J) +20°C
Typical values	I1	AW	250	460	35	120

EXAMPLES OF MATERIALS TO BE WELDED

DIN-classification	Mat. Nr	ASTM/ACI
Ni 99.6	2.4060	
Ni 99.8	2.4050	
Ni 99.6Si	2.4056	
Ni 99.4Fe	2.4062	
Ni 99.2	2.4066	Alloy 200
LC-Ni 99	2.4068	Alloy 201
LC-Ni 99.6	2.4061	Alloy 205
NiMn 10	2.4108	
NiMn 5	2.4116	

PACKAGING AND AVAILABLE SIZES

Diameter (mm) 1.2

15 kg spool BS300 X

Other sizes and packaging on request

LNM NiTi: rev. C-EN23-01/02/16

LNM NiFe

CLASSIFICATION

AWS A5.15	ENiFe-CI	A-Nr	-	Mat-Nr	2.4560
ISO 1071	S NiFe-CI	F-Nr	-		
		9606 FM	6		

GENERAL DESCRIPTION

Solid wire for butt welds and hardfacing application in cast iron
 Suitable for dissimilar joints cast iron/steel
 Hardness approximately 200HB
 Optimal welding characteristics

WELDING POSITIONS (ISO/ASME)



PA/1G



PB/2F



PC/2G



PD/4F



PE/4G



PF/3Gu

SHIELDING GASES (ACC. ISO 14175)

I1	Inert gas Ar (100%)
I3	Inert gas Ar+ 0.5-95% He

CHEMICAL COMPOSITION (W%) TYPICAL WIRE

C	Mn	Si	Ni	Cu	Fe
0.05	0.83	0.14	55	0.4	bal.

MECHANICAL PROPERTIES, TYPICAL, ALL WELD METAL

Typical hardness value

2 layers, AW approx. 200 HB

PACKAGING AND AVAILABLE SIZES

Diameter (mm) 1.2
 15 kg spool BS300 X
 Other sizes and packaging on request

LNM NiFe rev. C-EN2-01/02/16

LNM CuAl8

CLASSIFICATION

AWS A5.7	ERCuAl-A1	A-Nr	-	Mat-Nr	2.0921
EN 14640	S Cu 6100 (CuAl8)	F-Nr	36		
		9606 FM	-		

GENERAL DESCRIPTION

Solid wire for welding copper-aluminium alloys, as aluminium bronze
High resistance to corrosion and wear

WELDING POSITIONS (ISO/ASME)



PA/1G



PB/2F



PC/2G



PD/4F



PE/4G



PF/3Gu

SHIELDING GASES (ACC. ISO 14175)

I1	Inert gas Ar (100%)
I3	Inert gas Ar+ 0.5-95% He

GMAW

CHEMICAL COMPOSITION (W%) TYPICAL WIRE

Cu	Al	Mn
bal.	8	0.3

MECHANICAL PROPERTIES, TYPICAL, ALL WELD METAL

	Shielding gas	Condition	0.2% proof strength (N/mm ²)	Tensile strength (N/mm ²)	Elongation (%)	Hardness HB
Typical values	I1	AW	185	430	30	95

EXAMPLES OF MATERIALS TO BE WELDED

Cu-alloy grades	Standard	Type	Mat. Nr
Copper-aluminium wrought alloys	DIN 17665	CuAl5As	2.0918
		CuAl8	2.0920
Copper-aluminium cast alloys	DIN 1714	G-CuAl8Mn	2.0962

PACKAGING AND AVAILABLE SIZES

Diameter (mm)	0.8	1.0	1.2	1.6
12 kg spool B300	X	X	X	X

Other sizes and packaging on request

LNM CuAl8: rev. C-EN23-01/02/16

All information in this data sheet is accurate to the best of our knowledge at the time of printing. Please refer to www.lincolnelectric.eu for any updated information. Fumes: Safety Data Sheets (SDS) are available on our website.

LNM CuAl8Ni6

CLASSIFICATION

AWS A5.7	ERCuNiAl	A-Nr	-	Mat-Nr	2.0923
EN ISO 24373	S Cu 6328 (CuAl9Ni5)	F-Nr	37		
		9606 FM	-		

GENERAL DESCRIPTION

Solid wire for welding of cast and wrought, nickel-aluminium-bronze
High resistance to corrosion and wear (cavitation)

WELDING POSITIONS (ISO/ASME)



PA/1G



PB/2F



PC/2G



PD/4F



PE/4G



PF/3Gu

SHIELDING GASES (ACC. ISO 14175)

I1	Inert gas Ar (100%)
I3	Inert gas Ar+ 0.5-95% He

CHEMICAL COMPOSITION (W%) TYPICAL WIRE

Cu	Al	Mn	Ni	Fe
bal.	9.0	2.5	5.0	4.0

MECHANICAL PROPERTIES, TYPICAL, ALL WELD METAL

	Shielding gas	Condition	0.2% proof strength [N/mm ²]	Tensile strength [N/mm ²]	Elongation [%]	Hardness HB
Typical values	I1	AW	380	500	20	150

EXAMPLES OF MATERIALS TO BE WELDED

Cu-alloy grades as copper-aluminium alloys and copper-nickel-aluminium alloys with 7-9% Al

Typical applications :

- Ship fittings and propellers
- Power plant valves
- Intake screens
- Oil recovery pumps
- Propeller gear housings
- Marine propulsion systems
- Piping systems

PACKAGING AND AVAILABLE SIZES

Diameter [mm]	1.6
12 kg spool BS300	X
Other sizes and packaging on request	

LNM CuAl8Ni6: rev. C-EN05-01/02/16

LNM CuNi30

CLASSIFICATION

AWS A5.7	ERCuNi	A-Nr	-	Mat-Nr	2.0837
EN 14640	S Cu 7158 (CuNi30)	F-Nr	34		
		9606 FM	-		

GENERAL DESCRIPTION

Solid wire for welding copper-nickel alloys containing 10-30%Ni

WELDING POSITIONS (ISO/ASME)



PA/1G



PB/2F



PC/2G



PD/4F



PE/4G



PF/3Gu

SHIELDING GASES (ACC. ISO 14175)

I1	Inert gas Ar (100%)
I3	Inert gas Ar+ 0.5-95% He

CHEMICAL COMPOSITION (W%) TYPICAL WIRE

Cu	Ni	Mn
bal.	31	0.8

MECHANICAL PROPERTIES, TYPICAL, ALL WELD METAL

	Shielding gas	Condition	Yield strength (N/mm ²)	Tensile strength (N/mm ²)	Elongation (%)	Hardness HB
Typical values	I1	AW	220	380	30	70

EXAMPLES OF MATERIALS TO BE WELDED

Cu-alloy grades	Standard	Type	Mat. Nr	UNS
Copper-nickel wrought alloys				
DIN 17664	CuNi10Fe1Mn		2.0872	C 70600
	CuNi30Mn1Fe		2.0882	C 71500
	CuNi30Fe2Mn2		2.0883	C 71600
Copper-nickel cast alloys				
DIN 17658	G-CuNi10		2.0815	
	G-CuNi30		2.0835	

PACKAGING AND AVAILABLE SIZES

Diameter [mm] 1.2

15 kg spool BS300 X

Other sizes and packaging on request

LNM CuNi30: rev. C-EN25-01/02/16

LNM CuSn

CLASSIFICATION

AWS A5.7	ERCu	A-Nr	-	Mat-Nr	2.1006
EN 14640	Cu 1898 (CuSn1)	F-Nr	31		
		9606 FM	-		

GENERAL DESCRIPTION

Solid wire for GMA-welding of copper

WELDING POSITIONS (ISO/ASME)



PA/1G



PB/2F



PC/2G



PD/4F



PE/4G



PF/3Gu

SHIELDING GASES (ACC. ISO 14175)

I1	Inert gas Ar (100%)
I3	Inert gas Ar+ 0.5-95% He

CHEMICAL COMPOSITION (W%) TYPICAL WIRE

Cu	Mn	Si	Sn	Ni
bal.	0.2	0.3	0.8	0.1

MECHANICAL PROPERTIES, TYPICAL, ALL WELD METAL

Typical values	Shielding gas	Condition	0.2% proof strength	Tensile strength	Elongation	Hardness
			[N/mm ²]	[N/mm ²]	(%)	HB
	I1	AW	100	220	60	35

EXAMPLES OF MATERIALS TO BE WELDED

Cu-alloy grades	Standard	Type	Mat. Nr
Copper	DIN 1787	OF-Cu	2.0040
		SE-Cu	2.0070
		SW-Cu	2.0076
		SF-Cu	2.0090
Wrought low alloy copper alloys	DIN 17666	CuFe2P	2.1310
		CuSP	2.1498
		CuTeP	2.1546

PACKAGING AND AVAILABLE SIZES

Diameter [mm]	1.0	1.2
12 kg spool B300	X	X

LNM CuSn: rev. C-EN25-01/02/16

All information in this data sheet is accurate to the best of our knowledge at the time of printing. Please refer to www.lincolnelectric.eu for any updated information. Fumes: Safety Data Sheets (SDS) are available on our website.

LINCOLN
ELECTRIC
THE WELDING EXPERTS®

LNM CuSi3

CLASSIFICATION

AWS A5.7	ERCuSi-A	A-Nr	-	Mat-Nr	2.1461
EN ISO 24373	S Cu 6560 (CuSi3Mn)	F-Nr	32		
		9606 FM	-		

GENERAL DESCRIPTION

Solid wire for GMA-welding of low alloy copper grades
High temperature and corrosion resistant

WELDING POSITIONS (ISO/ASME)



PA/1G



PB/2F



PC/2G



PD/4F



PE/4G



PF/3Gu

SHIELDING GASES (ACC. ISO 14175)

I1	Inert gas Ar (100%)
B	Inert gas Ar+ 0.5-95% He

GMAW

CHEMICAL COMPOSITION (W%) TYPICAL WIRE

Cu	Sn	Mn	Si	Zn
bal.	0.1	1.0	3.0	0.1

MECHANICAL PROPERTIES, TYPICAL, ALL WELD METAL

	Shielding gas	Condition	Yield strength (N/mm ²)	Tensile strength (N/mm ²)	Elongation (%)	Hardness HB	Impact ISO-V(I) +20°C
Typical values	I1	AW	120	350	40	95	60

EXAMPLES OF MATERIALS TO BE WELDED

Copper, low alloy copper and copper-zinc alloys

PACKAGING AND AVAILABLE SIZES

Diameter (mm)	0.8	1.0	1.2
5 kg plastic spool S200	X		
12 kg spool BS300	X	X	X

Other sizes and packaging on request

LNM CuSi3: rev. C-EN03-01/02/16

SuperGlaze® MIG 1070

CLASSIFICATION

ISO 18273	S Al 1070 (Al99.7)	A-Nr	-
		F-Nr	21
		Mat-Nr	3.0259

GENERAL DESCRIPTION

Highly resistant to chemical corrosion and good crack resistance

Suitable for electrical and chemical applications utilizing aluminium base metal with little or no alloying elements

Like all 1xxx filler alloys, Al 1070 is one of the softest aluminium MIG wire and requires extra care to ensure good feeding

WELDING POSITIONS (ISO/ASME)



PA/1G



PB/2F



PC/2G



PD/4F



PE/4G



PF/3Gu

SHIELDING GASES (ACC. ISO 14175)

I1	Inert gas Ar (100%)
Flow rate	14.2 - 23.6L/min

CHEMICAL COMPOSITION (W%) TYPICAL WIRE

Al	Si	Fe	Cu	Mn	Mg	Cr	Zn	V	Ti	Be
min. 99.7	max. 0.2	max. 0.25	max. 0.04	max. 0.03	max. 0.03	0	max. 0.04	max. 0.05	max. 0.03	max. 0.0003

Notes : Unspecified elements should not exceed a total of 0.03%

MECHANICAL PROPERTIES, TYPICAL, ALL WELD METAL

	Shielding gas	Condition	Yield strength [N/mm ²]	Tensile strength [N/mm ²]	Elongation [%]
Typical values	I1	AW	20-30	65-80	29-35

PHYSICAL PROPERTIES

Melting range : 647 - 658°C

Density : approximately 2700 kg/m³

APPLICATIONS

Joining 1xxx alloys to themselves or other alloys

Bus Bars

Electrical Boxes

Heat Exchangers

Metallizing

Electro-technical, Chemical, Construction and Food Industry

PACKAGING AND AVAILABLE SIZES

Diameter (mm)	0.8	1.0	1.2	1.6	2.4
0.5 kg plastic spool S100	X	X	X	X	
7.26 kg spool S300	X	X	X	X	X
7.0 kg spool BS300	X	X	X	X	X
23-27 kg wooden reel		X	X	X	X
125 kg Accupak			X	X	
159 kg wooden reel		X	X	X	X
227 kg wooden reel		X	X	X	X

Superglaze® MIG 1070: rev. C-EN02-01/02/16

All information in this data sheet is accurate to the best of our knowledge at the time of printing. Please refer to www.lincolnelectric.eu for any updated information. Fumes: Safety Data Sheets (SDS) are available on our website.

LINCOLN
ELECTRIC
THE WELDING EXPERTS®

SuperGlaze® MIG 1100

CLASSIFICATION

AWS 5.10	ER1100	A-Nr	-
ISO 18273	S Al 1100 (Al99.0Cu)	F-Nr	21
EN 573.3	EN AW-Al99.0Cu	Mat-Nr	-

GENERAL DESCRIPTION

Highly resistant to chemical corrosion and good crack resistance

Suitable for electrical and chemical applications utilizing aluminium base metal with little or no alloying elements

Like all 1xxx filler alloys, Al 1100 is one of the softest aluminium MIG wire and requires extra care to ensure good feeding

WELDING POSITIONS (ISO/ASME)



PA/1G



PB/2F



PC/2G



PD/4F



PE/4G



PF/3Gu

SHIELDING GASES (ACC. ISO 14175)

I1	Inert gas Ar (100%)
Flow rate	14.2 - 23.6L/min

CHEMICAL COMPOSITION (W%) TYPICAL WIRE

Al	Si	Fe	Cu	Mn	Mg	Cr	Zn	Ti	Be
min. 99.0	A	A	0.05-0.20	max. 0.05	0	0	max. 0.10	0	max. 0.0003

Notes : A = Si+Fe max. 0.95

Notes : Unspecified elements should not exceed a total of 0.15%

MECHANICAL PROPERTIES, TYPICAL, ALL WELD METAL

	Shielding gas	Condition	Yield strength [N/mm ²]	Tensile strength [N/mm ²]	Elongation [%]
Typical values	I1	AW	20-30	65-80	29-35

PHYSICAL PROPERTIES

Melting range : 647 - 658°C

Density : approximately 2700 kg/m³

APPLICATIONS

Joining 1xxx alloys to themselves or other alloys

Bus Bars

Electrical Boxes

Heat Exchangers

Metallizing

Electro-technical, Chemical, Construction and Food Industry

PACKAGING AND AVAILABLE SIZES

Diameter (mm)	0.8	1.0	1.2	1.6	2.4
0.5 kg plastic spool S100	X	X	X	X	
7.26 kg spool S300	X	X	X	X	X
7.0 kg spool BS300	X	X	X	X	X
23-27 kg wooden reel		X	X	X	X
125 kg Accupak			X	X	
159kg wooden reel		X	X	X	X
227 kg wooden reel		X	X	X	X

Superglaze® MIG 1100: rev. C-EN02-01/02/16

All information in this data sheet is accurate to the best of our knowledge at the time of printing. Please refer to www.lincolnelectric.eu for any updated information. Fumes: Safety Data Sheets (SDS) are available on our website.

SuperGlaze® MIG 2319

CLASSIFICATION

AWS 5.10	ER2319	A-Nr	-
ISO 18273	S Al 2319 (AlCu6MnZrTi)	F-Nr	25
EN 573.3	EN AW-AlCu6Mn	Mat-Nr	-

GENERAL DESCRIPTION

Primarily used where weld joints are capable of being heat treated to high strength.
Provides higher strength and better ductility than 4xxx filler alloys when welding on 2xxx base materials
Provides superior resistance to stress corrosion cracking where high temperature properties are required

WELDING POSITIONS (ISO/ASME)



PA/1G



PB/2F



PC/2G



PD/4F



PE/4G



PF/3Gu

SHIELDING GASES (ACC. ISO 14175)

I1	Inert gas Ar (100%)
Flow rate	14.2 - 23.6L/min

CHEMICAL COMPOSITION (W%) TYPICAL WIRE

Al	Si	Fe	Cu	Mn	Mg	Cr	Zn	Ti	Be
bal.	max. 0.2	max. 0.3	5.8-6.8	0.2-0.4	max. 0.02	-	max. 0.1	0.1-0.2	max. 0.0003

Notes : Unspecified elements should not exceed a total of 0.15%

MECHANICAL PROPERTIES, TYPICAL, ALL WELD METAL

	Shielding gas	Condition	Yield strength (N/mm ²)	Tensile strength (N/mm ²)	Elongation (%)
Typical values	I1	AW	160-180	240-270	Approx. 3

PHYSICAL PROPERTIES

Melting range	: 543 - 643°C
Density	: approximately 2768 kg/m ³

APPLICATIONS

Aircraft applications
Spacecraft industry

PACKAGING AND AVAILABLE SIZES

Diameter (mm)	0.8	1.0	1.2	1.6
7.26 kg spool S300	X	X	X	X
7.0 kg spool BS300	X	X	X	X

Other sizes and packaging on request

SuperGlaze® MIG 2319 rev. C-EN01-01/02/16

SuperGlaze[®] MIG 4043

CLASSIFICATION

AWS 5.10	ER4043	A-Nr	-
ISO 18273	S Al 4043A (AlSi5)	F-Nr	23
EN 573.3	EN AW-AlSi5	Mat-Nr	3.2245

GENERAL DESCRIPTION

Designed for welding heat treatable base alloys and more specifically 6xxx Series Alloys
 Lower melting point and fluidity than 5xxx series filler alloys
 Low sensitivity to weld cracking with 6xxx base alloys
 Suitable for sustained elevated temperature service. i.e. above 650°C

WELDING POSITIONS (ISO/ASME)



SHIELDING GASES (ACC. ISO 14175)

I1	Inert gas Ar (100%)
Flow rate	14.2 - 23.6L/min

APPROVALS

ABS	DB	TÜV
+	+	+

CHEMICAL COMPOSITION (W%) TYPICAL WIRE

Al	Si	Fe	Cu	Mn	Mg	Cr	Zn	Ti	Be
bal.	4.5-6.0	max. 0.6	max. 0.3	max. 0.05	max. 0.05	-	max. 0.1	max. 0.2	max. 0.0003

Notes : Unspecified elements should not exceed a total of 0.15%

MECHANICAL PROPERTIES, TYPICAL, ALL WELD METAL

	Shielding gas	Condition	Yield strength (N/mm ²)	Tensile strength (N/mm ²)	Elongation (%)
Typical values	I1	AW	20-40	120-165	3-18

PHYSICAL PROPERTIES

Melting range : 573 - 625°C
Density : approximately 2680 kg/m³

APPLICATIONS

For welding 6XXX alloys, and most casting alloys
 Automotive components such as frame and drive shafts
 Bicycle frames

PACKAGING AND AVAILABLE SIZES

Diameter (mm)	0.8	0.9	1.0	1.2	1.6	2.4	Other sizes and packaging on request
0.5 kg plastic spool S100	X		X	X	X		
7.26 kg spool S300	X		X	X	X	X	
7.0 kg spool BS300	X		X	X	X	X	
23-27 kg wooden reel			X	X	X	X	
125kg Gem-Pak		X		X	X		
159kg wooden reel			X	X	X	X	
227 kg wooden reel			X	X	X	X	

Superglaze[®] MIG 4043: rev. C-EN24-01/02/16

All information in this data sheet is accurate to the best of our knowledge at the time of printing. Please refer to www.lincolnelectric.eu for any updated information. Fumes: Safety Data Sheets (SDS) are available on our website.

SuperGlaze® MIG 4047

CLASSIFICATION

AWS 5.10	ER4047	A-Nr	-
ISO 18273	S Al 4047 [AlSi12]	F-Nr	23
EN 573.3	EN AW-AlCu6Mn	Mat-Nr	3.2585

GENERAL DESCRIPTION

Lower melting point and higher fluidity than 4043 wires

Can be used as a substitute for 4043 to increase silicon content in the weld metal and minimize hot cracking and produce higher fillet weld shear strength

Can be used as a brazing alloy

WELDING POSITIONS (ISO/ASME)



PA/1G



PB/2F



PC/2G



PD/4F



PE/4G



PF/3Gu

SHIELDING GASES (ACC. ISO 14175)

It	Inert gas Ar (100%)
Flow rate	14.2 - 23.6L/min

CHEMICAL COMPOSITION (W%) TYPICAL WIRE

Al	Si	Fe	Cu	Mn	Mg	Cr	Zn	Ti	Be
bal.	11-13	max. 0.8	max. 0.30	max. 0.15	0.10	0	max. 0.20	0	max. 0.0003

Notes : Unspecified elements should not exceed a total of 0.15%

MECHANICAL PROPERTIES, TYPICAL, ALL WELD METAL

	Shielding gas	Condition	Yield strength [N/mm ²]	Tensile strength [N/mm ²]	Elongation [%]
Typical values	It	AW	60-80	130-190	5-20

PHYSICAL PROPERTIES

Melting range : 573 - 585°C

Density : approximately 2680 kg/m³

APPLICATIONS

For welding 6XXX alloys, and most casting alloys
Cryogenic tanks
Automotive components, radiators and air conditioning

PACKAGING AND AVAILABLE SIZES

Diameter [mm]	0.8	1.0	1.2	1.6	2.4	Other sizes and packaging on request
0.5 kg plastic spool S100	X	X	X	X		
7.26 kg spool S300	X	X	X	X	X	
7.0 kg spool BS300	X	X	X	X	X	
23-27 kg wooden reel		X	X	X	X	
136 kg Accupak			X	X		
159kg wooden reel		X	X	X	X	
227 kg wooden reel		X	X	X	X	

Superglaze® MIG 5087: rev. C-EN03-01/02/16

SuperGlaze® MIG 5087

CLASSIFICATION

		A-Nr	-
ISO 18273	S Al 5087 (AlMg _{4,5} MnZr)	F-Nr	22
EN 573.3	EN AW-AlMg _{4,5} MnZr	Mat-Nr	3.3546

GENERAL DESCRIPTION

Designed to meet the tensile strength requirements of high magnesium alloys
For base metals with a max. of 5% Mg
The presence of Zirconium produces a fine-grained weld metal structure
Reduced tendency of solidification cracking in highly restrained welds

WELDING POSITIONS (ISO/ASME)



PA/1G



PB/2F



PC/2G



PD/4F



PE/4G



PF/3Gu

SHIELDING GASES (ACC. ISO 14175)

I1	Inert gas Ar (100%)
I3	Inert gas Ar+ 0.5-95% He
Flow rate	14.2 - 23.6L/min

APPROVALS

GL	LR	DB	TÜV	WIWeb
+*	+*	+	+	+

**(Valid for I1 and I3 gases)*

CHEMICAL COMPOSITION (W%) TYPICAL WIRE

Al	Si	Fe	Cu	Mn	Mg	Cr	Zn	Ti	Zr	Be
bal.	max. 0.25	max. 0.4	max. 0.05	0.7-1.1	4.5-5.2	0.05-0.25	max. 0.25	max. 0.15	0.10-0.20	max. 0.0003

Notes : Unspecified elements should not exceed a total of 0.15%

MECHANICAL PROPERTIES, TYPICAL, ALL WELD METAL

	Shielding gas	Condition	Yield strength [N/mm ²]	Tensile strength [N/mm ²]	Elongation [%]
Typical values	I1	AW	125-140	275-300	17-30

PHYSICAL PROPERTIES

Melting range	: 568 - 638°C
Density	: approximately 2660 kg/m ³

APPLICATIONS

Marine fabrication and repair
Cryogenic tanks
Shipbuilding and other high strength structural aluminium applications

Railway Industry
Automotive Industry
Trailer Industry and Offshore

PACKAGING AND AVAILABLE SIZES

Diameter (mm)	0.8	1.0	1.2	1.6	2.4	Other sizes and packaging on request
0.5 kg plastic spool S100	X	X	X	X		
726 kg spool S300	X	X	X	X	X	
70 kg spool B5300	X	X	X	X	X	
23-27 kg wooden reel		X	X	X	X	
136 kg Accupak			X	X		
159kg wooden reel		X	X	X	X	
227 kg wooden reel		X	X	X	X	

Superglaze® MIG 5087: rev. C-EN03-01/0216

All information in this data sheet is accurate to the best of our knowledge at the time of printing. Please refer to www.lincolnelectric.eu for any updated information.
Fumes: Safety Data Sheets (SDS) are available on our website.

SuperGlaze® MIG 5183

CLASSIFICATION

AWS 5.10	ER5183	A-Nr	-
ISO 18273	S Al 5183 [AlMg4.5Mn0.7(A)]	F-Nr	22
EN 573.3	EN AW-AlMg4.5Mn	Mat-Nr	3.3548

GENERAL DESCRIPTION

Designed to meet the tensile strength requirements of magnesium alloys
For base materials 5083 and 5654

WELDING POSITIONS (ISO/ASME)



PA/1G



PB/2F



PC/2G



PD/4F



PE/4G



PF/3Gu

SHIELDING GASES (ACC. ISO 14175)

I1	Inert gas Ar (100%)
I3	Inert gas Ar+ 0.5-95% He
Flow rate	14.2 - 23.6L/min

APPROVALS

ABS	GL	LR	DB	TÜV	DNV	BV	WIWeb
+	+	+	+	+	+	+	+

CHEMICAL COMPOSITION (W%) TYPICAL WIRE

Al	Si	Fe	Cu	Mn	Mg	Cr	Zn	Ti	Be
bal.	max. 0.4	max. 0.4	max. 0.1	0.5-1.0	4.3-5.2	0.05-0.25	max. 0.25	max. 0.15	max. 0.0003

Notes : Unspecified elements should not exceed a total of 0.15%

MECHANICAL PROPERTIES, TYPICAL, ALL WELD METAL

	Shielding gas	Condition	Yield strength (N/mm ²)	Tensile strength (N/mm ²)	Elongation (%)
Typical values	I1	AW	125-165	270-290	16-25

PHYSICAL PROPERTIES

Melting range	: 568 - 638°C
Density	: approximately 2660 kg/m ³

APPLICATIONS

Marine fabrication and repair	Military Industry
Cryogenic tanks	Railway & Automotive Industry
Shipbuilding and other high strength structural aluminium applications	Trailer Industry and Offshore

PACKAGING AND AVAILABLE SIZES

Diameter (mm)	0.8	1.0	1.2	1.6	2.4	Other sizes and packaging on request
0.5 kg plastic spool S100	X	X	X	X		
726 kg spool S300	X	X	X	X	X	
70 kg spool BS300	X	X	X	X	X	
23-27 kg wooden reel		X	X	X	X	
136 kg Accupak				X		
159kg wooden reel		X	X	X	X	
227 kg wooden reel		X	X	X	X	

Superglaze® MIG 5183: rev. C-EN24-01/02/16

All information in this data sheet is accurate to the best of our knowledge at the time of printing. Please refer to www.lincolnelectric.eu for any updated information.
Fumes: Safety Data Sheets (SDS) are available on our website.

LINCOLN
ELECTRIC
THE WELDING EXPERTS®

GMAW

SuperGlaze® MIG 5356

CLASSIFICATION

AWS 5.10	ER5356	A-Nr	-
ISO 18273	S Al 5356 (AlMg5Cr(A))	F-Nr	22
EN 573.3	EN AW-AlMg5	Mat-Nr	3.3556

GENERAL DESCRIPTION

General purpose filler alloy for welding 5XXX series alloys when 276 MPa tensile strength is not required.
Excellent colour match after anodizing

WELDING POSITIONS (ISO/ASME)

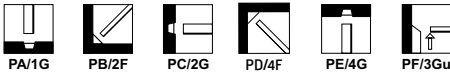

SHIELDING GASES (ACC. ISO 14175)

I1	Inert gas Ar (100%)
I3	Inert gas Ar+ 0.5-95% He
Flow rate	14.2 - 23.6L/min

APPROVALS

ABS	GL	LR	DB	TÜV	DNV	BV
+	+	+	+	+	+	+

CHEMICAL COMPOSITION (W%) TYPICAL WIRE

Al	Si	Fe	Cu	Mn	Mg	Cr	Zn	Ti	Be
bal.	max. 0.25	max. 0.4	max. 0.1	0.05-0.2	4.5-5.5	0.05-0.20	max. 0.1	0.06-0.2	max. 0.0003

Notes : Unspecified elements should not exceed a total of 0.15%

MECHANICAL PROPERTIES, TYPICAL, ALL WELD METAL

	Shielding gas	Condition	Yield strength (N/mm ²)	Tensile strength (N/mm ²)	Elongation [%]
Typical values	I1	AW	110-120	240-296	17-26

PHYSICAL PROPERTIES

Melting range	: 562 - 633°C
Density	: approximately 2640 kg/m ³

APPLICATIONS

Structural frames in the shipbuilding industry
Furniture. Storage tanks
Railway industry

Automotive and trailer industry
Formed truck panels
Automotive bumpers and supports

PACKAGING AND AVAILABLE SIZES

Diameter (mm)	0.8	0.9	1.0	1.2	1.6	2.4	Other sizes and packaging on request
0.5 kg plastic spool S100	X		X	X	X		
7.26 kg spool S300	X		X	X	X	X	
7.0 kg spool BS300	X		X	X	X	X	
23-27 kg wooden reel			X	X	X	X	
136kg Gem-Pak		X		X	X		
159kg wooden reel			X	X	X	X	
227 kg wooden reel			X	X	X	X	

Superglaze® MIG 5356: rev. C-EN24-01/02/16

All information in this data sheet is accurate to the best of our knowledge at the time of printing. Please refer to www.lincolnelectric.eu for any updated information. Fumes: Safety Data Sheets (SDS) are available on our website.

SuperGlaze® MIG 5356 TM™

CLASSIFICATION

AWS 5.10	ER5356	A-Nr	-
ISO 18273	S Al 5356 (AlMg5Cr)	F-Nr	22

GENERAL DESCRIPTION

Superior Wetting – Unparalleled bead profile and appearance which are critical for groove and fillet welds on aluminium trailer beds.
Enhanced Puddle Clarity and Control
Maximum Arc Performance and Stability

WELDING POSITIONS (ISO/ASME)



PA/1G

PB/2F

PC/2G

PD/4F

PE/4G

PF/3Gu

SHIELDING GASES (ACC. ISO 14175)

I1	Inert gas Ar (100%)
I3	Inert gas Ar+ 0.5-95% He
Flow rate	14.2 - 23.6L/min

APPROVALS

DB	TÜV	CWB
+	+	+

CHEMICAL COMPOSITION (W%) TYPICAL WIRE

Al	Si	Fe	Cu	Mn	Mg	Cr	Zn	Ti	Be
bal.	max. 0.25	max. 0.4	max. 0.1	0.05-0.2	4.5-5.5	0.05-0.20	max. 0.1	0.06-0.2	max. 0.0008

Notes : Unspecified elements should not exceed a total of 0.15%

MECHANICAL PROPERTIES, TYPICAL, ALL WELD METAL

	Shielding gas	Condition	Yield strength (N/mm ²)	Tensile strength (N/mm ²)	Elongation (%)
Typical values	I1	AW	110-120	240-296	17-26

PHYSICAL PROPERTIES

Melting range	: 562 - 633°C
Density	: approximately 2640 kg/m ³

APPLICATIONS

High speed groove welds on formed truck panels
Multi-pass fillet and lap welds on 6XXX series base materials
Robotic fillet welds on trailer tanks requiring minimal post-weld clean up

PACKAGING AND AVAILABLE SIZES

Diameter (mm)	0.9	1.2	1.6	Other sizes and packaging on request
70 kg spool BS300	X	X	X	
136kg Gem-Pak	X	X	X	

Superglaze® MIG 5356TM™: rev. C-EN02-01/02/16

All information in this data sheet is accurate to the best of our knowledge at the time of printing. Please refer to www.lincolnelectric.eu for any updated information. Fumes: Safety Data Sheets (SDS) are available on our website.

LINCOLN
ELECTRIC
THE WELDING EXPERTS®

SuperGlaze® MIG 5556

CLASSIFICATION

AWS 5.10	ER5556	A-Nr	-
ISO 18273	S Al 5556 (AlMg5MnTi)	F-Nr	22

GENERAL DESCRIPTION

Contains Increased amounts of magnesium and manganese.
Provides weld deposits matching tensile strengths for the 5xxx series alloys such as 5083 and 5684
The weld metal is sea water resistant

WELDING POSITIONS (ISO/ASME)



PA/1G

PB/2F

PC/2G

PD/4F

PE/4G

PF/3Gu

SHIELDING GASES (ACC. ISO 14175)

I1	Inert gas Ar (100%)
I3	Inert gas Ar+ 0.5-95% He
Flow rate	14.2 - 23.6L/min

APPROVALS

ABS

+

CHEMICAL COMPOSITION (W%) TYPICAL WIRE

Al	Si	Fe	Cu	Mn	Mg	Cr	Zn	Ti	Be
bal.	max. 0.25	max. 0.4	max. 0.1	0.5-1.0	4.7-5.5	0.05-0.20	max. 0.25	0.05-0.20	max. 0.0003

Notes : Unspecified elements should not exceed a total of 0.15%

MECHANICAL PROPERTIES, TYPICAL, ALL WELD METAL

	Shielding gas	Condition	Yield strength (N/mm ²)	Tensile strength (N/mm ²)	Elongation (%)
Typical values	I1	AW	125-145	275-295	17-25

PHYSICAL PROPERTIES

Melting range : 562 - 633°C

Density : approximately 2660 kg/m³

APPLICATIONS

Structural frames in the shipbuilding industry
Furnitures. Storage tanks
Railway Industry

Automotive and trailer Industry
Formed truck panels
Automotive bumpers and supports

PACKAGING AND AVAILABLE SIZES

Diameter (mm)	0.8	1.0	1.2	1.6	2.4	Other sizes and packaging on request
0.5 kg plastic spool S100	X	X	X	X		
726 kg spool S300	X	X	X	X	X	
70 kg spool BS300	X	X	X	X	X	
23-27 kg wooden reel		X	X	X	X	
136 kg Accupak			X	X		
159kg wooden reel		X	X	X	X	
227 kg wooden reel		X	X	X	X	

Superglaze® MIG 5556: rev. C-EN02-01/02/16

All information in this data sheet is accurate to the best of our knowledge at the time of printing. Please refer to www.lincolnelectric.eu for any updated information.
Fumes: Safety Data Sheets (SDS) are available on our website.

SuperGlaze® MIG 5556A

CLASSIFICATION

ISO 18273	S Al 5556A (AlMg5Mn)	A-Nr	-
EN 573.3	EN AW AlMg5Mn	F-Nr	22

GENERAL DESCRIPTION

High Magnesium alloyed wire

The elements are controlled to obtain increased weld strength over the 5356 alloy

Good ductility and improved crack resistance

WELDING POSITIONS (ISO/ASME)



PA/1G



PB/2F



PC/2G



PD/4F



PE/4G



PF/3Gu

SHIELDING GASES (ACC. ISO 14175)

I1	Inert gas Ar (100%)
I3	Inert gas Ar+ 0.5-95% He
Flow rate	14.2 - 23.6L/min

CHEMICAL COMPOSITION (W%) TYPICAL WIRE

Al	Si	Fe	Cu	Mn	Mg	Cr	Zn	Ti	Be
bal.	max. 0.25	max. 0.4	max. 0.1	0.6-1.0	5.0-5.5	0.05-0.20	max. 0.2	0.05-0.20	max. 0.0003

Notes : Unspecified elements should not exceed a total of 0.15%

MECHANICAL PROPERTIES, TYPICAL, ALL WELD METAL

	Shielding gas	Condition	Yield strength (N/mm ²)	Tensile strength (N/mm ²)	Elongation %
Typical values	I1	AW	125-140	275-300	15-17

PHYSICAL PROPERTIES

Melting range : 562 - 633°C

Density : approximately 2660 kg/m³

APPLICATIONS

Aircraft and Military Industry

PACKAGING AND AVAILABLE SIZES

Diameter (mm)	0.8	1.0	1.2	1.6	2.4
0.5 kg plastic spool S100	X	X	X	X	
726 kg spool S300	X	X	X	X	X
7.0 kg spool BS300	X	X	X	X	X
23-27 kg wooden reel		X	X	X	X
136 kg Accupak			X	X	
159kg wooden reel		X	X	X	X
227 kg wooden reel		X	X	X	X

Other sizes and packaging on request

SuperGlaze® MIG 5556A: rev. C-EN02-01/02/16

All information in this data sheet is accurate to the best of our knowledge at the time of printing. Please refer to www.lincolnelectric.eu for any updated information. Fumes: Safety Data Sheets (SDS) are available on our website.

LINCOLN
ELECTRIC
THE WELDING EXPERTS®

SuperGlaze® MIG 5754

CLASSIFICATION

		A-Nr	-
ISO 18273	S Al 5754 (AlMg3)	F-Nr	22
EN 573.3	EN AW AlMg3	Mat-Nr	3.3536

GENERAL DESCRIPTION

Magnesium alloyed aluminium for welding of alloys with a maximum of 3.5% Mg
 Good corrosion resistance and excellent colour match after anodizing
 Suitable for a wide range of applications in general construction and structural industry

WELDING POSITIONS (ISO/ASME)



PA/1G

PB/2F

PC/2G

PD/4F

PE/4G

PF/3Gu

SHIELDING GASES (ACC. ISO 14175)

I1	Inert gas Ar (100%)
I3	Inert gas Ar+ 0.5-95% He
Flow rate	14.2 - 23.6L/min

APPROVALS

TÜV

+

CHEMICAL COMPOSITION (W%) TYPICAL WIRE

Al	Si	Fe	Cu	Mn	Mg	Cr	Zn	Ti	Be	Mn+Cu
bal.	max. 0.4	max. 0.4	max. 0.1	max. 0.5	2.6-3.6	max. 0.3	max. 0.20	max. 0.15	max. 0.0003	0.10-0.6

Notes : Unspecified elements should not exceed a total of 0.15%

MECHANICAL PROPERTIES, TYPICAL, ALL WELD METAL

	Shielding gas	Condition	Yield strength (N/mm ²)	Tensile strength (N/mm ²)	Elongation [%]
Typical values	I1	AW	70-80	180-200	15-20

PHYSICAL PROPERTIES

Melting range : 580 - 642°C

Density : approximately 2660 kg/m³

APPLICATIONS

General Construction Industry
 Automotive bumpers and supports

PACKAGING AND AVAILABLE SIZES

Diameter (mm)	0.8	1.0	1.2	1.6	2.4	
0.5 kg plastic spool S100	X	X	X	X		Other sizes and packaging on request
726 kg spool S300	X	X	X	X	X	
70 kg spool BS300	X	X	X	X	X	
23-27 kg wooden reel		X	X	X	X	
136 kg Accupak			X	X		
159kg wooden reel		X	X	X	X	
227 kg wooden reel		X	X	X	X	

Superglaze® MIG 5754: rev. C-EN02-01/02/16

LNM 420FM

CLASSIFICATION

EN 14700 S Fe8 Mat-Nr 1.4718

GENERAL DESCRIPTION

Solid wire for wear resistant overlays
 High resistance against corrosion, abrasion and impact deformation
 Hardness approximately 55-60HRC
 Optimal weldability
 Ferritic and martensitic structure

WELDING POSITIONS (ISO/ASME)



PA/1G



PB/2F



PC/2G



PD/4F



PE/4G



PF/3Gu

SHIELDING GASES (ACC. ISO 14175)

M21 : Mixed gas Ar+ >15-25% CO₂

CHEMICAL COMPOSITION (W%) TYPICAL WIRES

C	Mn	Cr	Si
0.5	0.4	9.0	3.0

MECHANICAL PROPERTIES, TYPICAL, ALL WELD METAL

2 Layers, AW
 heat resistant to 450°C

Typical hardness values
 : approx. 60 HRC

APPLICATION

Dies
 Matrix
 Parts for agricultural machinery
 Transport rolls
 Sand pumps

PACKAGING AND AVAILABLE SIZES

Diameter (mm)	1.0	1.2
---------------	-----	-----

15 kg spool B300	X	X
------------------	---	---

Other sizes and packaging on request

LNM 420FM; rev. C-EN24-01/02/16

LNM 4M

CLASSIFICATION

EN 14700 S Fe2 Mat-Nr 1.8405

GENERAL DESCRIPTION

Solid wire for hardfacing applications
 Hardness approximately HB 325-375
 Optimal welding characteristics
 Martensitic structure

WELDING POSITIONS (ISO/ASME)



PA/1G



PB/2F



PC/2G



PD/4F



PE/4G



PF/3Gu

SHIELDING GASES (ACC. ISO 14175)

M21 : Mixed gas Ar+ >15-25% CO₂

CHEMICAL COMPOSITION (W%) TYPICAL WIRES

C	Mn	Si	Cr
0.7	1.9	0.5	1.0

MECHANICAL PROPERTIES, TYPICAL, ALL WELD METAL

2 Layers, AW

Typical hardness values
 : approx. 38 HRC

APPLICATION

Forming dies
 Dies
 Impact resistance tools

PACKAGING AND AVAILABLE SIZES

Diameter (mm) 1.2

15 kg spool B300 X

Other sizes and packaging on request

LNM 4M: rev. C-EN24-01/02/16

TIG RODS

Mild Steel

LNT 25	358
LNT 26	359

Low Alloy Steel

LNT 28	360
LNT Ni1	361
LNT NiMo1	362
LNT Ni2.5	363
LNT 12	364
LNT 19	365
LNT 20	366
LNT 502	367
LNT 9Cr(P91)	368

Stainless Steel

LNT 304LSi	369
LNT 304L	370
LNT 347Si	371
LNT 316LSi	372
LNT 316L	373
LNT 318Si	374
LNT 4439Mn	375
LNT 4500	376
LNT 4462	377
LNT Zeron® 100X	378
LNT 309LHF	379
LNT 309LSi	380
LNT 309L	381
LNT 304H	382
LNT 310	383

Nickel alloys

LNT NiCro 60/20	384
LNT NiCro 70/19	385
LNT NiCroMo 59/23	386
LNT NiCu 70/30	387
LNT NiTi	388

Copper alloys

LNT CuNi30	389
LNT CuSn6	390
LNT CuSi3	391

Aluminium alloys

SuperGlaze® TIG 1070	392
SuperGlaze® TIG 1100	393
SuperGlaze® TIG 4043	394
SuperGlaze® TIG 4047	395
SuperGlaze® TIG 5183	396
SuperGlaze® TIG 5183	397
SuperGlaze® TIG 5356	398
SuperGlaze® TIG 5554	399
SuperGlaze® TIG 5754	400

Autogenous Wires

LNG I	401
LNG II	402
LNG IV	403

TRAINING TIPS & TRICKS

TIG WELDING ALUMINIUM



LNT 25

CLASSIFICATION

AWS A5.18	ER70S-3	A-Nr	1	Mat-Nr	1.5112
EN ISO 636-A	W 42.5 W25i	F-Nr	6		
		9606 FM	1		

GENERAL DESCRIPTION

Solid rod for welding general construction in mild steel
High impact values

SHIELDING GASES (ACC. ISO 14175)

I1 Inert gas Ar (100%)

APPROVALS

TÜV	CE
+	+

CHEMICAL COMPOSITION (W%) TYPICAL WIRE

C	Mn	Si
0.08	1.1	0.6

MECHANICAL PROPERTIES, TYPICAL, ALL WELD METAL

	Shielding gas	Condition	Yield strength (N/mm ²)	Tensile strength (N/mm ²)	Elongation (%)	Impact ISO-V(J)	
						-20°C	-50°C
Typical values	I1	AW	450	560	26	170	100

EXAMPLES OF MATERIALS TO BE WELDED

Steel grades	Standard	Type
General structural steels	EN 10025	S185, S235, S275, S355
Ship plates	ASTM A131	Grade A, B, D, AH32 to DH 36.
Cast steels	EN 10213-2	GP240R
Pipe material	EN 10208-1	L210, L240, L290, L360
	EN 10208-2	L240NB, L290NB, L360NB, L360QB, L240MB, L290MB, L360MB, L415MB, L415NB
	API 5LX	X42, X46, X52, X60
	EN 10216-1	P235T1, P235T2, P275T1
	EN 10217-1	P275T2, P355N
Boiler & pressure vessel steels	EN 10028-2	P235GH, P265GH, P295GH, P355GH
Fine grained steels	EN 10025 part 3	S275, S355, S420
	EN 10025 part 4	S275M, S275ML, S355M, S355ML, S420M, S420ML

PACKAGING AND AVAILABLE SIZES

Diameter (mm)	1.6	2.0	2.4	3.2	Note : Cut length = 1000 mm
5 kg PE-Tube	X	X	X	X	

LNT 25: rev. C-EN25-01/02/16

All information in this data sheet is accurate to the best of our knowledge at the time of printing. Please refer to www.lincolnelectric.eu for any updated information. Fumes: Safety Data Sheets (SDS) are available on our website.

LNT 26

CLASSIFICATION

AWS A5.18	ER70S-6	A-Nr	1	Mat-Nr	1.5125
EN ISO 636-A	W 42.5 W35i1	F-Nr	6		
		9606 FM	1		

GENERAL DESCRIPTION

Solid rod for welding general construction in mild steel
Smooth bead appearance

SHIELDING GASES (ACC. ISO 14175)

I1 Inert gas Ar (100%)

APPROVALS

TÜV	CE
+	+

CHEMICAL COMPOSITION (W%) TYPICAL WIRE

C	Mn	Si
0.1	1.5	0.9

MECHANICAL PROPERTIES, TYPICAL, ALL WELD METAL

	Shielding gas	Condition	Yield strength (N/mm ²)	Tensile strength (N/mm ²)	Elongation (%)	Impact ISO-V(J)		
						-20°C	-30°C	-50°C
Typical values	I1	AW	460	580	26	170	170	120

EXAMPLES OF MATERIALS TO BE WELDED

Steel grades	Standard	Type
General structural steels	EN 10025	S185, S235, S275, S355
Ship plates	ASTM A131	Grade A, B, D, AH32 to DH 36.
Cast steels	EN 10213-2	GP240R
Pipe material	EN 10208-1	L210, L240, L290, L360
	EN 10208-2	L240NB, L290NB, L360NB, L360QB, L240MB, L290MB, L360MB, L415MB, L415NB
	API 5LX	X42, X46, X52, X60
	EN 10216-1	P235T1, P235T2, P275T1
	EN 10217-1	P275T2, P355N
Boiler & pressure vessel steels	EN 10028-2	P235GH, P265GH, P295GH, P355GH
Fine grained steels	EN 10025 part 3	S275, S355, S420
	EN 10025 part 4	S275M, S275ML, S355M, S355ML, S420M, S420ML

PACKAGING AND AVAILABLE SIZES

Diameter [mm]	1.6	2.0	2.4	3.2	Note : Cut length = 1000 mm
5 kg PE-Tube	X	X	X	X	

LNT 26: rev. C-EN25-01/02/16

All information in this data sheet is accurate to the best of our knowledge at the time of printing. Please refer to www.lincolnelectric.eu for any updated information.
Fumes: Safety Data Sheets (SDS) are available on our website.

LNT 28

CLASSIFICATION

AWS A5.28	ER80S-G	A-Nr	10
		F-Nr	6
		9606 FM	2

GENERAL DESCRIPTION

Solid rod for welding of weather resisting steels
Excellent mechanical properties

SHIELDING GASES (ACC. ISO 14175)

I1 Inert gas Ar (100%)

APPROVALS

CE

+

CHEMICAL COMPOSITION (W%) TYPICAL WIRE

C	Mn	Si	Ni	Cu
0.1	1.4	0.75	0.8	0.3

MECHANICAL PROPERTIES, TYPICAL, ALL WELD METAL

	Shielding gas	Condition	Yield strength (N/mm ²)	Tensile strength (N/mm ²)	Elongation (%)	Impact ISO-V(J) -20°C
Typical values	I1	AW	570	620	26	80

EXAMPLES OF MATERIALS TO BE WELDED

Steel grades	Standard	Type
Weather resisting steels	EN 10155	S 235 J 0 W
		S 235 J 2 W
		S 355 J 0 W
		S 355 J 2 W
		S 355 K 2 G 1 W

PACKAGING AND AVAILABLE SIZES

Diameter (mm)	2.4	Note : Cut length = 1000 mm
5 kg PE-Tube	X	

LNT 28: rev. C-EN23-01/02/16

All information in this data sheet is accurate to the best of our knowledge at the time of printing. Please refer to www.lincolnelectric.eu for any updated information. Fumes: Safety Data Sheets (SDS) are available on our website.

LNT Ni1

CLASSIFICATION

AWS A5.28	ER80S-Ni1	A-Nr	12
EN ISO 636-A	W 42 6 W3Ni1	F-Nr	6
		9606 FM	1

GENERAL DESCRIPTION

Solid rod for welding fine grained and low alloy nickel steels
 High impact value at low temperature [-60°C]
 Typical offshore applications

SHIELDING GASES (ACC. ISO 14175)

II Inert gas Ar (100%)

APPROVALS

GL	TÜV	CE	DNV
+	+	+	+

CHEMICAL COMPOSITION (W%) TYPICAL WIRE

C	Mn	Si	Ni
0.1	1.2	0.6	0.9

MECHANICAL PROPERTIES, TYPICAL, ALL WELD METAL

	Shielding gas	Condition	Yield strength	Tensile strength	Elongation	Impact ISO-V(J)
			[N/mm ²]	[N/mm ²]	[%]	-60°C
Typical values	II	AW	480	580	30	60

EXAMPLES OF MATERIALS TO BE WELDED

Steel grades	Standard	Type
General structural steels	EN 10025	S275, S355
Ship plates	ASTM A131	Grade A, B, D, E, AH32 to EH36
Cast steels	EN 10213-2	GP240R
Pipe material	EN 10208-1	L290 GA, L360GA
EN 10208-2	L290, L360, L415	
API 5LX	X42, X46, X52, X60, X65	
EN 10216-1	P275T1	
EN 10217-1	P275 T2, P355 N	
Fine grained steels	EN 10025 part 3	S275, S355, S420, S460
EN 10025 part 4	S275, S355, S420, S460	
EN 10028	P355NL-1, P460NL-1	

PACKAGING AND AVAILABLE SIZES

Diameter (mm)	1.6	2.0	2.4	3.0	Note : Cut length = 1000 mm
5 kg PE-Tube	X	X	X	X	

LNT Ni1: rev. C-EN28-01/02/16

All information in this data sheet is accurate to the best of our knowledge at the time of printing. Please refer to www.lincolnelectric.eu for any updated information.
 Fumes: Safety Data Sheets (SDS) are available on our website.

LINCOLN
ELECTRIC
 THE WELDING EXPERTS®

GTAW

LNT NiMo1

CLASSIFICATION

AWS A5.28	ER1005-G	A-Nr	2
ISO 16834-A	W Mn3Ni1Mo	F-Nr	-
		9606 FM	2

GENERAL DESCRIPTION

Alloy TIG rod suitable for welding high tensile strength steels
Excellent mechanical properties

SHIELDING GASES (ACC. ISO 14175)

II Inert gas Ar (100%)

CHEMICAL COMPOSITION (W%) TYPICAL WIRE

C	Mn	Si	Ni	Mo	Ti
0.08	1.7	0.7	0.9	0.35	0.17

MECHANICAL PROPERTIES, TYPICAL, ALL WELD METAL

	Shielding gas	Condition	Yield strength (N/mm ²)	Tensile strength (N/mm ²)	Elongation (%)
Typical values	II	AW	760	800	18

EXAMPLES OF MATERIALS TO BE WELDED

Steel grades	Standard	Type
Pipe material	EN 10208-2	L480, L550
API 5LX	X65, X70, X80	
Fine grained steels	EN 10025 part 6	S460, S500, S550, S620

PACKAGING AND AVAILABLE SIZES

Diameter (mm)	2.0	2.4
5 kg PE-Tube	X	X

LNT NiMo1 : rev. C-EN03-01/02/16

All information in this data sheet is accurate to the best of our knowledge at the time of printing. Please refer to www.lincolnelectric.eu for any updated information. Fumes: Safety Data Sheets (SDS) are available on our website.

LNT Ni2.5

CLASSIFICATION

AWS A5.28	ER80S-Ni2	A-Nr	10
EN ISO 636-A	W2 Ni2	F-Nr	6
		9606 FM	1

GENERAL DESCRIPTION

Solid rod for welding fine grained and low alloy nickel steels
 High impact value at low temperature [-60°C as welded and -90°C after stress relieving 15h/580°C].
 Typical offshore applications

SHIELDING GASES (ACC. ISO 14175)

II Inert gas Ar (100%)

APPROVALS

TÜV	CE
+	+

CHEMICAL COMPOSITION (W%) TYPICAL WIRE

C	Mn	Si	Ni
0.1	1.1	0.55	2.4

MECHANICAL PROPERTIES, TYPICAL, ALL WELD METAL

	Shielding gas	Condition	Yield strength (N/mm ²)	Tensile strength (N/mm ²)	Elongation (%)	Impact ISO-V(J)	
						-62°C	-90°C
Typical values	II	AW	525	605	28	280	133

EXAMPLES OF MATERIALS TO BE WELDED

Steel grades	Standard	Type
General structural steels	EN 10025	S355
Pipe material	EN 10208-2	L360, L415, L445
API 5 LX	X52, X56, X60, X65	
Fine grained steels	EN 10025 part 3	S355, S420, S460
EN 10025 part 4	S355, S420, S460	
Low temperature steels	EN 10028-4	11 MnNi 5-3, 13 MnNi 6-3, 15 NiMn 6
	(12 Ni 14 G 1, G 2)	
EN 10222-3	13 MnNi 6-3, 15 NiMn 6	

PACKAGING AND AVAILABLE SIZES

Diameter (mm)	2.4	3.0	
5 kg PE-Tube	X	X	Note : Cut length = 1000 mm

LNT Ni2.5: rev. C-EN26-01/02/16

LNT 12

CLASSIFICATION

AWS A5.28	ER70S-A1	A-Nr	2	Mat-Nr	1.5424
ISO 21952-A	W MoSi	F-Nr	6		
		9606 FM	1/3		

GENERAL DESCRIPTION

Solid rod for welding creep resistant 0.5%Mo steels and Fine grained steels for low temperature applications in the as welded condition with service temperatures in range -20°C to +500°C

SHIELDING GASES (ACC. ISO 14175)

II Inert gas Ar (100%)

APPROVALS

TÜV	DNV	GL	DB
+	+	+	+

CHEMICAL COMPOSITION (W%) TYPICAL WIRE

C	Mn	Si	Mo
0.1	1.2	0.6	0.5

MECHANICAL PROPERTIES, TYPICAL, ALL WELD METAL

	Shielding gas	Condition	Yield strength (N/mm ²)	Tensile strength (N/mm ²)	Elongation (%)	Impact ISO-V(J)	
						+20°C	-20°C
Typical values	II	AW	635	670	22	170	110

EXAMPLES OF MATERIALS TO BE WELDED

Steel grades	Standard	Type
Elevated temperature steel	EN 10028-2	P295 G H, P355 G H, 16 Mo 2
EN 10222-2	17 Mo 3, 14 Mo 6	
Fine grained steels	EN 10025 part 3	S275, S355, S420
EN 10025 part 4	S275, S355, S420	

APPLICATION ADVICE

Preheating welding joint acc.EN 1011-1
Stress relieving 580-650°C if necessary

PACKAGING AND AVAILABLE SIZES

Diameter (mm)	1.6	2.0	2.4	3.0	<i>Note: Cut length = 1000 mm</i>
5 kg PE-Tube	X	X	X	X	

LNT 12: rev. C-EN25-01/02/16

All information in this data sheet is accurate to the best of our knowledge at the time of printing. Please refer to www.lincolnelectric.eu for any updated information. Fumes: Safety Data Sheets (SDS) are available on our website.

LNT 19

CLASSIFICATION

AWS A5.28	ER80S-B2*	A-Nr	3	Mat-Nr	1.7339
ISO 21952-A	W CrMo1Si	F-Nr	6		
* Nearest classification		9606 FM	3		

GENERAL DESCRIPTION

Solid rod for welding creep and hydrogen resistant Cr-Mo steels (1,25Cr - 0,5Mo)
Service temperature up to 550°C

SHIELDING GASES (ACC. ISO 14175)

11 Inert gas Ar (100%)

APPROVALS

TÜV

+

CHEMICAL COMPOSITION (W%) TYPICAL WIRE

C	Mn	Si	Cr	Mo
0.1	1.0	0.6	1.2	0.5

MECHANICAL PROPERTIES, TYPICAL, ALL WELD METAL

	Shielding gas	Condition	Yield strength [N/mm ²]	Tensile strength [N/mm ²]	Elongation [%]	Impact ISO-V(J) +20°C
Typical values	11	PWHT 700°C/1h	540	640	22	250

EXAMPLES OF MATERIALS TO BE WELDED

Steel grades	Standard	Type
Elevated temperature steel	EN 10028-2	13 CrMo4-5
EN 10083-1	25 CrMo 4	
EN 10222-2	14 CrMo 4-5	
Tool steel	DIN 17210	16 MnCr 5

PACKAGING AND AVAILABLE SIZES

Diameter [mm]	2.0	2.4	3.0	
5 kg PE-Tube	X	X	X	Note : Cut length = 1000 mm

LNT 19: rev. C-EN26-01/02/16

All information in this data sheet is accurate to the best of our knowledge at the time of printing. Please refer to www.lincolnelectric.eu for any updated information.
Fumes: Safety Data Sheets (SDS) are available on our website.

LINCOLN
ELECTRIC
THE WELDING EXPERTS®

LNT 20

CLASSIFICATION

AWS A5.28	ER90S-B3*	A-Nr	4	Mat-Nr	1.7384
ISO 21952-A	W CrMo2Si	F-Nr	6		
* Nearest classification		9606 FM	4		

GENERAL DESCRIPTION

Solid rod for welding creep and hydrogen resistant Cr-Mo steels [2,25Cr - 1Mo]

Service temperature up to 600°C

SHIELDING GASES (ACC. ISO 14175)

It Inert gas Ar (100%)

CHEMICAL COMPOSITION (W%) TYPICAL WIRE

C	Mn	Si	Cr	Mo
0.08	1.0	0.6	2.5	1.0

MECHANICAL PROPERTIES, TYPICAL, ALL WELD METAL

	Shielding gas	Condition	Yield strength (N/mm ²)	Tensile strength (N/mm ²)	Elongation (%)	Impact ISO-V(J) +20°C
Typical values	It	PWHT 700°C/1h	560	640	22	140

EXAMPLES OF MATERIALS TO BE WELDED

Steel grades	Standard	Type
Creep and hydrogen resistant steels	EN 10028-2	10CrMo 9-10
EN 10222-2	12CrMo 9-10	

APPLICATION ADVICE

Preheating welding joint acc. EN 1011-1, 200-250°C

Post weld heat treatment at 690-740°C

PACKAGING AND AVAILABLE SIZES

Diameter (mm)	2.0	2.4	
5 kg PE-Tube	X	X	Note : Cut length = 1000 mm

LNT20: rev. C-EN26-01/02/16

All information in this data sheet is accurate to the best of our knowledge at the time of printing. Please refer to www.lincolnelectric.eu for any updated information. Fumes: Safety Data Sheets (SDS) are available on our website.

LNT 502

CLASSIFICATION

AWS A5.28	ER80S-B6	A-Nr	4	Mat-Nr	1.7373
ISO 21952-A	W CrMo5Si*	F-Nr	6		
* Nearest classification		9606 FM	4		

GENERAL DESCRIPTION

Solid rod for welding of creep and hydrogen resistant 5%Cr, 0.5%Mo steels
Service temperature up to 550°C

SHIELDING GASES (ACC. ISO 14175)

I1 Inert gas Ar (100%)

CHEMICAL COMPOSITION (W%) TYPICAL WIRE

C	Mn	Si	Cr	Mo
0.09	0.6	0.3	5.7	0.6

MECHANICAL PROPERTIES, TYPICAL, ALL WELD METAL

	Shielding gas	Condition	Yield strength (N/mm ²)	Tensile strength (N/mm ²)	Elongation (%)	Impact ISO-V(J) +20°C
Typical values	I1	PWHT 750°C/1h	560	650	20	80

EXAMPLES OF MATERIALS TO BE WELDED

Steel grades	Standard	Type
Creep and hydrogen resistant steels	SEW 028	12CrMo 19-5 and corresponding steels
ASTM A182	F5	
ASTM A213	T5	
ASTM A335	P5	
ASTM A336	F5	
ASTM A369	FP5	
ASTM A387	Grade 5	

APPLICATION ADVICE

Recommended preheat and interpass temperature 200-300°C
Recommended post weld heat treatment at range 675-750°C (time depending on material thickness)

PACKAGING AND AVAILABLE SIZES

Diameter (mm)	2.4	<i>Note : Cut length = 1000 mm</i>
5 kg PE-Tube	X	

LNT 502 rev. C-EN26-01/02/16

LNT 9Cr(P91)

CLASSIFICATION

AWS A5.28	ER90S-B39	A-Nr	5
ISO 21952-A	W CrMo91	F-Nr	6
		9606 FM	4

GENERAL DESCRIPTION

Solid rod for welding of creep and hydrogen resistant 9% Cr, 1% Mo steels
Service temperature up to 650°C

SHIELDING GASES (ACC. ISO 14175)

I1 Inert gas Ar (100%)

CHEMICAL COMPOSITION (W%) TYPICAL WIRE

C	Mn	Si	Cr	Mo	Ni	Nb	V	Cu
0.11	0.8	0.25	8.9	1.0	0.5	0.06	0.2	0.06

MECHANICAL PROPERTIES, TYPICAL, ALL WELD METAL

	Shielding gas	Condition	Yield strength (N/mm ²)	Tensile strength (N/mm ²)	Elongation (%)	Impact ISO-V(J) -20°C
Typical values	I1	SR 750°C/3h	500	700	18	70

EXAMPLES OF MATERIALS TO BE WELDED

Steel grades	Standard	Type	Standard	Type
Creep and hydrogen resistant steels	EN 10222-2	X10CrMo V9-1 steels		
	ASTM	A199 Grade T91	ASME	SA 182-F91
		A200 Grade T91		
		A213 Grade T91		SA 213-T91
		A335 Grade P91		SA 335-P91
		A336 Grade F91		SA 336-F91
				SA 369-FP91
				SA 387-Grade 91
			SA 387-Grade 91	

PACKAGING AND AVAILABLE SIZES

Diameter (mm)	2.0	2.4	
5 kg PE-Tube	X	X	<i>Note : Cut length = 1000 mm</i>

LNT 9Cr(P91); rev. C-EN26-12/05/16

All information in this data sheet is accurate to the best of our knowledge at the time of printing. Please refer to www.lincolnelectric.eu for any updated information. Fumes: Safety Data Sheets (SDS) are available on our website.

LNT 304LSi

CLASSIFICATION

AWS A5.9	ER308LSi	A-Nr	8	Mat-Nr	1.4316
ISO 14343-A	W 19 9 L Si	F-Nr	6		
		9606 FM	5		

GENERAL DESCRIPTION

Solid rod with extra low carbon for welding austenitic CrNi-steels
With increased silicon for improved wettability

SHIELDING GASES (ACC. ISO 14175)

II Inert gas Ar (100%)

APPROVALS

DNV	TÜV	CE	DB
+	+	+	+

CHEMICAL COMPOSITION (W%) TYPICAL WIRE

C	Mn	Si	Cr	Ni	Mo
0.02	2.0	0.8	20	10	0.1

MECHANICAL PROPERTIES, TYPICAL, ALL WELD METAL

	Shielding gas	Condition	0.2% proof strength (N/mm ²)	Tensile strength (N/mm ²)	Elongation (%)	Impact ISO-V(J)	
						+20°C	-196°C
Typical values	II	AW	467	622	37	147	67

EXAMPLES OF MATERIALS TO BE WELDED

Steel grades	EN 10088-1/-2	EN 10213-4	Mat. Nr	ASTM/ACI A240/A312/A351	UNS
Extra low carbon [C < 0.03%]					
	X2CrNi19-11		1.4306	(TP)304 L	S30403
				CF-3	J92500
	X2CrNi18-10		1.4311	(TP)304LN	S30453
				302, 304	S30400
Medium carbon [C > 0.03%]					
	X4CrNi18-10		1.4301	(TP)304	S30409
		G-X5CrNi19-10	1.4308	CF-8	J92600
Ti-,Nb stabilized					
	X6CrNiTi18-10		1.4541	(TP)321	S32100
				(TP)321H	S32109
	X6 CrNiNb18-10		1.4550	(TP)347	S34700
		G-X5CrNiNb19-10	1.4552	CF-8C	J92710

PACKAGING AND AVAILABLE SIZES

Diameter (mm)	1.0	1.2	1.6	2.0	2.4	3.2	Note : Cut length = 1000 mm
5 kg PE-Tube	X	X	X	X	X	X	

LNT 304LSi rev. C-EN23-01/02/16

All information in this data sheet is accurate to the best of our knowledge at the time of printing. Please refer to www.lincolnelectric.eu for any updated information. Fumes: Safety Data Sheets (SDS) are available on our website.

LINCOLN
ELECTRIC
THE WELDING EXPERTS®

LNT 304L

CLASSIFICATION

AWS A5.9	ER308L	A-Nr	8	Mat-Nr	1.4316
ISO 14343-A	W 19 9 L	F-Nr	6		
		9606 FM	5		

GENERAL DESCRIPTION

Solid rod with extra low carbon for welding austenitic CrNi-steels
High resistance to intergranular corrosion and oxidizing environments

SHIELDING GASES (ACC. ISO 14175)

l1 Inert gas Ar (100%)

APPROVALS

CE

+

CHEMICAL COMPOSITION (W%) TYPICAL WIRE

C	Mn	Si	Cr	Ni	Mo
0.01	1.7	0.4	20	10	0.1

MECHANICAL PROPERTIES, TYPICAL, ALL WELD METAL

Typical values	Shielding gas	Condition	0.2% proof strength [N/mm ²]	Tensile strength [N/mm ²]	Elongation [%]	Impact ISO-V[J]	
						+20°C	-196°C
	l1	AW	472	692	34	120	91

EXAMPLES OF MATERIALS TO BE WELDED

Steel grades	EN 10088-1/-2	EN 10213-4	Mat. Nr	ASTM/ACI A240/A312/A351	UNS
Extra low carbon [C < 0.03%]					
	X2CrNi19-11		1.4306	(TP)304 L	S30403
	X2CrNi18-10		1.4311	CF-3 (TP)304LN 302, 304	J92500 S30453 S30400
Medium carbon [C > 0.03%]					
	X4CrNi18-10	G-X5CrNi19-10	1.4301 1.4308	(TP)304 CF-8	S30409 J92600
Ti-,Nb stabilized					
	X6CrNiTi18-10		1.4541	(TP)321 (TP)321H	S32100 S32109
	X6CrNiNb18-10	G-X5CrNiNb19-10	1.4550 1.4552	(TP)347 CF-8C	S34700 J92710

PACKAGING AND AVAILABLE SIZES

Diameter (mm)	1.2	1.6	2.0	2.4	3.2	Note : Cut length = 1000 mm
5 kg PE-Tube	X	X	X	X	X	

LNT 304L: rev. C-EN24-01/02/16

All information in this data sheet is accurate to the best of our knowledge at the time of printing. Please refer to www.lincolnelectric.eu for any updated information.
Fumes: Safety Data Sheets (SDS) are available on our website.

LNT 347Si

CLASSIFICATION

AWS A5.9	ER347Si	A-Nr	8	Mat-Nr	1.4551
ISO 14343-A	W 19 9 NbSi	F-Nr	6		
		9606 FM	5		

GENERAL DESCRIPTION

Solid rod for welding Ti or Nb stabilized stainless CrNi-steels
High resistance to intergranular corrosion and oxidizing environments

SHIELDING GASES (ACC. ISO 14175)

It Inert gas Ar (100%)

APPROVALS

TÜV	CE	DB
+	+	+

CHEMICAL COMPOSITION (W%) TYPICAL WIRE

C	Mn	Si	Cr	Ni	Mo	Nb
0.05	1.4	0.7	19.5	9.5	0.01	0.6

MECHANICAL PROPERTIES, TYPICAL, ALL WELD METAL

	Shielding gas	Condition	0.2% proof strength	Tensile strength	Elongation	Impact ISO-V(J)	
			[N/mm ²]	[N/mm ²]	[%]	+20°C	-196°C
Typical values	It	AW	400	650	35	80	45

EXAMPLES OF MATERIALS TO BE WELDED

Steel grades	EN 10088-1/-2	EN 10213-4	Mat. Nr	ASTM/ACI A240/A312/A351	UNS
Ti-,Nb stabilized					
	X6CrNiTi18-10		1.4541	(TP)321 (TP)321H	S32100 S32109
	X6CrNiNb18-10		1.4550	(TP)347 (TP)347h	S34700 S34709
		G-X5CrNiNb19-10	1.4552	CF-8C	J92710
Non stabilized					
	X4CrNi18-10		1.4301	302 (TP)304	S30400
	X2CrNi19-11		1.4306	(TP)304L	S30403
		G-X5CrNi19-10	1.4308 1.4312	CF-8 (TP)304H	J92600 S30409

PACKAGING AND AVAILABLE SIZES

Diameter (mm)	1.6	2.0	2.4	3.2	Note : Cut length = 1000 mm
5 kg PE-Tube	X	X	X	X	

LNT 347Si : rev. C-EN24-01/02/16

All information in this data sheet is accurate to the best of our knowledge at the time of printing. Please refer to www.lincolnelectric.eu for any updated information.
Fumes: Safety Data Sheets (SDS) are available on our website.

LNT 316LSi

CLASSIFICATION

AWS A5.9	ER316LSi	A-Nr	8	Mat-Nr	1.4430
ISO 14343-A	W 19 12 3 LSi	F-Nr	6		
		9606 FM	5		

GENERAL DESCRIPTION

Solid rod with extra low carbon for welding stainless CrNiMo-steels
See also LNT 316L, high silicon for improved wettability

SHIELDING GASES (ACC. ISO 14175)

It Inert gas Ar (100%)

APPROVALS

DNV	TÜV	DB	CE	ABS
+	+	+	+	+

CHEMICAL COMPOSITION (W%) TYPICAL WIRE

C	Mn	Si	Cr	Ni	Mo
0.03	1.9	0.8	18.5	12.0	2.7

MECHANICAL PROPERTIES, TYPICAL, ALL WELD METAL

	Shielding gas	Condition	0.2% proof strength [N/mm ²]	Tensile strength [N/mm ²]	Elongation [%]	Impact ISO-V(J)	
						+20°C	-196°C
Typical values	It	AW	484	624	32	100	82

EXAMPLES OF MATERIALS TO BE WELDED

Steel grades	EN 10088-1/-2	EN 10213-4	Mat. Nr	ASTM/ACI A240/A312/A351	UNS
Extra low carbon [C < 0.03%]					
	X2CrNiMo1712-2		1.4404	(TP)316L	S31603
	X2CrNiMo18-14-3		1.4435	CF-3M	J92800
	X2CrNiMoN17-11-2		1.4406	(TP)316L	S31603
	X2CrNiMoN17-13-3		1.4429	(TP)316LN	S31653
Medium carbon [C > 0.03%]					
	X4CrNiMo17-12-2		1.4401	(TP)316	S31600
	X4CrNiMo17-13-3		1.4436		
		G-X5CrNiMo19-11	1.4408	CF 8M	J92900
Ti-,Nb stabilized					
	X6CrNiMoTi17-12-2		1.4571	316 Ti	S31635
	X6CrNiMoNb17-12-2		1.4580	316 Cb	S31640
	X6CrNiNb18-10		1.4550	(TP)347	S34700
		G-X5CrNiNb19-10	1.4552	CF-8C	J92710

PACKAGING AND AVAILABLE SIZES

Diameter (mm)	1.0	1.2	1.6	2.0	2.4	3.2	Note : Cut length = 1000 mm
5 kg PE-Tube	X	X	X	X	X	X	

LNT 316LSi: rev. C-EN24-01/02/16

All information in this data sheet is accurate to the best of our knowledge at the time of printing. Please refer to www.lincolnelectric.eu for any updated information. Fumes: Safety Data Sheets (SDS) are available on our website.

LNT 316L

CLASSIFICATION

AWS A5.9	ER316L	A-Nr	8	Mat-Nr	1.4430
ISO 14343-A	W 19 12 3 L	F-Nr	6		
		9606 FM	5		

GENERAL DESCRIPTION

Solid rod with extra low carbon for welding austenitic CrNiMo-steels
High resistance to intergranular corrosion and general corrosion conditions

SHIELDING GASES (ACC. ISO 14175)

I1 Inert gas Ar (100%)

CHEMICAL COMPOSITION (W%) TYPICAL WIRE

C	Mn	Si	Cr	Ni	Mo
0.01	1.5	0.5	18.5	12	2.7

MECHANICAL PROPERTIES, TYPICAL, ALL WELD METAL

Typical values	Shielding gas	Condition	0.2% proof	Tensile strength	Elongation	Impact ISO-V(J)		
			strength (N/mm ²)	(N/mm ²)	(%)	+20°C	-120°C	-196°C
	I1	AW	400	620	35	100	80	40

EXAMPLES OF MATERIALS TO BE WELDED

Steel grades	EN 10088-1/-2	EN 10213-4	Mat. Nr	ASTM/ACI A240/A312/A351	UNS
Extra low carbon [C < 0.03%]					
	X2CrNiMo17-12-2		1.4404	(TP)316L	S31603
	X2CrNiMo18-14-3		1.4435	CF-3M	J92800
	X2CrNiMoN17-11-2		1.4406	(TP)316LN	S31653
	X2CrNiMoN17-13-3		1.4429		
Medium carbon [C > 0.03%]					
	X4CrNiMo17-12-2		1.4401	(TP)316	S31600
	X4CrNiMo17-13-3		1.4436		
		G-X5CrNiMo19-11	1.4408	CF 8M	J92900
Ti-,Nb stabilized					
	X6CrNiMoTi17-12-2		1.4571	316 Ti	S31635
	X6CrNiMoNb17-12-2		1.4580	316Cb	S31640
	X6CrNiNb18-10		1.4550	(TP)347	S34700
		G-X5CrNiNb19-10	1.4552	CF-8C	J92710

PACKAGING AND AVAILABLE SIZES

Diameter (mm)	1.6	2.0	2.4	3.2
5 kg PE-Tube	X	X	X	X

LNT 316L: rev. C-EN25-01/02/16

All information in this data sheet is accurate to the best of our knowledge at the time of printing. Please refer to www.lincolnelectric.eu for any updated information. Fumes: Safety Data Sheets (SDS) are available on our website.

LINCOLN
ELECTRIC
THE WELDING EXPERTS®

LNT 318Si

CLASSIFICATION

AWS A5.9	ER318*	A-Nr	8	Mat-Nr	1.4576
ISO 14343-A	W 19 12 3 NbSi	F-Nr	6		
* Nearest classification		9606 FM	5		

GENERAL DESCRIPTION

Solid rod for welding Ti or Nb stabilized stainless CrNiMo-steels
High resistance to intergranular corrosion and general corrosion conditions

SHIELDING GASES (ACC. ISO 14175)

I1 Inert gas Ar (100%)

CHEMICAL COMPOSITION (W%) TYPICAL WIRE

C	Mn	Si	Cr	Ni	Mo	Nb
0.05	1.4	0.7	18.7	11.7	2.5	0.7

MECHANICAL PROPERTIES, TYPICAL, ALL WELD METAL

Typical values	Shielding gas	Condition	0.2% proof strength [N/mm ²]	Tensile strength [N/mm ²]	Elongation [%]	Impact ISO-V(J)	
						+20°C	-196°C
	I1	AW	420	680	35	70	45

EXAMPLES OF MATERIALS TO BE WELDED

Steel grades	EN 10088-1/-2	EN 10213-4	Mat. Nr	ASTM/ACI A240/A312/A351	UNS
Extra low carbon [C < 0.03%]					
	X2CrNiMo17-12-2		1.4404	(TP)316L	S31603
	X2CrNiMo18-14-3		1.4435	CF-3M	J92800
	X2CrNiMoN17-11-2		1.4406	(TP)316L	S31603
	X2CrNiMoN17-13-3		1.4429	(TP)316LN	S31653
Medium carbon [C > 0.03%]					
	X4CrNiMo17-12-2		1.4401	(TP)316	S31600
	X4CrNiMo17-13-3		1.4436		
		G-X5CrNiMo19-11	1.4408	CF 8M	J92900
Ti-,Nb stabilized					
	X6CrNiMoTi17-12-2		1.4571	316 Ti	S31635
	X6CrNiMoNb17-12-2		1.4580	316 Cb	S31640
	X6CrNiNb18-10		1.4550	(TP)347	S34700
		G-X5CrNiNb19-10	1.4552	CF-8C	J92710

PACKAGING AND AVAILABLE SIZES

Diameter (mm)	1.6	2.0	2.4	3.2
5 kg PE-Tube	X	X	X	X

LNT 318Si rev. C-EN24-01/02/16

All information in this data sheet is accurate to the best of our knowledge at the time of printing. Please refer to www.lincolnelectric.eu for any updated information. Fumes: Safety Data Sheets (SDS) are available on our website.

LNT 4439Mn

CLASSIFICATION

ISO 14343-A	W 18 16 5 N L*	A-Nr	9*	Mat-Nr	1.4453
		F-Nr	-		
	* Nearest classification	9606 FM	5		

GENERAL DESCRIPTION

Solid rod for welding AISI 317L, 317LN or equivalent stainless steels
 For welding 316L if increased molybdenum content is important
 High resistance to pitting, intergranular and stress corrosion
 Fully austenitic weld metal

SHIELDING GASES (ACC. ISO 14175)

II Inert gas Ar (100%)

CHEMICAL COMPOSITION (W%) TYPICAL WIRE

C	Mn	Si	Cr	Ni	Mo	N
0.02	7	0.4	18	16	4.5	0.15

MECHANICAL PROPERTIES, TYPICAL, ALL WELD METAL

	Shielding gas	Condition	0.2% proof strength [N/mm ²]	Tensile strength [N/mm ²]	Elongation [%]	Impact ISO-V(J) -196°C
Typical values	II	AW	440	650	35	80

EXAMPLES OF MATERIALS TO BE WELDED

Steel grades	EN 10088-1/-2	EN 10213-4	Mat. Nr	ASTM/ACI	UNS
Fully austenitic CrNiMo corrosion resistant steels					
	X2CrNiMoN17-11-2		1.4406	[TP]316LN	S31653
	X2CrNiMoN17-13-3		1.4429	[TP]316LN	S31653
	X2CrNiMo18-14-3		1.4435	[TP]316L	S31603
	X2CrNiMo18-15-4		1.4438	317L	S31725
	X2CrNiMoN17-13-5		1.4439	317LN	S31726
	G-X2CrNiMoN17-13-4	G-X2CrNiMo17-13-4	1.4446		
	G-X6CrNiMo17-13	G-X6CrNiMo17-13	1.4448		

PACKAGING AND AVAILABLE SIZES

Diameter [mm]	2.0	2.4
5 kg PE-Tube	X	X

LNT 4439Mn, rev. C-EN23-01/02/16

All information in this data sheet is accurate to the best of our knowledge at the time of printing. Please refer to www.lincolnelectric.eu for any updated information. Fumes: Safety Data Sheets (SDS) are available on our website.

LINCOLN
ELECTRIC
 THE WELDING EXPERTS®

GTAW

LNT 4500

CLASSIFICATION

AWS A5.9	ER385	A-Nr	9
ISO 14343-A	W 20 25 5 Cu L	F-Nr	6
		9606 FM	5

GENERAL DESCRIPTION

Solid rod for welding of fully austenitic steels of type 20%Cr / 25%Ni / 4.5%Mo / 1.5%Cu
Highly corrosion resistant in sulphuric and phosphoric acid

SHIELDING GASES (ACC. ISO 14175)

I1 Inert gas Ar (100%)

APPROVALS

TÜV

+

CHEMICAL COMPOSITION (W%) TYPICAL WIRE

C	Mn	Si	Cr	Ni	Mo	Cu
0.01	1.7	0.4	20	25	4.5	1.5

MECHANICAL PROPERTIES, TYPICAL, ALL WELD METAL

	Shielding gas	Condition	0.2% proof strength (N/mm ²)	Tensile strength (N/mm ²)	Elongation (%)	Impact ISO-V(J) -196°C
Typical values	I1	AW	380	560	35	80

EXAMPLES OF MATERIALS TO BE WELDED

Steel grades	EN 10088-1/-2	EN 10213-4	Mat. Nr
Fully austenitic NiCrMoCu and CrNiMoCu steels			
	X5NiCrMoCuTi20-18	G-X7NiCrMoCuNb25-20	1.4500
		G-X2NiCrMoCuN20-18	1.4506
		G-X2NiCrMoCuN25-20	1.4531
	X1NiCrMoCuN25-20-5	G-X2NiCrMoCuN25-20	1.4536
			1.4539
		G-X7CrNiMoCuNb18-18	1.4585
	X5NiCrMoCuNb22-18		1.4586

PACKAGING AND AVAILABLE SIZES

Diameter (mm)	2.0	2.4
5 kg PE-Tube	X	X

LNT 4500: rev. C-EN24-01/02/16

LNT 4462

CLASSIFICATION

AWS A5.9	ER2209	A-Nr	8	Mat-Nr	1.4462
ISO 14343-A	W 22 9 3 N L	F-Nr	6		
		9606 FM	5		

GENERAL DESCRIPTION

Solid rod for welding duplex stainless steels
High resistance to general corrosion, pitting and stress corrosion conditions

SHIELDING GASES (ACC. ISO 14175)

I1 Inert gas Ar (100%)

APPROVALS

TÜV

+

CHEMICAL COMPOSITION (W%) TYPICAL WIRE

C	Mn	Si	Cr	Ni	Mo	N
0.01	1.6	0.5	22.5	8.5	3.0	0.15

MECHANICAL PROPERTIES, TYPICAL, ALL WELD METAL

	Shielding gas	Condition	0.2% proof strength (N/mm ²)	Tensile strength (N/mm ²)	Elongation (%)	Impact ISO-V(J) -60°C
Typical values	I1	AW	675	829	27	200

EXAMPLES OF MATERIALS TO BE WELDED

Steel grades	EN 10088-1/-2	Mat. Nr	UNS
Duplex stainless steels			
	X2CrNiMoN22-5-3	1.4462	S31803
		1.4417	S31500
	X2CrNiN23-4	1.4362	S32304
	X3CrNiMoN27-5-2	1.4460	S31200
	X2CrNiMoN21-5-1	1.4162	S32101

Dissimilar joints such as un- and low alloy steel to duplex stainless steel

PACKAGING AND AVAILABLE SIZES

Diameter (mm)	1.6	2.0	2.4	3.2	Note : Cut length = 1000 mm
5 kg PE-Tube	X	X	X	X	

LNT 4462: rev. C-EN24-01/02/16

All information in this data sheet is accurate to the best of our knowledge at the time of printing. Please refer to www.lincolnelectric.eu for any updated information. Fumes: Safety Data Sheets (SDS) are available on our website.

LINCOLN
ELECTRIC
THE WELDING EXPERTS®

LNT Zeron® 100X

CLASSIFICATION

AWS A5.9	ER2594	A-Nr	8
ISO 14343-A	W 25 9 4 N L	F-Nr	6
		9606 FM	5

GENERAL DESCRIPTION

Solid rod for welding Zeron® 100 and other super duplex stainless steel grades
High resistance to pitting and crevice corrosion in seawater

SHIELDING GASES (ACC. ISO 14175)

I1 Inert gas Ar (100%)

APPROVALS

TÜV

+

CHEMICAL COMPOSITION (W%) TYPICAL WIRE

C	Mn	Si	Cr	Ni	Mo	Cu	W	N
0.02	0.6	0.23	25	9.3	3.6	0.6	0.6	0.22

MECHANICAL PROPERTIES, TYPICAL, ALL WELD METAL

	Shielding gas	Condition	0.2% proof strength (N/mm ²)	Tensile strength (N/mm ²)	Elongation (%)	Impact ISO-V(J) -50°C
Typical values	I1	AW	655	934	42	100

EXAMPLES OF MATERIALS TO BE WELDED

Steel grades	EN 10088-1/-2	Mat. Nr	UNS		
Regular and super duplex stainless steels					
	X2CrNiMoN25-7-4		1.4410		
	X4CrNiMoN27-5-2		1.4460		
	X2CrNiMoN22-5-3		1.4462	2205	S31803
		GX6 CrNiMo 24-8-2	1.4463		
				CD-4MCu	S32550
				Zeron® 100	S32760

Super duplex stainless Steel grades: chemical composition approximately:
24-27% Cr, 6-9% Ni, 3-4% Mo, 0.10-0.25% N alloyed also with Cu and/or W

PACKAGING AND AVAILABLE SIZES

Diameter (mm)	1.6	2.0	2.4	3.2	Note : Cut length = 1000 mm
5 kg PE-Tube	X	X	X	X	

LNT Zeron® 100X: rev. C-EN25-01/02/16

LNT 309LHF

CLASSIFICATION

AWS A5.9	ER309L	A-Nr	8	Mat-Nr	1.4332
ISO 14343-A	W 23 12 L	F-Nr	6		
		9606 FM	5		

GENERAL DESCRIPTION

Solid rod for welding stainless steel to carbon steel
 Low susceptibility to embrittlement
 Minimum 18FN ferrite in weldmetal

SHIELDING GASES (ACC. ISO 14175)

I1 Inert gas Ar (100%)

CHEMICAL COMPOSITION (W%) TYPICAL WIRE

C	Mn	Si	Cr	Ni	Mo
0.02	2.0	0.35	24	13	0.1

MECHANICAL PROPERTIES, TYPICAL, ALL WELD METAL

	Shielding gas	Condition	0.2% proof strength(N/mm ²)	Tensile strength (N/mm ²)	Elongation (%)	Impact ISO-V(J)	
						+20°C	+40°C
Typical values	I1	AW	488	608	33	167	171

EXAMPLES OF MATERIALS TO BE WELDED

Steel grades	EN 10088-1/-2	Mat. Nr	ASTM/ACI A240/A312/A351	UNS
Corrosion resistant cladsteels				
	X2CrNiN18-10	1.4311	(TP)304LN	S30453
	X2CrNi19-11	1.4306	(TP)304L	S30403
			CF-3	J92500
	X4CrNi18-10	1.4301	(TP)304	S30400

Dissimilar metals (mild and low alloy steel to stainless steel)
 Build-up welding on mild and low alloy steel

PACKAGING AND AVAILABLE SIZES

Diameter (mm)	1.6	2.0
5 kg PE-Tube	X	X

LNT 309LHF Rev. C-EN25-01/02/16

All information in this data sheet is accurate to the best of our knowledge at the time of printing. Please refer to www.lincolnelectric.eu for any updated information.
 Fumes: Safety Data Sheets (SDS) are available on our website.

LINCOLN
ELECTRIC
 THE WELDING EXPERTS®

LNT 309LSi

CLASSIFICATION

AWS A5.9	ER309LSi	A-Nr	8	Mat-Nr	1.4332
ISO 14343-A	W 23 12 LSi	F-Nr	6		
		9606 FM	5		

GENERAL DESCRIPTION

Solid rod for welding stainless steel to carbon steel
With high silicon for improved wettability

SHIELDING GASES (ACC. ISO 14175)

I1 Inert gas Ar (100%)

APPROVALS

TÜV	CE
+	+

CHEMICAL COMPOSITION (W%) TYPICAL WIRE

C	Mn	Si	Cr	Ni	Mo
0.02	2.0	0.8	23.5	13	0.1

MECHANICAL PROPERTIES, TYPICAL, ALL WELD METAL

	Shielding gas	Condition	0.2% proof strength (N/mm ²)	Tensile strength (N/mm ²)	Elongation (%)	Impact ISO-V(J) -120°C
Typical values	I1	AW	400	600	35	65

EXAMPLES OF MATERIALS TO BE WELDED

Steel grades	EN 10088-1/-2	Mat. Nr	ASTM/ACI	UNS
Corrosion resistant cladsteels				
	X2CrNi18-10	1.4311	(TP)304LN	S30453
	X2CrNi19-11	1.4306	(TP)304L CF-3	S30403 J92500
	X4CrNi18-10	1.4301	(TP)304	S30400

Dissimilar metals (mild and low alloy steel to stainless steel)

Build-up welding on mild and low alloy steel

PACKAGING AND AVAILABLE SIZES

Diameter (mm)	1.6	2.0	2.4	3.2	
5 kg PE-Tube	X	X	X	X	<i>Note : Cut length = 1000 mm</i>

LNT 309LSi rev. C-EN24-01/02/16

All information in this data sheet is accurate to the best of our knowledge at the time of printing. Please refer to www.lincolnelectric.eu for any updated information. Fumes: Safety Data Sheets (SDS) are available on our website.

LNT 309L

CLASSIFICATION

AWS A5.9	ER309L	A-Nr	8	Mat-Nr	1.4332
ISO 14343-A	W 23 12 L	F-Nr	6		
		9606 FM	5		

GENERAL DESCRIPTION

Solid rod for welding stainless steel to carbon steel

SHIELDING GASES (ACC. ISO 14175)

I1 Inert gas Ar (100%)

APPROVALS

CE

+

CHEMICAL COMPOSITION (W%) TYPICAL WIRE

C	Mn	Si	Cr	Ni	Mo
0.01	1.65	0.5	24	13	0.1

MECHANICAL PROPERTIES, TYPICAL, ALL WELD METAL

	Shielding gas	Condition	0.2% proof strength (N/mm ²)	Tensile strength (N/mm ²)	Elongation (%)
Typical values	I1	AW	390	600	35

EXAMPLES OF MATERIALS TO BE WELDED

Steel grades	EN 10088-1/-2	Mat. Nr	ASTM/ACI	UNS
Corrosion resistant cladsteels				
	X2CrNiN18-10	1.4311	(TP)304LN	S30453
	X2CrNi19-11	1.4306	(TP)304L	S30403
		CF-3	J92500	
	X4CrNi18-10	1.4301	(TP)304	S30400

Dissimilar metals (mild and low alloy steel to stainless steel)

Build-up welding on mild and low alloy steel

PACKAGING AND AVAILABLE SIZES

Diameter (mm)	1.6	2.0	2.4
5 kg PE-Tube	X	X	X

LNT 309L: rev. C-EN04-01/02/16

All information in this data sheet is accurate to the best of our knowledge at the time of printing. Please refer to www.lincolnelectric.eu for any updated information. Fumes: Safety Data Sheets (SDS) are available on our website.

LINCOLN
ELECTRIC
THE WELDING EXPERTS®

LNT 304H

CLASSIFICATION

AWS A5.9	ER308H	A-Nr	8	Mat-Nr	1.4948
ISO 14343-A	W 19 9 H	F-Nr	6		
		9606 FM	5		

GENERAL DESCRIPTION

Solid rod for welding austenitic CrNi-steels
Especially for high temperature applications (up to 730°C)
Low sensitivity to precipitation of intermetallic phases

SHIELDING GASES (ACC. ISO 14175)

11 Inert gas Ar (100%)

CHEMICAL COMPOSITION (W%) TYPICAL WIRE

C	Mn	Si	Cr	Ni	Mo
0.07	1.9	0.4	20	9.2	0.1

MECHANICAL PROPERTIES, TYPICAL, ALL WELD METAL

	Shielding gas	Condition	0.2% proof strength (N/mm ²)	Tensile strength (N/mm ²)	Elongation [%]	Impact ISO-V(J) +20°C
Typical values	11	AW	370	600	35	80

EXAMPLES OF MATERIALS TO BE WELDED

Steel grades	EN 10088-1/-2	EN 10213-4	Mat. Nr	ASTM/AISI	UNS
Medium carbon (C > 0.03%)	X4CrNi18-10		1.4301	(TP)304 (TP)304H	302 S30400 S30409
		G-X5CrNi19-10	1.4308 1.4948	CF 8	J92600

PACKAGING AND AVAILABLE SIZES

Diameter (mm)	2.0	2.4
5 kg PE-Tube	X	X

LNT 304H rev. C-EN23-01/02/16

All information in this data sheet is accurate to the best of our knowledge at the time of printing. Please refer to www.lincolnelectric.eu for any updated information. Fumes: Safety Data Sheets (SDS) are available on our website.

LNT 310

CLASSIFICATION

AWS A5.9	ER310	A-Nr	9	Mat-Nr	1.4812
ISO 14343-A	W 25 20	F-Nr	6		
		9606 FM	5		

GENERAL DESCRIPTION

Solid rod for welding heat resistant Cr- and CrNi-steels (25%Cr-20%Ni)
High resistance to oxidation and scaling up to approx. 1100°C

SHIELDING GASES (ACC. ISO 14175)

I1 Inert gas Ar (100%)

CHEMICAL COMPOSITION (W%) TYPICAL WIRE

C	Mn	Si	Cr	Ni	Mo
0.1	1.7	0.5	26	21	0.1

MECHANICAL PROPERTIES, TYPICAL, ALL WELD METAL

	Shielding gas	Condition	0.2% proof strength [N/mm ²]	Tensile strength [N/mm ²]	Elongation [%]	Impact ISO-V(J) +20°C
Typical values	I1	AW	360	600	35	100

EXAMPLES OF MATERIALS TO BE WELDED

Steel grades	EN 10088-1/-2	EN 10213-4	Mat. Nr	ASTM/ACI	UNS
	X10CrAl24		1.4762		
		G-X25CrNiSi18-9	1.4825		
		G-X40CrNiSi22-9	1.4826		
	X15CrNiSi20-12		1.4828		
		G-X25CrNiSi20-14	1.4832		
	X15CrNiSi25-20		1.4841	3105	S31008
				CK20	J94202
	X12CrNi25-21		1.4845		
		G-X40CrNiSi25-20	1.4848	HK40	

PACKAGING AND AVAILABLE SIZES

Diameter (mm)	1.6	2.0	2.4
5 kg PE-Tube	X	X	X

LNT 310 : rev. C-EN23-01/02/16

All information in this data sheet is accurate to the best of our knowledge at the time of printing. Please refer to www.lincolnelectric.eu for any updated information. Fumes: Safety Data Sheets (SDS) are available on our website.

LINCOLN
ELECTRIC
THE WELDING EXPERTS®

LNT NiCr 60/20

CLASSIFICATION

AWS A5.14	ERNiCrMo-3	A-Nr	-	Mat-Nr	2.4831
ISO 18274	S Ni 6625 (NiCr22Mo9Nb)	F-Nr	43		
		9606 FM	6		

GENERAL DESCRIPTION

Solid rod for welding of nickel alloys
 Extreme resistance to various corrosion forms
 High chromium and molybdenum content

SHIELDING GASES (ACC. ISO 14175)

I1	Inert gas Ar (100%)
I3	Inert gas Ar+ 0.5-95% He

APPROVALS

TÜV

+

CHEMICAL COMPOSITION (W%) TYPICAL WIRE

C	Mn	Si	Ni	Cr	Mo	Nb	Fe
0.03	0.1	0.1	bal.	22	9	3.5	0.4

MECHANICAL PROPERTIES, TYPICAL, ALL WELD METAL

	Shielding gas	Condition	0.2% proof	Tensile strength	Elongation	Impact ISO-V(J)	
			strength (N/mm ²)	(N/mm ²)	(%)	+20°C	-196°C
Typical values	I1	AW	520	800	35	130	100

EXAMPLES OF MATERIALS TO BE WELDED

Ni-alloy grades	DIN/EN	Mat. Nr	ASTM/ACI	UNS
NiCrMo-steel Type alloy 625 and welding dissimilar high NiCrMo-steels for corrosion and heat resisting purposes				
	X1NiCrMoCuN25-20-6	1.4529	Alloy 925	N08925
	X1NiCrMoCu25-20-5	1.4539	Alloy 904L	N08904
	X1CrNiMoCuN20-18-7	1.4547	Alloy 254	S31254
	X2NiCrAlTi32-20	1.4558	Alloy 800L	N08800
	G-X10NiCrNb32-20	1.4859		
	X10NiCrAlTi32-20	1.4876	Alloy 800/800H	N08800/-10
	NiCr22Mo6Cu	2.4618	Alloy G	N06007
	NiCr22Mo7Cu	2.4619	Alloy G-3	N06985
	NiCr21Mo6Cu	2.4641	Alloy 825hMo	N08821
	NiCr20CuMo	2.4660	Alloy 20	N08020
	NiCr15Fe	2.4816	B168-Alloy 600	N06600
	NiCr22Mo9Nb	2.4856	B443-Alloy 625	N06625
	NiCr21Mo	2.4858	B424-Alloy 825	N08825
	NiCr20Ti	2.4951	Alloy 75	N06075
	NiCr20TiAl	2.4952	Alloy 80A	N07080
Low alloy steels				
	10Ni14 (3.5% Ni)	1.5637	ASTM A333 Grade 3	-
	12Ni19, X12Ni5	1.5680	-	K41583
9% Ni-steel for LNG storage tanks				
	X8Ni9	1.5662	A353/A353M	-
	X8Ni9 / 8%Ni	1.5662	A553/A553M Type I/II	- / K71340

PACKAGING AND AVAILABLE SIZES

Diameter (mm)	1.6	2.0	2.4	3.2	Note : Cut length = 1000 mm
2.5 kg PE-Tube	X	X	X	X	

LNT NiCr 60/20; rev. C-EN23-0102/16

All information in this data sheet is accurate to the best of our knowledge at the time of printing. Please refer to www.lincolnelectric.eu for any updated information.
 Fumes: Safety Data Sheets (SDS) are available on our website.

LNT NiCr 70/19

CLASSIFICATION

AWS A5.14	ERNiCr-3	A-Nr	-	Mat-Nr	2.4806
ISO 18274	S Ni 6082 (NiCr20Mn3Nb)	F-Nr	43		
		9606 FM	6		

GENERAL DESCRIPTION

Solid rod for welding nickel based alloys, dissimilar metals and cladding
High resistance to oxidation and high impact toughness at low temperature

SHIELDING GASES (ACC. ISO 14175)

I1	Inert gas Ar (100%)
I3	Inert gas Ar+ 0.5-95% He

APPROVALS

TÜV

+

CHEMICAL COMPOSITION (W%) TYPICAL WIRE

C	Mn	Si	Ni	Cr	Nb	Cu	Fe
0.03	3.0	0.2	bal.	20	2.5	0.1	1.0

MECHANICAL PROPERTIES, TYPICAL, ALL WELD METAL

Typical values	Shielding gas	Condition	0.2% proof strength (N/mm ²)	Tensile strength (N/mm ²)	Elongation (%)	Impact ISO-V(J)	
						+20°C	-196°C
	I1	AW	400	680	40	150	120

EXAMPLES OF MATERIALS TO BE WELDED

Ni-alloy grades	BS3076	DIN 17744/17465	Mat. Nr	ASTM/ACI	UNS
		SEW 595		B366	
Ni-base high Cr alloyed steel for low and high corrosion searching application					
	Na 14	NiCr15Fe	2.4816	B168-Alloy 600	N06600
		LC-NiCr15Fe	2.4817	Alloy 600L	N06600
		NiCr20Ti	2.4951	Alloy 75	
		NiCr20TiA1	2.4952	Alloy 80A	N07080
	Na 15	X10NiCrAlTi32-20	1.4876	Alloy 800/800H	N0800/10
		NiCr23Fe	2.4851	Alloy 601(H)	N06601
	Na 17	X12NiCrSi36-16	1.4864	330	N08330
		G-X40NiCrNb35-25	1.4852		
		G-X40NiCrSi35-25	1.4857	HP	

Un- and low alloy heat and creep resistant steel to stainless steel

APPLICATION ADVICE

Limit heat-input (HI<1.5kJ/mm) and interpass temperature (Ti<150°C)

PACKAGING AND AVAILABLE SIZES

Diameter (mm)	2.0	2.4	3.2	
2.5 kg PE-Tube	X	X	X	Note : Cut length = 1000 mm

LNT NiCr 70/19: rev. C-EN24-01/02/16

LNT NiCrMo 59/23

CLASSIFICATION

AWS A5.14	ERNiCrMo-13	A-Nr	-	Mat-Nr	2.4607
ISO 18274	S Ni 6059 (NiCr23Mo16)	F-Nr	43		
		9606 FM	6		

GENERAL DESCRIPTION

Solid rod for welding nickel base alloys with high CrMo content
Excellent resistance against pitting, stress, and crevice corrosion in acid sulfur phosphorus and chlorine surroundings
Suitable for dissimilar joints

SHIELDING GASES (ACC. ISO 14175)

I1 Inert gas Ar (100%)

APPROVALS

TÜV

+

CHEMICAL COMPOSITION (W%) TYPICAL WIRE

C	Mn	Si	Ni	Cr	Mo	Al	Fe
0.015	0.5	0.06	59	23	16	0.4	1.5

MECHANICAL PROPERTIES, TYPICAL, ALL WELD METAL

	Shielding gas	Condition	0.2% proof strength (N/mm ²)	Tensile strength (N/mm ²)	Elongation (%)	Impact ISO-V(J) +20°C
Typical values	I1	AW	400	700	25	90

EXAMPLES OF MATERIALS TO BE WELDED

Ni-alloy grades	DIN 17744	Mat. Nr	ASTM / ACI	UNS
Ni-base high CrMo steel				
	NiCr23Mo16	2.4605		N06059
	NiMo16Cr16Ti	2.4610	C-4	N06455
	NiMo16Cr15Ti	2.4819	C-276	N10276
	NiCr21Mo14W	2.4602	C-22	N06022
	NiCr22Mo9Nb	2.4856	625	N06625
High Mo stainless steel for high corrosion environments				
	EN 10088-1/-2			
	X1NiCrMoCuN25-20-7	1.4529	904hMo	N08925
	X1CrNiMoCuN20-18-7	1.4547		S31254

PACKAGING AND AVAILABLE SIZES

Diameter (mm)	1.6	2.0	2.4	
2.5 kg PE-Tube	X	X	X	Note : Cut length = 1000 mm

LNT NiCrMo 59/23: rev. C-EN23-01/02/16

All information in this data sheet is accurate to the best of our knowledge at the time of printing. Please refer to www.lincolnelectric.eu for any updated information. Fumes: Safety Data Sheets (SDS) are available on our website.

LNT NiCu 70/30

CLASSIFICATION

AWS A5.14	ERNiCu-7	A-Nr	-	Mat-Nr	2.4377
ISO 18274	S Ni 4060 (NiCu30MnTi)	F-Nr	42		
		9606 FM	6		

GENERAL DESCRIPTION

Solid rod for welding Monel and NiCu-alloys to mild and low alloy steels
 Can be used as well for welding mild and low alloy steels to NiCu alloys
 High resistance to seawater corrosion

SHIELDING GASES (ACC. ISO 14175)

I1	Inert gas Ar (100%)
I3	Inert gas Ar+ 0.5-95% He

APPROVALS

TÜV

+

CHEMICAL COMPOSITION (W%) TYPICAL WIRE

C	Mn	Si	Ni	Cu	Fe	Ti
0.06	3.5	0.5	65	30	1.1	2.0

MECHANICAL PROPERTIES, TYPICAL, ALL WELD METAL

	Shielding gas	Condition	Yield strength (N/mm ²)	Tensile strength (N/mm ²)	Elongation (%)	Impact ISO-V(J)	
						+20°C	-196°C
Typical values	I1	AW	350	560	40	160	140

EXAMPLES OF MATERIALS TO BE WELDED

Ni-alloy grades	BS3076	DIN 17743	Mat. Nr	ASTM/ACI	UNS
	NA 13	NiCu30Fe	2.4360	Monel 400	N04400
		G-NiCu30Nb	2.4365		
	NA 18	NiCu30Al	2.4375	Monel K500	N05500

PACKAGING AND AVAILABLE SIZES

Diameter (mm)	1.6	2.0	2.4	3.2	
2.5 kg PE-Tube	X	X	X	X	Note : Cut length = 1000 mm

LNT NiCu 70/30: rev. C-EN26-01/02/16

All information in this data sheet is accurate to the best of our knowledge at the time of printing. Please refer to www.lincolnelectric.eu for any updated information.
 Fumes: Safety Data Sheets (SDS) are available on our website.

LINCOLN
ELECTRIC
 THE WELDING EXPERTS®

LNT NiTi

CLASSIFICATION

AWS A5.14	ERNi1	A-Nr	-	Mat-Nr	2.4155
ISO 18274	S Ni 2061 (NiTi3)	F-Nr	41		
		9606 FM	6		

GENERAL DESCRIPTION

Solid wire for welding pure nickel and nickel alloys and joining these materials with non alloy/low alloy steel
Suitable for surfacing carbon steels

SHIELDING GASES (ACC. ISO 14175)

I1	Inert gas Ar (100%)
I3	Inert gas Ar+ 0.5-95% He

CHEMICAL COMPOSITION (W%) TYPICAL WIRE

C	Mn	Si	Ni	Ti	Fe
0.03	0.5	0.4	bal.	2.8	0.06

MECHANICAL PROPERTIES, TYPICAL, ALL WELD METAL

	Shielding gas	Condition	Yield strength (N/mm ²)	Tensile strength (N/mm ²)	Elongation (%)	Impact ISO-V(J) +20°C
Typical values	I1	AW	250	460	30	120

EXAMPLES OF MATERIALS TO BE WELDED

DIN-classification	Mat. Nr	ASTM/ACI
Ni 99.6	2.4060	
Ni 99.8	2.4050	
Ni 99.6Si	2.4056	
Ni 99.4Fe	2.4062	
Ni 99.2	2.4066	Alloy 200
LC-Ni 99	2.4068	Alloy 201
LC-Ni 99.6	2.4061	Alloy 205
NiMn10	2.4108	
NiMn5	2.4116	

PACKAGING AND AVAILABLE SIZES

Diameter [mm]	2.0	2.4	
2.5 kg PE-Tube	X	X	<i>Note : Cut length = 1000 mm</i>

LNT NiTi: rev. C-EN24-01/02/16

All information in this data sheet is accurate to the best of our knowledge at the time of printing. Please refer to www.lincolnelectric.eu for any updated information.
Fumes: Safety Data Sheets (SDS) are available on our website.

LNT CuNi30

CLASSIFICATION

AWS A5.7	ERCuNi	A-Nr	-	Mat-Nr	2.0837
EN 14640	S Cu 7158 (CuNi30)	F-Nr	34		
		9606 FM	-		

GENERAL DESCRIPTION

Solid rod for welding copper-nickel alloys containing 10-30%Ni

SHIELDING GASES (ACC. ISO 14175)

I1	Inert gas Ar (100%)
I3	Inert gas Ar+ 0.5-95% He

APPROVALS

TÜV

+

CHEMICAL COMPOSITION (W%) TYPICAL WIRE

C	Mn	Ni	Si	Ti	Fe
bal.	0.75	30	0.05	0.35	0.5

MECHANICAL PROPERTIES, TYPICAL, ALL WELD METAL

	Shielding gas	Condition	Yield strength (N/mm ²)	Tensile strength (N/mm ²)	Elongation (%)	Hardness HB	Impact ISO-V(I) +20°C
Typical values	I1	AW	250	400	30	70	100

EXAMPLES OF MATERIALS TO BE WELDED

Cu-alloy grades	Standard	Type	Mat. Nr	UNS
Copper-nickel wrought alloys				
	DIN 17664	CuNi10Fe1Mn	2.0872	C 70600
		CuNi30Mn1Fe	2.0882	C 71500
		CuNi30Fe2Mn2	2.0883	C 71600
Copper-nickel cast alloys				
	DIN 17658	G-CuNi10	2.0815	
		G-CuNi30	2.0835	

PACKAGING AND AVAILABLE SIZES

Diameter (mm)	1.6	2.0	2.4
2.5 kg PE-Tube	X	X	X

LNT CuNi30 rev. C-EN24-01/02/16

All information in this data sheet is accurate to the best of our knowledge at the time of printing. Please refer to www.lincolnelectric.eu for any updated information. Fumes: Safety Data Sheets (SDS) are available on our website.

LINCOLN
ELECTRIC
THE WELDING EXPERTS®

LNT CuSn6

CLASSIFICATION

AWS A5.7	ERCuSn-A	A-Nr	-	Mat-Nr	2.1022
EN ISO 24373	S Cu 5180 (CuSn6P)	F-Nr	33		
		9606 FM	-		

GENERAL DESCRIPTION

Solid rod for welding of copper-tin alloys

SHIELDING GASES (ACC. ISO 14175)

I1	Inert gas Ar (100%)
I3	Inert gas Ar+ 0.5-95% He

CHEMICAL COMPOSITION (W%) TYPICAL WIRE

C	Sn	P
bal.	6.0	0.2

MECHANICAL PROPERTIES, TYPICAL, ALL WELD METAL

	Shielding gas	Condition	0.2 proof strength (N/mm ²)	Tensile strength (N/mm ²)	Elongation (%)	Hardness HB	Impact ISO-V(J) +20°C
Typical values	I3	AW	150	260	20	75	80

EXAMPLES OF MATERIALS TO BE WELDED

Cu-alloy grades	Standard	Type	Mat. Nr
Copper-tin wrought alloys			
	DIN 17662	CuSn4	2.1016
		CuSn6	2.1020
		CuSn8	2.1030
Copper-tin cast alloys			
	DIN 1705	G-CuSn2ZnPb	2.1098
		G-CuSn5ZnPb	2.1096
		G-CuSn6ZnNi	2.1093

PACKAGING AND AVAILABLE SIZES

Diameter (mm)	2.0	2.4	3.2
2.5 kg PE-Tube	X	X	X

LNT CuSn6: rev. EN 27-01/02/16

All information in this data sheet is accurate to the best of our knowledge at the time of printing. Please refer to www.lincolnelectric.eu for any updated information. Fumes: Safety Data Sheets (SDS) are available on our website.

LNT CuSi3

CLASSIFICATION

AWS A5.7	ERCuSi-A	A-Nr	-	Mat-Nr	2.1461
EN ISO 24373	S Cu 6560 (CuSi3Mn)	F-Nr	32		
		9606 FM	-		

GENERAL DESCRIPTION

Solid rod for GTA-welding of low alloy copper grades
High temperature and corrosion resistant

SHIELDING GASES (ACC. ISO 14175)

I1	Inert gas Ar (100%)
I3	Inert gas Ar+ 0.5-95% He

CHEMICAL COMPOSITION (W%) TYPICAL WIRE

C	Sn	Mn	Si	Zn
bal.	0.1	1.0	3.0	0.1

MECHANICAL PROPERTIES, TYPICAL, ALL WELD METAL

	Shielding gas	Condition	Yield strength (N/mm ²)	Tensile strength (N/mm ²)	Elongation (%)	Hardness HB	Impact ISO-V(J) +20°C
Typical values	I1	AW	120	350	40	95	60

EXAMPLES OF MATERIALS TO BE WELDED

Copper, low alloy copper and copper-zinc alloys

PACKAGING AND AVAILABLE SIZES

Diameter (mm)	2.0	2.4
2.5 kg PE-Tube	X	X

LNT CuSi3 rev. C-EN24-01/02/16

All information in this data sheet is accurate to the best of our knowledge at the time of printing. Please refer to www.lincolnelectric.eu for any updated information.
Fumes: Safety Data Sheets (SDS) are available on our website.

LINCOLN
ELECTRIC
THE WELDING EXPERTS®

SuperGlaze® TIG 1070

CLASSIFICATION

ISO 18273	S Al 1070 (Al99.7)	A-Nr	-
		F-Nr	21
		Mat-Nr	3.0259

GENERAL DESCRIPTION

Highly resistant to chemical corrosion and good crack resistance
 Suitable for electrical and chemical applications utilizing aluminium base metal with little or no alloying elements
 Like all 1xxx filler alloys, Al 1070 is one of the softest aluminium MIG wire and requires extra care to ensure good feeding

SHIELDING GASES (ACC. ISO 14175)

It	Inert gas Ar (100%)
Flow rate	14.2 - 23.6L/min

CHEMICAL COMPOSITION (W%) TYPICAL WIRE

Al	Si	Fe	Cu	Mn	Mg	Cr	Zn	V	Ti	Be
min. 99.7	max. 0.2	max. 0.25	max. 0.04	max. 0.03	max. 0.03	0	max. 0.04	max. 0.05	max. 0.03	max. 0.0003

Notes : Unspecified elements should not exceed a total of 0.03%

MECHANICAL PROPERTIES, TYPICAL, ALL WELD METAL

	Shielding gas	Condition	Yield strength [N/mm ²]	Tensile strength [N/mm ²]	Elongation [%]
Typical values	It	AW	20-30	65-80	29-35

PHYSICAL PROPERTIES

Melting range	: 647 - 658°C
Density	: approximately 2700 kg/m ³

APPLICATIONS

Joining 1xxx alloys to themselves or other alloys
 Bus Bars
 Electrical Boxes

Heat Exchangers
 Metallizing
 Electro-technical, Chemical, Construction and Food Industry

PACKAGING AND AVAILABLE SIZES

Diameter (mm)	2.0	2.4	3.2	Note : Cut length = 1000 mm
5 kg cardboard box	X	X	X	

Superglaze® TIG 1070: rev. C-EN02-01/02/16

All information in this data sheet is accurate to the best of our knowledge at the time of printing. Please refer to www.lincolnelectric.eu for any updated information. Fumes: Safety Data Sheets (SDS) are available on our website.

SuperGlaze® TIG 1100

CLASSIFICATION

AWS 5.10	R1100	A-Nr	-
ISO 18273	S Al 1100 (Al99.0Cu)	F-Nr	21
EN 573.3	EN AW-Al99.0Cu	Mat-Nr	-

GENERAL DESCRIPTION

Highly resistant to chemical corrosion and good crack resistance
 Suitable for electrical and chemical applications utilizing aluminium base metal with little or no alloying elements
 Like all 1xxx filler alloys, Al 1100 is one of the softest aluminium MIG wire and requires extra care to ensure good feeding

SHIELDING GASES (ACC. ISO 14175)

It	Inert gas Ar (100%)
Flow rate	14.2 - 23.6L/min

CHEMICAL COMPOSITION (W%) TYPICAL WIRE

Al	Si	Fe	Cu	Mn	Mg	Cr	Zn	Ti	Be
min. 99.0	A	A	0.05-0.20	max. 0.05	0	0	max. 0.10	0	max. 0.0003

Notes : A = Si+Fe max. 0.95

Notes : Unspecified elements should not exceed a total of 0.15%

MECHANICAL PROPERTIES, TYPICAL, ALL WELD METAL

	Shielding gas	Condition	Yield strength [N/mm ²]	Tensile strength [N/mm ²]	Elongation [%]
Typical values	It	AW	20-30	65-80	29-35

PHYSICAL PROPERTIES

Melting range	: 647 - 658°C
Density	: approximately 2700 kg/m ³

APPLICATIONS

Joining 1xxx alloys to themselves or other alloys	Heat Exchangers
Bus Bars	Metallizing
Electrical Boxes	Electro-technical, Chemical, Construction and Food Industry

PACKAGING AND AVAILABLE SIZES

Diameter (mm)	1.6	2.0	2.4	3.2	4.0	Note : Cut length = 1000 mm
5 kg cardboard box	X	X	X	X	X	

SuperGlaze® TIG 1100 rev. C-EN01-01/02/16

All information in this data sheet is accurate to the best of our knowledge at the time of printing. Please refer to www.lincolnelectric.eu for any updated information. Fumes: Safety Data Sheets (SDS) are available on our website.

LINCOLN
ELECTRIC
 THE WELDING EXPERTS®

SuperGlaze® TIG 4043

CLASSIFICATION

AWS 5.10	R4043	A-Nr	-
ISO 18273	S Al 4043A (AlSi5)	F-Nr	23
EN 573.3	EN AW-AISi5	Mat-Nr	3.2245

GENERAL DESCRIPTION

Designed for welding heat treatable base alloys and more specifically 6xxx Series Alloys
 Lower melting point and fluidity than 5xxx series filler alloys
 Low sensitivity to weld cracking with 6xxx base alloys
 Suitable for sustained elevated temperature service. i.e. above 650C

SHIELDING GASES (ACC. ISO 14175)

I1	Inert gas Ar (100%)
Flow Rate	: 14.2 - 23.6 L/min

APPROVALS

ABS	DB	TÜV
+	+	+

CHEMICAL COMPOSITION (W%) TYPICAL WIRE

Al	Si	Fe	Cu	Mn	Mg	Cr	Zn	Ti	Be
bal.	4.5-6.0	max. 0.6	0.05-0.020	max. 0.05	0	-	max. 0.1	0	max. 0.0003

Notes : Unspecified elements should not exceed a total of 0.15%

MECHANICAL PROPERTIES. TYPICAL. ALL WELD METAL

	Shielding gas	Condition	Yield strength (N/mm ²)	Tensile strength (N/mm ²)	Elongation (%)
Typical values	I1	AW	20-40	120-165	3-18

PHYSICAL PROPERTIES

Melting range	: 573 - 625°C
Density	: approximately 2680 kg/m3

APPLICATIONS

For welding 6XXX alloys, and most casting alloys
 Automotive components such as frame and drive shafts
 Bicycle frames

PACKAGING AND AVAILABLE SIZES

Diameter (mm)	1.6	2.0	2.4	3.2	4.0	4.8	
5 kg cardboard box	X	X	X	X	X	X	Note : Cut length = 1000 mm

Superglaze® TIG 4043: rev. C-EN22-01/02/16

SuperGlaze® TIG 4047

CLASSIFICATION

AWS 5.10	R4047	A-Nr	-
ISO 18273	S Al 4047 (AlSi12)	F-Nr	23
EN 573.3	EN AW-AlSi12	Mat-Nr	3.2585

GENERAL DESCRIPTION

Lower melting point and higher fluidity than 4043 wires

Can be used as a substitute for 4043 to increase silicon content in the weld metal and minimize hot cracking and produce higher fillet weld shear strength

Can be used as a brazing alloy

SHIELDING GASES (ACC. ISO 14175)

It	Inert gas Ar (100%)
Flow Rate	: 14.2 - 23.6 L/min

CHEMICAL COMPOSITION (W%) TYPICAL WIRE

Al	Si	Fe	Cu	Mn	Mg	Cr	Zn	Ti	Be
bal.	11-13	max. 0.8	max. 0.30	max. 0.15	0.10	0	max. 0.20	0	max. 0.0003

Notes : Unspecified elements should not exceed a total of 0.15%

MECHANICAL PROPERTIES, TYPICAL, ALL WELD METAL

	Shielding gas	Condition	Yield strength (N/mm ²)	Tensile strength (N/mm ²)	Elongation (%)
Typical values	It	AW	60-80	130-190	5-20

PHYSICAL PROPERTIES

Melting range	: 573 - 585°C
Density	: approximately 2680 kg/m ³

APPLICATIONS

For welding 6XXX alloys, and most casting alloys
Automotive components, radiators and air conditioning

PACKAGING AND AVAILABLE SIZES

Diameter (mm)	2.0	2.4	3.2	4.0	Note : Cut length = 1000 mm
5 kg cardboard box	X	X	X	X	

Superglaze® TIG 4047: rev. C-EN22-01/02/16

All information in this data sheet is accurate to the best of our knowledge at the time of printing. Please refer to www.lincolnelectric.eu for any updated information. Fumes: Safety Data Sheets (SDS) are available on our website.

LINCOLN
ELECTRIC
THE WELDING EXPERTS®

SuperGlaze® TIG 5087

CLASSIFICATION

ISO 18273	S Al 5087 (AlMg4,5MnZr)	A-Nr	-
		F-Nr	22
		Mat-Nr	3.3546

GENERAL DESCRIPTION

Designed to meet the tensile strength requirements of high magnesium alloys
 For base metals with a max. of 5% Mg
 The presence of Zirconium produces a fine-grained weld metal structure
 Reduced tendency of solidification cracking in highly restrained welds

SHIELDING GASES (ACC. ISO 14175)

I1	: Inert gas Ar (100%)
I3	: Inert gas Ar+ 0.5-95% He
Flow Rate	: 8 - 15 L/min

APPROVALS

GL	LR	DB	TÜV	WIWeb
+	+	+	+	+

**(Valid for I1 and I3 gases)*

CHEMICAL COMPOSITION (W%) TYPICAL WIRE

Al	Si	Fe	Cu	Mn	Mg	Cr	Zn	Ti	Zr	Be
bal.	max. 0.25	max. 0.4	max. 0.05	0.7-1.1	4.5-5.2	0.05-0.25	max. 0.25	max. 0.15	0.10-0.20	max. 0.0003

Notes : Unspecified elements should not exceed a total of 0.15%

MECHANICAL PROPERTIES. TYPICAL. ALL WELD METAL

	Shielding gas	Condition	Yield strength [N/mm ²]	Tensile strength [N/mm ²]	Elongation [%]
Typical values	I1	AW	125-140	275-300	17-30

PHYSICAL PROPERTIES

Melting range	: 568 - 638°C
Density	: approximately 2660 kg/m3

APPLICATIONS

Marine fabrication and repair	Railway Industry
Cryogenic tanks	Automotive Industry
Shipbuilding and other high strength structural aluminium applications	Trailer Industry and Offshore

PACKAGING AND AVAILABLE SIZES

Diameter (mm)	1.6	2.0	2.4	3.2	4.0	4.8
5 kg cardboard box	X	X	X	X	X	X

SuperGlaze® TIG 5087: rev. C-EN02-01/02/15

All information in this data sheet is accurate to the best of our knowledge at the time of printing. Please refer to www.lincolnelectric.eu for any updated information. Fumes: Safety Data Sheets (SDS) are available on our website.

SuperGlaze® TIG 5183

CLASSIFICATION

AWS 5.10	R5183	A-Nr	-
ISO 18273	S Al 5183 [AlMg4.5Mn0.7(A)]	F-Nr	22
EN 573.3	EN AW-AlMg4.5Mn	Mat-Nr	3.3548

GENERAL DESCRIPTION

Designed to meet the tensile strength requirements of magnesium alloys
For base materials 5083 and 5654

SHIELDING GASES (ACC. ISO 14175)

I1	: Inert gas Ar (100%)
I3	: Inert gas Ar+ 0.5-95% He
Flow Rate	: 8 - 15 L/min

APPROVALS

ABS	GL	LR	DB	TÜV	DNV	BV	WIWeb
+	+	+	+	+	+	+	+

CHEMICAL COMPOSITION (W%) TYPICAL WIRE

Al	Si	Fe	Cu	Mn	Mg	Cr	Zn	Ti	Be
bal.	max. 0.4	max. 0.4	max. 0.1	0.5-1.0	4.3-5.2	0.05-0.25	max. 0.25	max. 0.15	max. 0.0003

Notes : Unspecified elements should not exceed a total of 0.15%

MECHANICAL PROPERTIES. TYPICAL. ALL WELD METAL

	Shielding gas	Condition	Yield strength [N/mm ²]	Tensile strength [N/mm ²]	Elongation [%]
Typical values	I1	AW	125-165	270-290	16-25

PHYSICAL PROPERTIES

Melting range	: 568 - 638°C
Density	: approximately 2660 kg/m3

APPLICATIONS

Marine fabrication and repair	Military Industry
Cryogenic tanks	Railway & Automotive Industry
Shipbuilding and other high strength structural aluminium applications	Trailer Industry and Offshore

PACKAGING AND AVAILABLE SIZES

Diameter (mm)	1.6	2.0	2.4	3.2	4.0
5 kg cardboard box	X	X	X	X	X

SuperGlaze® TIG 5183: rev. C-EN23-01/02/16

All information in this data sheet is accurate to the best of our knowledge at the time of printing. Please refer to www.lincolnelectric.eu for any updated information. Fumes: Safety Data Sheets (SDS) are available on our website.

LINCOLN
ELECTRIC
THE WELDING EXPERTS®

SuperGlaze® TIG 5356

CLASSIFICATION

AWS 5.10	R5356	A-Nr	-
ISO 18273	S Al 5356 (AlMg5Cr(A))	F-Nr	22
EN 573.3	EN AW-AlMg5	Mat-Nr	3.3556

GENERAL DESCRIPTION

General purpose filler alloy for welding 5XXX series alloys when 276 MPa tensile strength is not required.
Excellent colour match after anodizing

SHIELDING GASES (ACC. ISO 14175)

I1	: Inert gas Ar (100%)
I3	: Inert gas Ar+ 0.5-95% He
Flow Rate	: 8 - 15 L/min

APPROVALS

ABS	GL	LR	DB	TÜV	DNV	BV
+	+	+	+	+	+	+

CHEMICAL COMPOSITION (W%) TYPICAL WIRE

Al	Si	Fe	Cu	Mn	Mg	Cr	Zn	Ti	Be
bal.	max. 0.25	max. 0.4	max. 0.1	0.05-0.2	4.5-5.5	0.05-0.20	max. 0.1	0.06-0.2	max. 0.0003

Notes : Unspecified elements should not exceed a total of 0.15%

MECHANICAL PROPERTIES. TYPICAL. ALL WELD METAL

	Shielding gas	Condition	Yield strength [N/mm ²]	Tensile strength [N/mm ²]	Elongation [%]
Typical values	I1	AW	110-120	240-296	17-26

PHYSICAL PROPERTIES

Melting range	: 562 - 633°C
Density	: approximately 2640 kg/m3

APPLICATIONS

Structural frames in the shipbuilding industry
Furniture, Storage tanks
Railway Industry

Automotive and trailer Industry
Formed truck panels
Automotive bumpers and supports

PACKAGING AND AVAILABLE SIZES

Diameter (mm)	1.6	2.0	2.4	3.2	4.0	5.0	
5 kg cardboard box	X	X	X	X	X	X	<i>Note : Cut length = 1000 mm</i>

SuperGlaze® TIG 5356 rev. C-EN22-01/02/16

SuperGlaze® TIG 5554

CLASSIFICATION

AWS 5.10	R5554	A-Nr	-
ISO 18273	Al 5554	F-Nr	
		Mat-Nr	

GENERAL DESCRIPTION

SHIELDING GASES (ACC. ISO 14175)

I1	: Inert gas Ar (100%)
I3	: Inert gas Ar+ 0.5-95% He
Flow Rate	: 8 - 15 L/min

APPROVALS

ABS

+

CHEMICAL COMPOSITION (W%) TYPICAL WIRE

Al	Si	Fe	Cu	Mn	Mg	Cr	Zn	Ti	Be
bal.	max. 0.25	max. 0.4	max. 0.1	0.5-1.0	4.7-5.5	0.05-0.20	max. 0.25	0.05-0.20	max. 0.0003

Notes : Unspecified elements should not exceed a total of 0.15%

MECHANICAL PROPERTIES. TYPICAL. ALL WELD METAL

	Shielding gas	Condition	Yield strength (N/mm ²)	Tensile strength (N/mm ²)	Elongation [%]
Typical values	I1	AW	125-145	275-295	17-25

PHYSICAL PROPERTIES

Melting range	: 562 - 633°C
Density	: approximately 2660 kg/m3

APPLICATIONS

Structural frames in the shipbuilding industry
Furnitures. Storage tanks
Railway Industry

Automotive and trailer Industry
Formed truck panels
Automotive bumpers and supports

PACKAGING AND AVAILABLE SIZES

Diameter (mm)	1.6	2.0	2.4
5 kg cardboard box	X	X	X

Superglaze® TIG 5554 rev. C-EN01-01/02/16

All information in this data sheet is accurate to the best of our knowledge at the time of printing. Please refer to www.lincolnelectric.eu for any updated information. Fumes: Safety Data Sheets (SDS) are available on our website.

LINCOLN
ELECTRIC
THE WELDING EXPERTS®

SuperGlaze® TIG 5754

CLASSIFICATION

AWS 5.10	Al 5754	A-Nr	-
ISO 18273	S Al 5754 (AlMg3)	F-Nr	22
		Mat-Nr	3.3536

GENERAL DESCRIPTION

Magnesium alloyed aluminium for welding of alloys with a maximum of 3.5% Mg
 Good corrosion resistance and excellent colour match after anodizing
 Suitable for a wide range of applications in general construction and structural industry

SHIELDING GASES (ACC. ISO 14175)

I1	: Inert gas Ar (100%)
I3	: Inert gas Ar+ 0.5-95% He
Flow Rate	: 8 - 15 L/min

APPROVALS

TÜV

+

CHEMICAL COMPOSITION (W%) TYPICAL WIRE

Al	Si	Fe	Cu	Mn	Mg	Cr	Zn	Ti	Be
bal.	max. 0.4	max. 0.4	max. 0.1	max. 0.5	2.6-3.6	max. 0.3	max. 0.20	max. 0.15	max. 0.0003

Notes : Unspecified elements should not exceed a total of 0.15%

MECHANICAL PROPERTIES. TYPICAL. ALL WELD METAL

	Shielding gas	Condition	Yield strength (N/mm ²)	Tensile strength (N/mm ²)	Elongation (%)
Typical values	I1	AW	70-80	180-200	15-20

PHYSICAL PROPERTIES

Melting range	: 580 - 642°C
Density	: approximately 2660 kg/m3

APPLICATIONS

General Construction Industry
 Automotive bumpers and supports

PACKAGING AND AVAILABLE SIZES

Diameter (mm)	1.6	2.0	2.4	3.2	4.0	Note : Cut length = 1000 mm
5 kg cardboard box	X	X	X	X	X	

Superglaze® TIG 5754: rev. C-EN01-01/02/16

LNG I

CLASSIFICATION

AWS 5.2	R45*	A-Nr	1	Mat-Nr	1.0324
EN 12536	0 I	F-Nr	6		
	* Nearest classification	Mat-Nr	-		

GENERAL DESCRIPTION

Rods for oxy-acetylene gas welding of general construction steel
 Suitable for mild steel
 Max. design temperature 350°C

CHEMICAL COMPOSITION (W%) TYPICAL WIRES

C	Mn	Si	P	S	Cr	Ni	Mo
0.07	0.5	0.1	0.01	0.01	0.04	0.03	0.01

MECHANICAL PROPERTIES, TYPICAL, ALL WELD METAL

	Condition	Yield strength (N/mm ²)	Tensile strength (N/mm ²)	Elongation (%)	Impact ISO-V(J) +20°C
Typical values	AW	280	390	16	50

EXAMPLES OF MATERIALS TO BE WELDED

Steel grades	Type
Pipe material	L210 up to L290
General structural steels	S185 up to S275

PACKAGING AND AVAILABLE SIZES

Diameter (mm)	2.0	3.0
5 kg cardboard box	X	X

LNG I rev. C-EN23-01/02/16

All information in this data sheet is accurate to the best of our knowledge at the time of printing. Please refer to www.lincolnelectric.eu for any updated information. Fumes: Safety Data Sheets (SDS) are available on our website.



LNG II

CLASSIFICATION

AWS 5.2	R60*	A-Nr	1	Mat-Nr	1.0349
EN 12536	O II	F-Nr	6		
	* Nearest classification	Mat-Nr	-		

GENERAL DESCRIPTION

Rods for oxy-acetylene gas welding of general construction steel
 Suitable for mild steel
 max. design temperature 350°C
 Higher strength than LNG I

CHEMICAL COMPOSITION (W%) TYPICAL WIRES

C	Mn	Si	P	S
0.10	1.1	0.15	0.01	0.01

MECHANICAL PROPERTIES, TYPICAL, ALL WELD METAL

	Condition	Yield strength (N/mm ²)	Tensile strength (N/mm ²)	Elongation (%)	Impact ISO-V(J) +20°C
Typical values	AW	320	430	17	60

EXAMPLES OF MATERIALS TO BE WELDED

Steel grades	Type
Pipe material	L210 up to L290
General structural steels	Si85 up to S275

PACKAGING AND AVAILABLE SIZES

Diameter (mm)	1.6	2.0	2.5	3.0	4.0
5 kg cardboard box	X	X	X	X	X

LNG II: rev. C-EN23-01/02/16

All information in this data sheet is accurate to the best of our knowledge at the time of printing. Please refer to www.lincolnelectric.eu for any updated information. Fumes: Safety Data Sheets (SDS) are available on our website.

LNG IV

CLASSIFICATION

AWS 5.2	R65*	A-Nr	2	Mat-Nr	1.5425
EN 12536	O IV	F-Nr	6		
	* Nearest classification	Mat-Nr	-		

GENERAL DESCRIPTION

Rods with 0.5% Mo for oxy-acetylene gas welding of fine grained and creep resisting steel
Design temperature max. 500°C

APPROVALS

TÜV

+

CHEMICAL COMPOSITION (W%) TYPICAL WIRES

C	Mn	Si	P	S	Mo
0.09	1.0	0.19	0.01	0.01	0.50

MECHANICAL PROPERTIES, TYPICAL, ALL WELD METAL

	Condition	Yield strength	Tensile strength	Elongation	Impact ISO-V(J)
		(N/mm ²)	(N/mm ²)	(%)	+20°C
Typical values	AW	380	500	22	60

EXAMPLES OF MATERIALS TO BE WELDED

Steel grades	Standard	Type
Pipe material	EN 10208-2	L210 up to L290
General structural steels		S185 up to S275
Boiler and pressure vessel steel		P295, P355, 16Mo3

PACKAGING AND AVAILABLE SIZES

Diameter (mm)	2.0	2.5	3.0	4.0
5 kg cardboard box	X	X	X	X

LNG IV: rev. C-EN23-01/02/16

All information in this data sheet is accurate to the best of our knowledge at the time of printing. Please refer to www.lincolnelectric.eu for any updated information. Fumes: Safety Data Sheets (SDS) are available on our website.



GTAW



Lined area for notes, consisting of multiple horizontal lines within a rectangular border.

FLUX-CORED WIRES

OUTERSHIELD

Metal cored, un- and low alloyed
 Outershield® MC700 406
 Outershield® MC710-H 408
 Outershield® MC710C-H 410
 Outershield® MC715-H 412
 Outershield® MC715-Ni1-H 414
 Outershield® MC420N-H 416
 Outershield® MC460VD-H 418

Rutile and Basic, Un-alloyed

Outershield® 70-H 420
 Outershield® 71E-H 422
 Outershield® 71M-H 424
 Outershield® 71MS-H 426
 Outershield® T55-H 428

Rutile, low alloyed, gas shielded

Outershield® 81Ni1-H 430
 Outershield® 81Ni1-HSR 432
 Outershield® 81NiC-H 434
 Outershield® 81K2-H 436
 Outershield® 81K2-HSR 438
 Outershield® 91Ni1-HSR 440
 Outershield® 91K2-HSR 442
 Outershield® 101Ni1-HSR 444
 Outershield® 690-H 446
 Outershield® 690-HSR 448

Rutile and Metal Cored, weather resistant

Outershield® 500CT-H 450
 Outershield® 555CT-H 452
 Outershield® MC555CT-H 454

Rutile, Heat and Creep Resistant

Outershield® 12-H 456
 Outershield® 19-H 458
 Outershield® 20-H 460

INNERSHIELD (self shielded)

Innershield® NR®-152 462
 Innershield® NR®-203 NiC 464
 Innershield® NR®-203Ni1 466
 Innershield® NR®-211-MP 468
 Innershield® NR®-232 470
 Innershield® NR®-233 472
 Innershield® NR®-207-H 474
 Innershield® NR®-208-H 476
 Innershield® NR®-305 478
 Innershield® NR®-311 480
 Innershield® NR®-400 482
 Innershield® NS®-3M 484

COR-A-ROSTA (stainless steel, gas shielded)

Cor-A-Rosta® 304L 486
 Cor-A-Rosta® P304L 488
 Cor-A-Rosta® 347 490
 Cor-A-Rosta® 316L 492
 Cor-A-Rosta® P316L 494
 Cor-A-Rosta® 309L 496
 Cor-A-Rosta® P309L 498
 Cor-A-Rosta® 309MoL 500
 Cor-A-Rosta® P309MoL 502
 Cor-A-Rosta® 4462 504
 Cor-A-Rosta® P4462 506

LINCORE (Hardfacing, self shielded)

Lincore® 33 508
 Lincore® 40-O 510
 Lincore® 50 512
 Lincore® 55 514
 Lincore® 60-O 516
 Lincore® T&D 518
 Lincore® 15CrMn 520
 Lincore® 420 522
 Lincore® M 524

New!

Outershield® 71MS-H (CO₂)
 with outstanding mechanical properties at

-40°C

Outershield® MC700

CLASSIFICATION

AWS A5.18	E70C-6M H8	A-Nr	1
EN ISO 17632-A	T 46 2 M M 2 H10	F-Nr	6
		9606 FM	1

GENERAL DESCRIPTION

All position high efficiency gas shielded metal cored wire
 Excellent arc characteristics give outstanding operator appeal
 Very few silicates, virtually no spatter, fast travel speed, excellent wire feeding
 Superior product consistency with optimal alloy control

WELDING POSITIONS (ISO/ASME)



PA/1G



PB/2F



PC/2G



PF/3Gu



PE/4G

CURRENT TYPE / SHIELDING GAS (ISO 14175)

DC +
 M21 : Mixed gas Ar+ (>15-25%) CO₂
 Flow rate: 15-25 l/min

CHEMICAL COMPOSITION (W%), TYPICAL, ALL WELD METAL

Shielding gas	C	Mn	Si	P	S	HDM
M21	0.05	1.35	0.6	0.015	0.023	5 ml/100 g

MECHANICAL PROPERTIES, TYPICAL, ALL WELD METAL

	Shielding gas	Condition	Yield strength [N/mm ²]	Tensile strength [N/mm ²]	Elongation [%]	Impact ISO-V(J)	
						-20°C	-30°C
Required: AWS A5.18 EN ISO 17632-A			min. 400 min. 460	min. 480 530-680	min. 22 min. 20	min. 47	min. 27
Typical values	M21	AW	475	560	24	75	45

PACKAGING AND AVAILABLE SIZES

Diameter (mm)	1.2
15 kg spool B300	X

Outershield® MC700: rev. C-EN05-01/02/16

All information in this data sheet is accurate to the best of our knowledge at the time of printing. Please refer to www.lincolnelectric.eu for any updated information.
 Fumes: Safety Data Sheets (SDS) are available on our website.

Outershield® MC700

EXAMPLES OF MATERIALS TO BE WELDED

Steel grades/Standard	Type
General structural steels	
EN 10025	S185, S235, S275, S355
Ship plates	
ASTM A131	Grade A, B, D, AH32 to EH36
Cast steels	
EN 10213-2	G P 240R
Pipe material	
EN 10208-1	L210, L240, L290, L360
EN 10208-2	L240NB, L290NB, L360NB, L360QB, L240MB, L290MB, L360MB, L415MB, L415NB
API 5LX	X42, X46, X52, X60
EN 10216-1/	P235T1, P235T2, P275T1
EN 10217-1	P275T2, P355N
Boiler & pressure vessel steels	
EN 10028-2	P235GH, P265GH, P295GH, P355GH
Fine grained steels	
EN 10025 part 3	S275, S355, S420
EN 10025 part 4	S275M, S275ML, S355M, S355ML, S420M, S420ML

CALCULATION DATA

Diameter (mm)	Arc mode	Electrical stick-out (mm)	Wire Feed Speed (cm/min)	Current (A)	Arc Voltage (V)	Deposition rate (kg/h)	kg wire/kg weldmetal
1.2	Short arc	15	230	100	15	1.1	1.10
			320	120	16	1.4	1.10
			400	150	17	1.9	1.10
1.2	Spray arc	20	635	180	28-30	2.7	1.10
			940	275	31-34	4.8	1.10
			1420	340	35-38	6.8	1.10

FCAW

WELDING PARAMETERS, OPTIMUM FILL PASSES IN SHIELDING GAS Ar + (>15-25)% CO₂

Diameter (mm)	Welding positions				
	PA/1G	PB/2F	PC/2G	PF/3Gup	PE/4G
1.2	230-280A	230-380A	230-300A	130-170A	140-175A
	26-36V	26-36V	26-30V	15-17V	16-17V

Outershield® MC710-H

CLASSIFICATION

AWS A5.18	E70C-6M H4	A-Nr	1
EN ISO 17632-A	T 46 3 M M 2 H5 (ø1.2 and 1.6 mm)	F-Nr	6
	T 46 2 M M 2 H5 (ø2.0 and 2.4 mm)	9606 FM	1

GENERAL DESCRIPTION

All position high efficiency gas shielded metal cored wire
 Excellent arc characteristics give outstanding operator appeal
 Very few silicates, virtually no spatter, fast travel speed, excellent wire feeding
 Superior on scaled plate, good resistance to porosity
 Very good mechanical properties [CVN >47J at -30°C]
 Superior product consistency with optimal alloy control

WELDING POSITIONS (ISO/ASME)

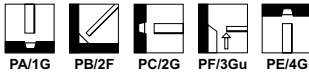

CURRENT TYPE / SHIELDING GAS (ISO 14175)

DC +
 M21 : Mixed gas Ar+ (>15-25%) CO₂
 Flow rate: 15-25 l/min

APPROVALS

Shielding gas	ABS	BV	DB	DNV	GL	LR	RINA	RMRS	TÜV
M21	3YSAH5	SA3YMH5	+	IIIVMS(H5)	3YH5S	3YSH5	3YS	3YSH5	+

CHEMICAL COMPOSITION (W%), TYPICAL, ALL WELD METAL

Shielding gas	C	Mn	Si	P	S	HDM
M21	0.05	1.35	0.6	0.015	0.023	3 ml/100 g

MECHANICAL PROPERTIES, TYPICAL, ALL WELD METAL

	Shielding gas	Condition	Yield strength [N/mm ²]	Tensile strength [N/mm ²]	Elongation [%]	Impact ISO-V[J]		
						-20°C	-29°C/-30°C	-40°C
Required: AWS A5.18			min. 400	min. 480	min. 22		min. 27	
EN ISO 17632-A (1.2-1.6)			min. 460	530-680	min. 20		min. 47	
Typical values	M21	AW	495	570	26	90	60	
	M21	SR	430	530	28		105	75

SR : 15h/580°C

PACKAGING AND AVAILABLE SIZES

Diameter (mm)	1.0	1.2	1.4	1.6
5 kg plastic spool S200	X	X		
15 kg spool B300	X	X	X	X
25 kg wire reel B435			X	X
200 kg Accutrak® Drum	X	X	X	X
270 kg metal coil				X

Outershield® MC710-H: rev. C-EN23-19/04/16

All information in this data sheet is accurate to the best of our knowledge at the time of printing. Please refer to www.lincolnelectric.eu for any updated information.
 Fumes: Safety Data Sheets (SDS) are available on our website.

Outershield® MC710-H

EXAMPLES OF MATERIALS TO BE WELDED

Steel grades/Standard	Type
General structural steels	
EN 10025	S185, S235, S275, S355
Ship plates	
ASTM A131	Grade A, B, D, AH32 to EH36
Cast steels	
EN 10213-2	G P 240R
Pipe material	
EN 10208-1	L210, L240, L290, L360
EN 10208-2	L240NB, L290NB, L360NB, L360QB, L240MB, L290MB, L360MB, L415MB, L415NB
API 5LX	X42, X46, X52, X60, X65
EN 10216-1/	P235T1, P235T2, P275T1
EN 10217-1	P275T2, P355N
Boiler & pressure vessel steels	
EN 10028-2	P235GH, P265GH, P295GH, P355GH
Fine grained steels	
EN 10025 part 3	S275, S355, S420, S460
EN 10025 part 4	S275M, S275ML, S355M, S355ML, S420M, S420ML, S460M, S460ML

CALCULATION DATA

Diameter (mm)	Arc mode	Electrical stick-out (mm)	Wire Feed Speed (cm/min)	Current (A)	Arc Voltage (V)	Deposition rate (kg/h)	kg wire/ kg weldmetal
1.2	Short arc	15	230	100	15	1.1	1.10
			320	120	16	1.4	1.10
			400	150	17	1.9	1.10
1.2	Spray arc	20	940	275	31-34	4.8	1.10
			1420	340	35-38	6.8	1.10
			445	170	27-29	2.5	1.10
1.4	Spray arc	25	890	270	29-32	5.0	1.10
			1400	355	32-34	8.1	1.10
			635	325	29-32	5.0	1.10
1.6	Spray arc	25	890	400	34-37	7.0	1.10
			1145	460	36-38	9.1	1.10
			320	290	25-27	3.7	1.05
2.0	Spray arc	28	510	385	28-31	6.1	1.05
			760	510	32-35	9.3	1.05
			400	280	28-32		
2.4	Spray arc	30	475	475	28-32		
			550	550	30-34		

WELDING PARAMETERS, OPTIMUM FILL PASSES IN SHIELDING GAS Ar + [>15-25]% CO₂

Diameter (mm)	Welding positions				
	PA/1G	PB/2F	PC/2G	PF/3Gup	PE/4G
1.2	230-380A	230-380A	230-300A	130-170A	140-175A
	26-36V	26-36V	26-30V	15-17V	16-17V
1.4	240-385A	240-385A	240-340A	160-180A	175-185A
	26-36V	26-36V	26-31V	14-15V	15-16V
1.6	280-460A	280-460A	270-300A		
	28-36V	28-36V	28-30V		
2.0	300-510A	300-510A			
	28-33V	28-33V			
2.4	400-550A	400-550A			
	32-36V	32-36V			

Outershield® MC710C-H

CLASSIFICATION

AWS A5.18	E70C-6C H4	A-Nr	1
EN ISO 17632-A	T 46 3 M C 2 H5	F-Nr	6
		9606 FM	1

GENERAL DESCRIPTION

All position high efficiency CO₂ shielded metal cored wire
 Excellent arc characteristics give outstanding operator appeal
 Few silicates and virtually no spatter, fast travel speed, excellent wire feeding
 Superior on primed or scaled plate, high resistance to porosity on primed plate
 Very good mechanical properties [CVN >4J] at -30°C
 Superior product consistency with optimal alloy control

WELDING POSITIONS (ISO/ASME)



CURRENT TYPE / SHIELDING GAS (ISO 14175)

DC +
 C1 : Active gas 100%
 Flow rate : 15-25 l/min

APPROVALS

Shielding gas	ABS	BV	DNV	GL	LR	RINA	TÜV
C1	3YSAH5	3YH5	III YMS	3YH5	3YH5	3YSh5	+

CHEMICAL COMPOSITION (W%), TYPICAL, ALL WELD METAL

Shielding gas	C	Mn	Si	P	S	HDM
C1	0.05	1.35	0.6	0.015	0.023	3 ml/100 g

MECHANICAL PROPERTIES, TYPICAL, ALL WELD METAL

	Shielding gas	Condition	Yield strength (N/mm ²)	Tensile strength (N/mm ²)	Elongation (%)	Impact ISO-V(J)	
						-20°C	-29°C/-30°C
Required: AWS A5.18 EN ISO 17632-A			min. 400 min. 460	min. 480 530-680	min. 22 min. 20		min. 27 min. 47
Typical values	C1	AW	490	585	27	90	70

PACKAGING AND AVAILABLE SIZES

Diameter (mm)	1.2
15 kg spool B300	X

Outershield® MC710C-H: rev. C-EN25-01/02/16

All information in this data sheet is accurate to the best of our knowledge at the time of printing. Please refer to www.lincolnelectric.eu for any updated information.
 Fumes: Safety Data Sheets (SDS) are available on our website.

Outershield® MC710C-H

EXAMPLES OF MATERIALS TO BE WELDED

Steel grades/Standard	Type
General structural steels	
EN 10025 part 2	S185, S235, S275, S355
Ship plates	
ASTM A131	Grade A, B, D, AH32 to EH36
Cast steels	
EN 10213-2	G P 240R
Pipe material	
EN 10208-1	L210, L240, L290, L360
EN 10208-2	L240NB, L290NB, L360NB, L360QB, L240MB, L290MB, L360MB, L415MB, L415NB
API 5LX	X42, X46, X52, X60
Fine grained steels	
EN 10025 part 3	S275, S355, S420
EN 10025 part 4	S275M, S275ML, S355M, S355ML, S420M, S420ML, S460

CALCULATION DATA

Diameter (mm)	Arc mode	Electrical stick-out (mm)	Wire Feed Speed (cm/min)	Current (A)	Arc Voltage (V)	Deposition rate (kg/h)	kg wire/ kg weldmetal
1.2	Short arc	15	230	100	15	1.1	1.10
			320	120	16.5	1.4	1.10
			400	150	17	1.9	1.10
1.2	Spray arc	20	635	180	28-30	2.7	1.10
			940	275	31-34	4.8	1.10
			1420	340	35-38	6.8	1.10

FCAW

WELDING PARAMETERS, OPTIMUM FILL PASSES IN SHIELDING GAS Ar + (>15-25)% CO₂

Diameter (mm)	Welding positions				
	PA/1G	PB/2F	PC/2G	PF/3Gup	PE/4G
1.2	230-380A	230-380A	230-300A	100-170A	140-175A
	26-36V	26-36V	26-30V	16-17V	16-17V

Outershield® MC715-H

CLASSIFICATION

AWS A5.18	E70C-6M H4	A-Nr	1
EN ISO 17632-A	T 46 4 M M 2 H5	F-Nr	6
		9606 FM	1

GENERAL DESCRIPTION

Metal cored gas shielded wire for all positions
 Few silicates and virtually no spatter, fast travel speed, excellent wire feeding
 Excellent arc characteristics give outstanding operator appeal
 Excellent mechanical properties (CNV >47) at -40°C
 Superior product consistency with optimal alloy control
 Depending on application good alternative for basic flux cored wires

WELDING POSITIONS (ISO/ASME)

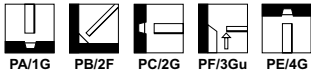

CURRENT TYPE / SHIELDING GAS (ISO 14175)

DC +
 M21 : Mixed gas Ar+ (>15-25%) CO₂
 Flow rate: 15-25 l/min

APPROVALS

Shielding gas	BV	DB	DNV	GL	RINA
M21	SA3,3YMHH	+	IV Y40H5	4Y40H55	4Y5H5

CHEMICAL COMPOSITION (W%), TYPICAL, ALL WELD METAL

Shielding gas	C	Mn	Si	P	S	HDM
M21	0.04	1.5	0.4	0.012	0.020	3 ml/100 g

MECHANICAL PROPERTIES, TYPICAL, ALL WELD METAL

	Shielding gas	Condition	Yield strength [N/mm ²]	Tensile strength [N/mm ²]	Elongation [%]	Impact ISO-V(J)		
						-30°C	-40°C	-50°C
Required: AWS A5.18 EN ISO 17632-A			min. 400 min. 460	min. 480 530-680	min. 22 min. 20		min. 47	
Typical values	M21	AW	480	580	27	120	110	80
	M21	SR	430	485	30		120	90

SR : 2h/640°C

PACKAGING AND AVAILABLE SIZES

Diameter (mm)	1.0	1.2	1.4	1.6
5 kg plastic spool S200	X	X		
15 kg spool B300	X	X	X	X
200 kg Accutrak® Drum	X	X	X	X

Outershield® MC715-H: rev. C-EN28-12/05/16

Outershield® MC715-H

EXAMPLES OF MATERIALS TO BE WELDED

Steel grades/Standard	Type
General structural steels	
EN 10025 part 2	S185, S235, S275, S355
Ship plates	
ASTM A131	Grade A, B, D, AH32 to EH40
Cast steels	
EN 10213-2	G P 240R
Pipe material	
EN 10208-1	L210, L240, L290, L360
EN 10208-2	L240NB, L290NB, L360NB, L360QB, L240MB,
L290MB, L360MB, L415MB, L415NB, L445	
API 5LX	X42, X46, X52, X60, X65
EN 10216-1/	P235T1, P235T2, P275T1
EN 10217-1	P275T2, P355N
Boiler & pressure vessel steels	
EN 10028-2	P235GH, P265GH, P295GH, P355GH
Fine grained steels	
EN 10025 part 3	S275N, S275NL, S355N, S355NL, S420N, S420NL, S460N, S460NL
EN 10025 part 4	S275M, S275ML, S355M, S355ML, S420M, S420ML, S460M, S460ML

CALCULATION DATA

Diameter (mm)	Arc mode	Electrical stick-out (mm)	Wire Feed Speed (cm/min)	Current (A)	Arc Voltage (V)	Deposition rate (kg/h)	kg wire/ kg weldmetal
1.2	Short arc	15	230	100	15	1.1	1.10
			320	120	16	1.4	1.10
			400	150	17	1.9	1.10
1.2	Spray arc	20	635	180	28-30	2.7	1.10
			940	275	31-34	4.8	1.10
			1420	340	35-38	6.8	1.10
			205	105	14.5	1.2	1.10
1.4	Short arc	15	255	125	15.0	1.5	1.10
			280	135	15.5	1.6	1.10
			445	170	27-29	2.5	1.10
1.4	Spray arc	20	890	270	29-32	5.0	1.10
			1400	355	32-34	8.1	1.10
			180	145	15	1.5	1.10
			205	160	16	1.7	1.10
1.6	Short arc	18	230	170	18	1.9	1.10
			380	235	25-26	2.9	1.10
			635	325	29-32	5.0	1.10
1.6	Spray arc	25	890	400	34-37	7.0	1.10
			1145	460	36-38	9.1	1.10

FCAW

WELDING PARAMETERS, OPTIMUM FILL PASSES IN SHIELDING GAS Ar + [±15-25]% CO₂

Diameter (mm)	Welding positions				
	PA/1G	PB/2F	PC/2G	PF/3Gup	PE/4G
1.2	230-380A	230-380A	230-300A	130-170A	140-175A
	26-36V	26-36V	26-30V	15-17V	16-17V
1.4	240-385A	240-385A	240-340A	160-180A	175-185A
	26-36V	26-36V	26-31V	14-15V	15-16V
1.6	280-460A	280-460A	270-300A		
	28-36V	28-36V	28-30V		

Outershield® MC715Ni1-H

CLASSIFICATION

AWS A5.28	E80C-Ni1M H4	A-Nr	10
EN ISO 17632-A	T 46 5 1Ni M M 2 H5	F-Nr	6
		9606 FM	1

GENERAL DESCRIPTION

Gas shielded 1%Ni alloyed metal cored wire for offshore and similar application
 Excellent arc characteristics give outstanding operator appeal
 Virtually no spatter, high travel speed and excellent wire feeding
 Excellent mechanical properties (CVN >47) at -50°C
 Superior product consistency with optimal alloy control
 Ni content is controlled to meet "sour service" oilfield requirements such as NACE MR0175

WELDING POSITIONS (ISO/ASME)



CURRENT TYPE / SHIELDING GAS (ISO 14175)

DC +
 M21 : Mixed gas Ar+ (>15-25%) CO₂
 Flow rate: 15-25 l/min

CHEMICAL COMPOSITION (W%), TYPICAL, ALL WELD METAL

Shielding gas	C	Mn	Si	P	S	Ni	HDM
M21	0.05	1.35	0.45	0.020	0.020	0.95	3 ml/100 g

MECHANICAL PROPERTIES, TYPICAL, ALL WELD METAL

	Shielding gas	Condition	Yield strength [N/mm ²]	Tensile strength [N/mm ²]	Elongation [%]	Impact ISO-V[J]		
						-40°C	-50°C	-60°C
Required: AWS A5.28			min. 470	min. 550	min. 24	min. 27		
EN ISO 17632-A			min. 460	530-680	min. 20		min. 47	
Typical values	M21	AW	530	600	25	100	80	60

PACKAGING AND AVAILABLE SIZES

Diameter (mm)	1.2	1.6
14 kg 5300 (alu bag)	X	X
15 kg spool B300	X	

Outershield® MC715Ni1-H; rev. C-EN04-01/02/16

Outershield® MC715Ni1-H

EXAMPLES OF MATERIALS TO BE WELDED

Steel grades/Standard	Type
General structural steels	
EN 10025 part 2	S185, S235, S275, S355, S460
Ship plates	
ASTM A131	Grade A, B, D, AH32 to EH40
Cast steels	
EN 10213-2	G P 240R
Pipe material	
EN 10208-1	L210, L240, L290, L360
EN 10208-2	L240NB, L290NB, L360NB, L360QB, L240MB, L290MB, L360MB, L415MB, L415NB
API 5LX	X42, X46, X52, X60, X65
EN 10216-1	P235T1, P235T2, P275T1
EN 10217-1	P275T2, P355N
Boiler & pressure vessel steels	
EN 10028-2	P235GH, P265GH, P295GH, P355GH
Fine grained steels	
EN 10025 part 3	S275N, S275NL, S355N, S355NL, S420N, S420NL, S460N, S460NL
EN 10025 part 4	S275M, S275ML, S355M, S355ML, S420M, S420ML, S460M, S460ML

CALCULATION DATA

Diameter (mm)	Arc mode	Electrical stick-out (mm)	Wire Feed		Current [A]	Arc Voltage [V]	Deposition rate (kg/h)	kg wire/kg weldmetal
			Speed (cm/min)					
1.2	Short arc	15	230		100	15	1.1	1.10
			320		120	16	1.4	1.10
			400		150	17	1.9	1.10
1.2	Spray arc	20	635		180	28-30	2.7	1.10
			940		275	31-34	4.8	1.10
			1420		340	35-38	6.8	1.10
1.6	Short arc	18	180		145	15	1.5	1.10
			205		160	16	1.7	1.10
			230		170	18	1.9	1.10
1.6	Spray arc	25	380		235	25-26	2.9	1.10
			635		325	29-32	5.0	1.10
			890		400	34-37	7.0	1.10
			1145		460	36-38	9.1	1.10

FCAW

WELDING PARAMETERS, OPTIMUM FILL PASSES IN SHIELDING GAS Ar + (>15-25)% CO₂

Diameter (mm)	Welding positions				
	PA/1G	PB/2F	PC/2G	PF/3Gup	PE/4G
1.2	230-380A	230-380A	230-300A	130-170A	140-175A
	26-36V	26-36V	26-30V	15-17V	16-17V
1.6	280-460A		270-300A		
	28-36V		28-30V		

Outershield® MC420N-H

CLASSIFICATION

AWS A5.28	E70C-GM H4	A-Nr	10
EN ISO 17632-A	T 38 Z Z M M 2 H5	F-Nr	6
		9606 FM	1

Note: the above mentioned classifications are an indication of the weld metal properties in the as welded condition. However, the Outershield MC420N-H is designed to be used only in the normalized condition. As neither AWS nor EN has included weld metal properties in the normalized condition, the wire cannot be classified for the condition it is designed for.

GENERAL DESCRIPTION

All position high efficiency mix gas shielded metal cored wire
 Excellent arc characteristics, few silicates and virtually no spatter, excellent wire feeding
 High resistance to porosity
 Designed to withstand normalizing treatment (4h 900°C)
 Mechanical properties after normalizing meet base material requirements
 Only to be used in normalized condition!

WELDING POSITIONS (ISO/ASME)

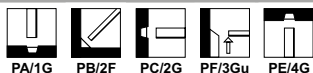

CURRENT TYPE / SHIELDING GAS (ISO 14175)

DC +
 M21 : Mixed gas Ar+ (>15-25%) CO₂
 Flow rate: 15-25 l/min

CHEMICAL COMPOSITION (W%), TYPICAL, ALL WELD METAL

Shielding gas	C	Mn	Si	P	S	Cr	Ni	HDM
M21	0.03	0.6	0.45	0.017	0.023	0.03	2.9	3 ml/100 g

MECHANICAL PROPERTIES, TYPICAL, ALL WELD METAL

	Shielding gas	Condition	Yield strength (N/mm ²)	Tensile strength (N/mm ²)	Elongation (%)	Impact ISO-V(J) -50°C
Typical values	M21	N	353	493	32	57

N = 900°C/4h

PACKAGING AND AVAILABLE SIZES

Diameter (mm)	1.6
15 kg spool B300	X
200 kg Accutrak® Drum	X

Outershield® MC420N-H: rev. C-EN27-01/02/16

All information in this data sheet is accurate to the best of our knowledge at the time of printing. Please refer to www.lincolnelectric.eu for any updated information.
 Fumes: Safety Data Sheets (SDS) are available on our website.

Outershield® MC420N-H

EXAMPLES OF MATERIALS TO BE WELDED

Steel grades/Standard	Type
General structural steels	
EN 10025 part 2	S185, S235, S275, S355
Ship plates	
ASTM A131	Grade A, B, D, AH32 to EH36
Boiler & pressure vessel steels	
EN 10028-2	P235GH, P265GH, P295GH, P355GH
EN 10028-3	P275N, P355N
Fine grained steels	
EN 10025 part 3	S275N, S275NL, S355N, S355NL

The wire is only applicable for materials that will be normalized after welding

CALCULATION DATA

Diameter (mm)	Arc mode	Electrical stick-out (mm)	Wire Feed Speed (cm/min)	Current (A)	Arc Voltage (V)	Deposition rate (kg/h)	kg wire/ kg weldmetal
1.2	Spray arc	20	635	180	28-30	2.7	1.10
			940	275	31-34	4.8	1.10
			1420	340	35-38	6.8	1.10
1.6	Spray arc	25	380	235	25-26	2.9	1.10
			635	325	29-32	5.0	1.10
			890	400	34-37	7.0	1.10
			1145	460	36-38	9.1	1.10

WELDING PARAMETERS, OPTIMUM FILL PASSES IN SHIELDING GAS Ar + [>15-25]% CO₂

Diameter (mm)	Welding positions				
	PA/1G	PB/2F	PC/2G	PF/3Gup	PE/4G
1.2	230-380A	230-380A	230-300A	130-170A	140-175A
	26-36V	26-36V	26-30V	15-17V	16-17V

Outershield® MC460VD-H

CLASSIFICATION

AWS A5.18	E70C-6M H4	A-Nr	10
EN ISO 17632-A	T 46 2 M M1 H5	F-Nr	6
		9606 FM	1

GENERAL DESCRIPTION

Metal cored wire for fillet welding with high efficiency
 Especially for vertical down welding in thin plate
 Excellent arc characteristics give outstanding operator appeal
 No slag, only some silicate islands, very good wire feeding
 High resistance to porosity on primed plate
 Superior product consistency with optimal alloy control

WELDING POSITIONS (ISO/ASME)



PA/1G



PB/2F



PC/2G



PF/3Gu



PG/3Gd



PE/4G

CURRENT TYPE / SHIELDING GAS (ISO 14175)

DC -
 M21 : Mixed gas Ar+ (>15-25%) CO₂
 Flow rate: 15-25 l/min

APPROVALS

Shielding gas	ABS	BV	DNV	GL	LR
M21	3YSA,H5	SA3YMH5H	IIIMSH5	3YH5S	3S,3YSH5

CHEMICAL COMPOSITION (W%), TYPICAL, ALL WELD METAL

Shielding gas	C	Mn	Si	P	S	HDM
M21	0.05	1.25	0.6	0.015	0.015	3 ml/100 g

MECHANICAL PROPERTIES, TYPICAL, ALL WELD METAL

	Shielding gas	Condition	Yield strength [N/mm ²]	Tensile strength [N/mm ²]	Elongation [%]	Impact ISO-V(J)	
						-20°C	-29°C
Required: AWS A5.18			min. 400	min. 480	min. 22		min. 27
EN ISO 17632-A			min. 460	530-680	min. 20		min. 47
Typical values	M21	AW	510	600	25	90	60

PACKAGING AND AVAILABLE SIZES

Diameter (mm)	1.2
15 kg spool B300	X

Outershield® MC640VD-H; rev. C-EN25-01/02/16

Outershield® MC460VD-H

EXAMPLES OF MATERIALS TO BE WELDED

Steel grades/Standard	Type
General structural steels	
EN 10025 part 2	S185, S235, S275, S355
Ship plates	
ASTM A131	Grade A, B, D, AH32 to EH40
Cast steels	
EN 10213-2	G P 240R
Pipe material	
EN 10208-1	L210, L240, L290, L360
EN 10208-2	L240NB, L290NB, L360NB, L360QB, L240MB, L290MB, L360MB, L415MB, L415NB, L445
API 5LX	X42, X46, X52, X60
EN 10216-1/	P235T1, P235T2, P275T1
EN 10217-1	P275T2, P355N
Boiler & pressure vessel steels	
EN 10028-2	P235GH, P265GH, P295GH, P355GH
Fine grained steels	
EN 10025 part 3	S275N, S355N, S420N
EN 10025 part 4	S275M, S275ML, S355M, S355ML, S420M, S420ML

CALCULATION DATA

Diameter (mm)	Electrical stick-out (mm)	Wire Feed Speed (cm/min)	Current (A)	Arc Voltage (V)	Deposition rate (kg/h)	kg wire/ kg weldmetal
1.2	20	635	180	28-30	2.7	1.10
		940	275	31-34	4.8	1.10
		1420	340	35-38	6.8	1.10

WELDING PARAMETERS, OPTIMUM FILL PASSES IN SHIELDING GAS Ar + [≥15-25]% CO₂

Diameter (mm)	Welding positions			
	PB/2F	PC/2G	PF/3Gup	PE/4G
1.2	250-300A	250-300A	200-220A	200-220A
	26-30V	26-30V	21-24V	23-25V

Outershield® 70-H

CLASSIFICATION

AWS A5.20	E70T-1C-H4 / E70T-1M-H4	A-Nr	1
EN ISO 17632-A	T 46 0 R C 3 H5 / T 46 0 R M 3 H5	F-Nr	6
		9606 FM	1

GENERAL DESCRIPTION

Gas shielded flux cored wire for semi-automatic or mechanized downhand welds
 Low spatter, good slag removal, smooth appearance, excellent operator appeal
 High deposition rate and deep penetration, good resistance to scale and rust
 Reliable weld metal properties
 Excellent wire feeding
 Superior product consistency with optimal alloy control

WELDING POSITIONS (ISO/ASME)



PA/1G PB/2F PC/2G

CURRENT TYPE / SHIELDING GAS (ISO 14175)

DC +
 M21 : Mixed gas Ar+ (>15-25%) CO₂
 C1 : Active gas 100% CO₂
 Flow rate: 15-25 l/min

APPROVALS

Shielding gas	DB
M21	+
C1	+

CHEMICAL COMPOSITION (W%), TYPICAL, ALL WELD METAL

Shielding gas	C	Mn	Si	P	S	HDM
M21	0.06	1.70	0.35	0.015	0.010	< 5 ml/100 g
C1	0.06	1.30	0.50	0.015	0.010	< 5 ml/100 g

MECHANICAL PROPERTIES, TYPICAL, ALL WELD METAL

	Shielding gas	Condition	Yield strength (N/mm ²)	Tensile strength (N/mm ²)	Elongation (%)	Impact ISO-V(J)		
						0°C	-18°C	-30°C
Required: AWS A5.20 EN ISO 17632-A			min. 400 min. 460	min. 480 530-680	min. 22 min. 20	min. 47	min. 27	
Typical values	C1 M21	AW AW	480 530	560 610	26 27	80 70	50 40	

PACKAGING AND AVAILABLE SIZES

Diameter (mm)	2.4
25 kg wire reel B435	X
270 kg wooden reel	X

Outershield® 70-H: rev. C-EN24-01/02/16

Outershield® 70-H

EXAMPLES OF MATERIALS TO BE WELDED

Steel grades/Standard	Type
General structural steels	
EN 10025 part 2	S185, S235, S275, S355
Ship plates	
ASTM A131	Grade A, B, D, AH32 to DH36
Cast steels	
EN 10213-2	G P 240R
Pipe material	
EN 10208-1	L210, L240, L290, L360
EN 10208-2	L240NB, L290NB, L360NB, L360QB, L240MB, L290MB, L360MB, L415MB, L415NB
API 5LX	X42, X46, X52, X60
EN 10216-1/	P235T1, P235T2, P275T1
EN 10217-1	P275T2, P355N
Boiler & pressure vessel steels	
EN 10028-2	P235GH, P265GH, P295GH, P355GH
Fine grained steels	
EN 10025 part 3	S275, S355, S420
EN 10025 part 4	S275M, S275ML, S355M, S355ML, S420M, S420ML

CALCULATION DATA

Diameter (mm)	Electrical stick-out (mm)	Wire Feed Speed (cm/min)	Current (A)	Arc Voltage (V)	Deposition rate (kg/h)	kg wire/ kg weldmetal
2.4	28	320	340	24-27	4.5	1.15
		510	450	28-31	7.3	1.15
		635	510	30-32	9.1	1.15
		700	535	31-34	10.0	1.15
		825	585	33-35	11.8	1.15

WELDING PARAMETERS, OPTIMUM FILL PASSES IN SHIELDING GAS 100% CO₂

Diameter (mm)	Welding positions	
	PA/1G	PB/2F
2.4	410-560A	410-510A
	27-34V	28-32V

FCAW

Outershield® 71E-H

CLASSIFICATION

AWS A5.20	E71T-1M-JH4 / E71T-1C-H4	A-Nr	1
EN ISO 17632-A	T 46 3 P M 1 H5 / T 42 0 P C 1 H5	F-Nr	6
		9606 FM	1

GENERAL DESCRIPTION

All position gas shielded flux cored wire for high quality welding
 Excellent operator appeal due to superior welding characteristics
 Full out-of-position capability with higher deposition rates
 Exceptional mechanical properties (CVN > 47) at -30°C with M21 shielding gas)
 Superior product consistency with optimal alloy control
 Excellent wire feeding
 Very suitable for welding of root runs on ceramic backing
 Designed for use with M21 Ar+15-25%CO₂ shielding gas. Suitable for use with C1 100%CO₂

2

WELDING POSITIONS (ISO/ASME)

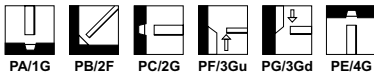

CURRENT TYPE / SHIELDING GAS (ISO 14175)

DC +
 M21 : Mixed gas Ar+ (>15-25%) CO₂
 C1 : Active gas 100% CO₂
 Flow rate: 15-25 l/min

APPROVALS

Shielding gas	ABS	BV	DB	DNV	GL	LR	RINA	RMRS	TÜV
M21	3YSAH5	SA3YMH5	+	IIYMS(H5)	3YH5S	3YSH5	3YSH5	3YSH5	+
C1	2YSA H5			IIYMS(H5)		2YS H5			

CHEMICAL COMPOSITION (W%), TYPICAL, ALL WELD METAL

Shielding gas	C	Mn	Si	P	S	HDM
M21	0.04	1.4	0.6	0.013	0.010	3 ml/100 g
C1	0.05	1.3	0.6	0.015	0.010	3 ml/100 g

MECHANICAL PROPERTIES, TYPICAL, ALL WELD METAL

	Shielding gas	Condition	Yield strength (N/mm ²)	Tensile strength (N/mm ²)	Elongation (%)	Impact ISO-V(J)			
						0°C	-20°C	-30°C	-40°C
Required: AWS A5.20 EN ISO 17632-A			min. 400 min. 460	min. 480 530-680	min. 22 min. 20			min. 47	min. 27
Typical values	M21 C1	AW AW	570 520	620 575	25 24	80	90	65	40

PACKAGING AND AVAILABLE SIZES

Diameter (mm)	1.2	1.6
5 kg plastic spool S200	X	
15 kg spool B300	X	X
15 kg spool S300	X	X
200kg Accutrak® Drum	X	

Outershield® 71E-H rev. C-EN31-01/02/16

All information in this data sheet is accurate to the best of our knowledge at the time of printing. Please refer to www.lincolnelectric.eu for any updated information.
 Fumes: Safety Data Sheets (SDS) are available on our website.

Outershield® 71E-H

EXAMPLES OF MATERIALS TO BE WELDED

Steel grades/Standard	Type
General structural steels	
EN 10025 part 2	S185, S235, S275
Ship plates	
ASTM A131	Grade A, B, D, AH32 to EH36
Cast steels	
EN 10213-2	G P 240R
Pipe material	
API 5LX	X42, X46, X52, X60, X65
ISO 3183	X42 - X60; L245-L415N, L245-L450Q, L245M - L450M
EN 10216-1	P235T1, P235T2, P275T1
EN 10217-1	P275T2, P355N
Boiler & pressure vessel steels	
EN 10028-2	P235-355 GH
EN 10028-3	P235-460 N, NH
Fine grained steels	
EN 10025 part 3	S275, S355, S420, S460
EN 10025 part 4	S275M, S275ML, S355M, S355ML, S420M, S420ML

CALCULATION DATA

Diameter (mm)	Electrical stick-out (mm)	Wire Feed Speed (cm/min)	Current (A)	Arc Voltage (V)	Deposition rate (kg/h)	kg wire/kg weldmetal
1.2	20	445	130	20-22	1.6	1.20
		700	180	23-25	2.3	1.20
		950	220	25-27	3.2	1.20
		1270	265	27-29	4.3	1.20
		1590	305	30-32	5.4	1.20
1.6	20	320	160	20-22	2.2	1.20
		510	230	21-24	3.3	1.20
		635	280	23-25	4.2	1.20
		760	300	24-26	5.0	1.20
		890	340	26-28	5.8	1.20
		1015	360	27-29	6.5	1.20
		1080	390	28-30	7.0	1.20

WELDING PARAMETERS, OPTIMUM FILL PASSES IN SHIELDING GAS Ar + [15-25]% CO₂

Diameter (mm)	Welding positions					
	PA/1G	PB/2F	PC/2G	PF/3Gup	PG/3Gdown	PE/4G
1.2	230-260A	230-260A	200-240A	200-240A	160-220A	160-220A
	26-32V	26-32V	25-30V	25-28V	23-26V	26-28V

Outershield® 71M-H

CLASSIFICATION

AWS A5.20	E71T-1/9C-H4 / E71T-1/9M-H4	A-Nr	1
EN ISO 17632-A	T 46 3 P C 1 H5 / T 46 2 P M 2 H5	F-Nr	6
		9606 FM	1

GENERAL DESCRIPTION

Rutile gas shielded flux cored wire for high deposition and quality welding
 Excellent operator appeal due to superior welding characteristics and premium slag system
 Specially developed for welding with 100% CO₂ and optimised for Ar/CO₂ mix gas; smooth arc with low spatter
 Suitable for welding coated plate
 Perfect root pass welding on ceramic backing
 Good mechanical properties (CVN > 47) at -30°C for 100% CO₂
 High current capacity, especially in positional welding
 Stable mechanical properties over the wider range of heat input

WELDING POSITIONS (ISO/ASME)

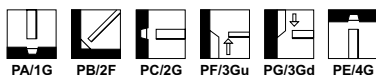

CURRENT TYPE / SHIELDING GAS (ISO 14175)

DC +
 M21 : Ar + (15-25%) CO₂
 C1 : Active gas 100% CO₂
 Flow rate : 15-25 l/min

APPROVALS

Shielding gas	ABS	BV	DNV	GL	LR	RINA	PRS
C1	3YSAH5	SA3YMH5	3YH5S	IIYMS(H5)	3YH5S	3YSH5	3YSH5
M21	3Y40SAH5	SA3Y40MH5	3Y40H5S	IIY40MS(H5)	3Y40MS(H5)	3Y40SH5	3Y40SMH5

CHEMICAL COMPOSITION (W%), TYPICAL, ALL WELD METAL

Shielding gas	C	Mn	Si	P	S	HDM
C1	0.05	1,3	0.4	0.015	0.009	3 ml/100 g
M21	0.05	1,47	0.5	0.015	0.009	4 ml/100 g

MECHANICAL PROPERTIES, TYPICAL, ALL WELD METAL

	Shielding gas	Condition	Yield strength (N/mm ²)	Tensile strength (N/mm ²)	Elongation (%)	Impact ISO-V(J)	
						-20°C	-30°C
Required: AWS A5.20 EN ISO 17632-A			min. 400 min. 460	min. 480 530-680	min. 22 min. 20	min. 47	min. 47
Typical values	C1	AW	530	590	25		70
	M21	AW	595	650	26	80	

PACKAGING AND AVAILABLE SIZES

Diameter (mm)	1.2	1.6
5 kg spool S200	X	
15 kg spool B300	X	X
15 kg spool S300	X	X

Outershield® 71M-H rev. C-EN30-1/05/16

Outershield® 71M-H

EXAMPLES OF MATERIALS TO BE WELDED

Steel grades/Standard	Type
General structural steels	
EN 10025	S185, S235, S275
Ship plates	
ASTM A131	Grade A, B, D, AH32 to EH36
Cast steels	
EN 10213-2	G P 240R
Pipe material	
EN 10208-1	L210, L240, L290, L360
EN 10208-2	L240NB, L290NB, L360NB, L360QB, L240MB, L290MB, L360MB, L415MB, L415NB
API 5LX	X42, X46, X52, X60
EN 10216-1/	P235T1, P235T2, P275T1
EN 10217-1	P275T2, P355N
Boiler & pressure vessel steels	
EN 10028-2	P235GH, P265GH, P295GH, P355GH
Fine grained steels	
EN 10025 part 3	S275, S355, S420, S460
EN 10025 part 4	S275M, S275ML, S355M, S355ML, S420M, S420ML

CALCULATION DATA, C1 AND M21 SHIELDING GASES

Diameter (mm)	Electrical stick-out (mm)	Wire Feed Speed (cm/min)	Current (A)	Arc Voltage (V)	Deposition rate (kg/h)	kg wire/kg weldmetal
1.2	20	445	130	21-23	1,75	1.16
		700	170	22-24	2,54	1.16
		955	220	25-27	3,45	1.16
		1270	260	27-29	4,73	1.16
		1590	290	30-32	6,2	1.16
1.6	20	320	180	21-23	2,2	1.16
		510	255	22-25	3,3	1.16
		635	300	24-26	4,2	1.16
		760	335	25-27	5,0	1.16
		890	370	27-29	5,8	1.16
		1015	395	28-30	6,5	1.16
		1080	415	29-30	7,0	1.16

WELDING PARAMETERS, OPTIMUM FILL PASSES IN C1 AND M21 SHIELDING GASES

Diameter (mm)	Welding positions					
	PA/1G	PB/2F	PC/2G	PF/3Gup	PG/3Gdown	PE/4G
1.2	230-280A	230-280A	200-240A	200-240A	160-220A	160-220A
	26-32V	26-32V	25-30V	25-28V	23-26V	26-28V
1.6	250-380A	250-380A	230-280A	220-260A	170-240A	170-240A
	24-32V	24-32V	24-30V	22-28V	22-28V	22-28V

Outershield® 71MS-H

CLASSIFICATION

AWS A5.20	E71T-9C-JH4	A-Nr	1
EN ISO 17632-A	T 46 4 P C 2 H5	F-Nr	6
		9606 FM	1

GENERAL DESCRIPTION

Rutile gas shielded flux cored wire for high deposition and quality welding
 Superior arc direction and welding characteristics
 Perfect root pass welding on ceramic backing
 Outstanding mechanical properties (CVN > 47) at -40°C
 High current capacity, especially in out of position welding
 Stable mechanical properties over the wider range of heat input

WELDING POSITIONS (ISO/ASME)



CURRENT TYPE / SHIELDING GAS (ISO 14175)

DC +
 C1 : Active gas 100% CO₂
 Flow rate: 15-25 l/min

APPROVALS

Shielding gas	ABS	DNV
C1	4YSA H5	IVY40MS(H5)

CHEMICAL COMPOSITION (W%), TYPICAL, ALL WELD METAL

Shielding gas	C	Mn	Ni	Si	P	S	HDM
C1	0.05	1.35	0.4	0.4	0.015	0.010	3 ml/100 g

MECHANICAL PROPERTIES, TYPICAL, ALL WELD METAL

	Shielding gas	Condition	Yield strength (N/mm ²)	Tensile strength (N/mm ²)	Elongation (%)	Impact ISO-V(J)
						-40°C
Required: AWS A5.20			min. 400	min. 480	min. 22	
EN ISO 17632-A			min. 460	530-680	min. 20	min. 47
Typical values	C1	AW	540	610	25	75

PACKAGING AND AVAILABLE SIZES

Diameter (mm)	1.2	1.6
5 kg spool S200	X	
15 kg spool B300	X	X
15 kg spool S300	X	X

Outershield® 71MS-H rev. C-EN06-19/04/16

Outershield® 71MS-H

EXAMPLES OF MATERIALS TO BE WELDED

Steel grades/Standard	Type
General structural steels	
EN10027-1	S235 - S460; J2, K2, N and NL, M and ML
Ship plates	
ASTM, ABS, DNV	Grade A, D, EH32 to 40; NV A,D,E 32-40; NV A,D,E 420-460
Pipe material	
ISO 3183	L210, L240, L290, L360
API 5LX	X42, X46, X52, X60, X65
Boiler & pressure vessel steels	
EN 10028-2	P235-355GH
EN 10028-3	P235-460, N, NH, NL
Fine grained steels	
EN 10025 -2, -3, -4	S235, S275; S355, S420, S420, S460, S460, S460, S460 N, NL, M, ML
EN 10025	S355G, S420G grades
EN 10025-6	S460Q, QL

CALCULATION DATA

Diameter (mm)	Electrical stick-out (mm)	Wire Feed Speed (cm/min)	Current (A)	Arc Voltage (V)	Deposition rate (kg/h)	kg wire/kg weldmetal
1.2	20	445	130	21-23	1.75	1.16
		700	170	22-24	2.54	1.16
		955	220	25-27	3.45	1.16
		1270	260	27-29	4.73	1.16
		1590	290	30-32	6.2	1.16

WELDING PARAMETERS, OPTIMUM FILL PASSES IN CO₂ SHIELDING GAS

Diameter (mm)	Welding positions				
	PA/1G	PB/2F	PC/2G	PF/3Gup	PE/4G
1.2	160-280A	160-280A	160-230A	200-240A	150-220A
	24-32V	24-32V	24-30V	24-27V	23-28V

FCAW

Outershield® T55-H

CLASSIFICATION

AWS A5.20	E71T-5C-JH4 / E71T-5M-JH4	A-Nr	1
EN ISO 17632-A	T 42 4 B C 2 H5 / T 42 4 B M 2 H5	F-Nr	6
		9606 FM	1

GENERAL DESCRIPTION

All position gas shielded basic flux cored wire
 Good weldability, also vertical up [3G]
 Exceptional mechanical properties (CVN >47J at -50°C)
 Superior product consistency with optimal alloy control
 Excellent wire feeding

WELDING POSITIONS (ISO/ASME)

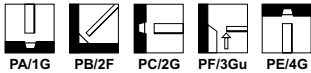

CURRENT TYPE / SHIELDING GAS (ISO 14175)

DC -
 M21 : Mixed gas Ar+ (>15-25%) CO₂
 C1 : Active gas 100% CO₂
 Flow rate: 15-25 l/min

APPROVALS

Shielding gas	ABS	BV	DB	DNV	GL	LR	RINA
M21	3SA,3YSA	SA3,3YMHH	+	IVYMSH5	4YH10S	4Y40SH15	
C1	3SA,3YSA	SA3,3YMHH	+	IVYMSH5	4YH10S	4Y40SH15	3YS

CHEMICAL COMPOSITION (W%), TYPICAL, ALL WELD METAL

Shielding gas	C	Mn	Si	P	S	HDM
C1	0.05	1.5	0.55	0.012	0.010	3 ml/100 g
M21	0.06	1.5	0.6	0.012	0.010	3 ml/100 g

MECHANICAL PROPERTIES, TYPICAL, ALL WELD METAL

	Shielding gas	Condition	Yield strength [N/mm ²]	Tensile strength [N/mm ²]	Elongation [%]	Impact ISO-V(J)		
						-20°C	-40°C	-50°C
Required: AWS A5.20 EN ISO 17632-A			min. 400 min. 420	min. 480 500-640	min. 22 min. 20		min. 27 min. 47	
Typical values	M21	AW SR	480 425	570 550	27 27	130	85 80	60

SR : 15h/580°C

PACKAGING AND AVAILABLE SIZES

Diameter (mm)	1.2	1.6
15 kg spool B300	X	X

Outershield® T55-H: rev. C-EN28-01/02/16

Outershield® T55-H

EXAMPLES OF MATERIALS TO BE WELDED

Steel grades/Standard	Type
General structural steels	
EN 10025	S185, S235, S275, S355
Ship plates	
ASTM A131	Grade A, B, D, AH32 to EH40
Cast steels	
EN 10213-2	G P 240R
Pipe material	
EN 10208-1	L210, L240, L290, L360
EN 10208-2	L240NB, L290NB, L360NB, L360QB, L240MB, L290MB, L360MB, L415MB, L415NB
API 5LX	X42, X46, X52, X60
EN 10216-1/	P235T1, P235T2, P275T1
EN 10217-1	P275T2, P355N
Boiler & pressure vessel steels	
EN 10028-2	P235GH, P265GH, P295GH, P355GH
Fine grained steels	
EN 10025 part 3	S275, S355, S420
EN 10025 part 4	S275M, S275ML, S355M, S355ML, S420M, S420ML

CALCULATION DATA

Diameter (mm)	Electrical stick-out (mm)	Wire Feed Speed (cm/min)	Current (A)	Arc Voltage (V)	Deposition rate (kg/h)	kg wire/kg weldmetal
1.2	20	510	130	25-27	1.6	1.20
		760	185	26-28	2.5	1.20
		1015	225	27-29	3.3	1.20
		1270	260	28-30	4.1	1.20
		1525	290	29-31	5.0	1.20
		1780	310	30-32	5.8	1.20
1.6	20	380	170	24-26	2.5	1.15
		510	225	25-27	3.1	1.15
		760	310	27-29	4.7	1.15
		1015	380	29-31	6.3	1.15
		1270	430	31-33	7.9	1.15

WELDING PARAMETERS, OPTIMUM FILL PASSES IN SHIELDING GAS Ar + [>15-25]% CO₂

Diameter (mm)	Welding positions			
	PA/1G	PB/2F	PC/2G	PF/3Gup
1.2	215-290A	215-290A	215-250A	110-150A
	28-34V	28-34V	28-30V	17-20V
1.6	320-390A	320-390A	280-350A	130-180A
	28-34V	28-34V	28-32V	18-22V
2.4	350-550A	350-550A		
	30-34V	30-34V		

Outershield® 81Ni1-H

CLASSIFICATION

AWS A5.29	E81T1-Ni1M-JH4 (all diameters)	A-Nr	10
EN ISO 17632-A	T 50 51Ni P M 2 H5 (only diameter 1.2 mm)	F-Nr	6
		9606 FM	2

GENERAL DESCRIPTION

All position gas shielded 1% Ni flux cored wire, offshore and similar applications
 Superior weldability, low spatter, good bead appearance
 Outstanding operator appeal
 Exceptional mechanical properties (CVN >47) at -50°C
 Superior product consistency with optimal alloy control
 Excellent wire feeding
 Meets NACE MR-0175 requirements
 For PWHT, use Outershield 81Ni1-HSR

WELDING POSITIONS (ISO/ASME)

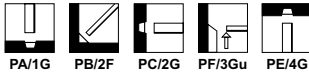

CURRENT TYPE / SHIELDING GAS (ISO 14175)

DC +
 M21 : Mixed gas Ar+ (>15-25%) CO₂
 Flow rate: 15-25 l/min

APPROVALS

Shielding gas	RINA	BV	DNV	GL	LR
M21	4YSH5	SA3,3YMHH	IVYMSH5	4YH10S	4Y40SH5

CHEMICAL COMPOSITION (W%), TYPICAL, ALL WELD METAL

Shielding gas	C	Mn	Si	P	S	Ni	HDM
M21	0.05	1.4	0.2	0.013	0.010	0.95	3 ml/100 g

MECHANICAL PROPERTIES, TYPICAL, ALL WELD METAL

	Shielding gas	Condition	Yield strength (N/mm ²)	Tensile strength (N/mm ²)	Elongation (%)	Impact ISO-V(J)	
						-40°C	-50°C
Required: AWS A5.29 EN ISO 17632-A			min. 470 min. 500	550-690 560-720	min. 19 min. 18	min. 27	min. 47
Typical values	M21	AW	530	600	24	90	60

PACKAGING AND AVAILABLE SIZES

Diameter (mm)	1.0	1.2	1.4	1.6	2.0
4.5 kg plastic spool S200	X	X			
14 kg S300 (alu bag)	X	X	X	X	X
15 kg spool B300		X	X		
15 kg spool B5300		X			

Outershield® 81Ni1-H; rev. C-EN29-19/04/16

Outershield® 81Ni1-H

EXAMPLES OF MATERIALS TO BE WELDED

Steel grades/Standard	Type
General structural steels	
EN 10025 part 2	S185, S235, S275, S355
Ship plates	
ASTM A131	Grade A, B, D, AH32 to EH40
Cast steels	
EN 10213-2	G P 240R
Pipe material	
EN 10208-1	L210, L240, L290, L360
EN 10208-2	L240NB, L290NB, L360NB, L360QB, L240MB, L290MB, L360MB, L415MB, L415NB
API 5LX	X42, X46, X52, X60, X65, X70
EN 10216-1/	P235T1, P235T2, P275T1
EN 10217-1	P275T2, P355N
Boiler & pressure vessel steels	
EN 10028-2	P235GH, P265GH, P295GH, P355GH
Fine grained steels	
EN 10025 part 3	S275N, S275NL, S355N, S355NL, S420N, S420NL, S460N, S460NL
EN 10025 part 4	S275M, S275ML, S355M, S355ML, S420M, S420ML, S460M, S460ML

CALCULATION DATA

Diameter (mm)	Electrical stick-out (mm)	Wire Feed Speed (cm/min)	Current [A]	Arc Voltage [V]	Deposition rate (kg/h)	kg wire/kg weldmetal
1.2	20	445	130	20-22	1.6	1.20
		700	180	23-25	2.5	1.20
		950	220	25-27	3.4	1.20
		1270	265	27-29	4.5	1.20
		1590	305	30-32	5.9	1.20
1.6	20	320	170	21-23	1.9	1.20
		510	235	22-24	3.1	1.20
		635	275	24-25	3.9	1.20
		760	310	25-27	4.7	1.20
		890	350	27-29	5.6	1.20
		1015	385	28-30	6.4	1.20
		1080	400	30-31	6.8	1.20

WELDING PARAMETERS, OPTIMUM FILL PASSES IN SHIELDING GAS Ar + [\geq 15-25]% CO₂

Diameter (mm)	Welding positions				
	PA/1G	PB/2F	PC/2G	PF/3Gup	PE/4G
1.2	230-280A	230-280A	200-240A	200-240A	160-220A
	26-32V	26-32V	25-32V	25-28V	23-28V
1.6	250-350A	250-350A	230-280A	220-260A	170-240A
	24-32V	24-32V	24-32V	24-28V	22-28V

FCAW

Outershield® 81Ni1-HSR

CLASSIFICATION

AWS A5.29	E81T1-Ni1M-JH4	A-Nr	10
EN ISO 17632-A	T 50 5 1Ni P M 2 H5 T	F-Nr	6
		9606 FM	2

GENERAL DESCRIPTION

All position gas shielded 1% Ni flux cored wire, offshore and similar applications
 Specific design for stress relieved applications, guaranteed impact properties after PWHT
 Superior weldability, low spatter, good bead appearance
 Outstanding operator appeal
 Exceptional mechanical properties (CVN >47J at -50°C)
 Superior product consistency with optimal alloy control
 Excellent wire feeding
 Meets NACE MR-0175 requirements

WELDING POSITIONS (ISO/ASME)



CURRENT TYPE / SHIELDING GAS (ISO 14175)

DC +
 M21 : Mixed gas Ar+ (>15-25%) CO₂
 Flow rate: 15-25 l/min

APPROVALS

Shielding gas	BV	DNV	GL	LR
M21	4YSDH5	IVYMSH5	4YH5S	4YSH5

CHEMICAL COMPOSITION (W%), TYPICAL, ALL WELD METAL

Shielding gas	C	Mn	Si	P	S	Ni	HDM
M21	0.05	1.4	0.2	0.013	0.010	0.95	3 ml/100 g

MECHANICAL PROPERTIES, TYPICAL, ALL WELD METAL

	Shielding gas	Condition	Yield strength (N/mm ²)	Tensile strength (N/mm ²)	Elongation (%)	Impact ISO-V(J)	
						-40°C	-50°C
Required: AWS A5.29			min. 470	550-690	min. 19	min. 27	
EN ISO 17632-A			min. 500	560-720	min. 18	min. 47	
Typical values	M21	AW	530	600	24	90	60
		SR	525	590	25		70

SR 1h/600°C, 3G up - V45°

PACKAGING AND AVAILABLE SIZES

Diameter (mm)	1.2	1.6
14 kg S300 (alu bag)	X	X
15 kg spool B300	X	

Outershield® 81Ni1-HSR: rev. C-EN27-12/05/16

All information in this data sheet is accurate to the best of our knowledge at the time of printing. Please refer to www.lincolnelectric.eu for any updated information.
 Fumes: Safety Data Sheets (SDS) are available on our website.

Outershield® 81Ni1-HSR

EXAMPLES OF MATERIALS TO BE WELDED

Steel grades/Standard	Type
General structural steels	
EN 10025 part 2	S185, S235, S275, S355
Ship plates	
ASTM A131	Grade A, B, C, D, AH32 to DH36
Cast steels	
EN 10213-2	G P 240R
Pipe material	
EN 10208-1	L210, L240, L290, L360
EN 10208-2	L240NB, L290NB, L360NB, L360QB, L240MB, L290MB, L360MB, L415MB, L415NB
API 5LX	X42, X46, X52, X60, X65, X70
EN 10216-1/	P235T1, P235T2, P275T1
EN 10217-1	P275T2, P355N
Boiler & pressure vessel steels	
EN 10028-2	P235GH, P265GH, P295GH, P355GH
Fine grained steels	
EN 10025 part 3	S275N, S275NL, S355N, S355NL, S420N, S420NL, S460N, S460NL
EN 10025 part 4	S275M, S275ML, S355M, S355ML, S420M, S420ML, S460M, S460ML S460ML

CALCULATION DATA

Diameter (mm)	Electrical stick-out (mm)	Wire Feed Speed (cm/min)	Current (A)	Arc Voltage (V)	Deposition rate (kg/h)	kg wire/kg weldmetal
1.2	20	445	130	20-22	1.6	1.20
		700	180	23-25	2.5	1.20
		950	220	25-27	3.4	1.20
		1270	265	27-29	4.5	1.20
		1590	305	30-32	5.9	1.20
1.6	20	320	170	21-23	1.9	1.20
		510	235	22-24	3.1	1.20
		635	275	24-25	3.9	1.20
		760	310	25-27	4.7	1.20
		890	350	27-29	5.6	1.20
		1015	385	28-30	6.4	1.20
		1080	400	30-31	6.8	1.20

WELDING PARAMETERS, OPTIMUM FILL PASSES IN SHIELDING GAS Ar + [15-25]% CO₂

Diameter (mm)	Welding positions				
	PA/1G	PB/2F	PC/2G	PF/3Gup	PE/4G
1.2	230-280A	230-280A	200-240A	200-240A	160-220A
	26-32V	26-32V	25-32V	25-28V	23-28V
1.6	250-350A	250-350A	230-280A	220-260A	170-240A
	24-32V	24-32V	24-32V	24-28V	22-28V

FCAW

Outershield® 81Ni1C-H

CLASSIFICATION

AWS A5.29	E81T1-Ni1C-JH4	A-Nr	10
EN ISO 17632-A	T 50 41Ni P C 2 H5	F-Nr	6
		9606 FM	2

GENERAL DESCRIPTION

All position 100% CO₂ gas shielded 1% Ni flux cored wire, offshore and similar applications
 Superior weldability, low spatter, good bead appearance
 Outstanding operator appeal
 Exceptional mechanical properties [CVN >47] at -40°C
 Superior product consistency with optimal alloy control
 Excellent wire feeding
 Meets NACE MR-0175 requirements

WELDING POSITIONS (ISO/ASME)



PA/1G



PB/2F



PC/2G



PF/3Gu



PG/3Gd



PE/4G

CURRENT TYPE / SHIELDING GAS (ISO 14175)

DC +
 C1 : Active gas 100% CO₂
 Flow rate: 15-25 l/min

CHEMICAL COMPOSITION (W%), TYPICAL, ALL WELD METAL

Shielding gas	C	Mn	Si	P	S	Ni	HDM
C1	0.05	1.4	0.2	0.013	0.010	0.95	4 ml/100 g

MECHANICAL PROPERTIES, TYPICAL, ALL WELD METAL

	Shielding gas	Condition	Yield strength (N/mm ²)	Tensile strength (N/mm ²)	Elongation (%)	Impact ISO-V(J)
						-40°C
Required: AWS A5.29 EN ISO 17632-A			min. 470 min. 500	550-690 560-720	min. 19 min. 18	min. 27 min. 47
Typical values	C1	AW	530	600	24	80

PACKAGING AND AVAILABLE SIZES

Diameter (mm)	1.2
15 kg spool B300	X

Outershield® 81Ni1C-H: rev. C-EN03-01/02/16

Outershield® 81Ni1C-H

EXAMPLES OF MATERIALS TO BE WELDED

Steel grades/Standard	Type
General structural steels	
EN 10025 part 2	S185, S235, S275, S355
Ship plates	
ASTM A131	Grade A, B, D, AH32 to EH40
Cast steels	
EN 10213-2	G P 240R
Pipe material	
EN 10208-1	L210, L240, L290, L360
EN 10208-2	L240NB, L290NB, L360NB, L360QB, L240MB, L290MB, L360MB, L415MB, L415NB
API 5LX	X42, X46, X52, X60
EN 10216-1/	P235T1, P235T2, P275T1
EN 10217-1	P275T2, P355N
Boiler & pressure vessel steels	
EN 10028-2	P235GH, P265GH, P295GH, P355GH
Fine grained steels	
EN 10025 part 3	S275N, S275NL, S355N, S355NL, S420N, S420NL, S460N, S460NL
EN 10025 part 4	S275M, S275ML, S355M, S355ML, S420M, S420ML, S460M, S460ML

CALCULATION DATA

Diameter (mm)	Electrical stick-out (mm)	Wire Feed Speed (cm/min)	Current (A)	Arc Voltage (V)	Deposition rate (kg/h)	kg wire/kg weldmetal
1.2	20	445	130	20-22	1.6	1.20
		700	180	23-25	2.5	1.20
		950	220	25-27	3.4	1.20
		1270	265	27-29	4.5	1.20
		1590	305	30-32	5.9	1.20

WELDING PARAMETERS, OPTIMUM FILL PASSES IN SHIELDING GAS Ar + (>15-25)% CO₂

Diameter (mm)	Welding positions				
	PA/1G	PB/2F	PC/2G	PF/3Gup	PE/4G
1.2	230-280A	230-280A	200-240A	200-240A	160-220A
	26-32V	26-32V	25-32V	25-28V	23-28V

Outershield® 81K2-H

CLASSIFICATION

AWS A5.29	E81T1-K2M-JH4 (all diameters)	A-Nr	10
EN ISO 17632-A	T 50 6 1.5Ni P M 2 H5 (only diameter 1.2 mm)	F-Nr	6
		9606 FM	2

GENERAL DESCRIPTION

All position gas shielded 1.5% Ni, Ti and B alloyed flux cored wire
 Used in off-shore and similar applications
 Superior weldability, low spatter, good bead appearance
 Outstanding operator appeal
 Exceptional mechanical properties (CVN >80J at -60°C)
 Superior product consistency with optimal alloy control
 Excellent wire feeding
 For PWHT, use Outershield 81K2-HSR

WELDING POSITIONS (ISO/ASME)



CURRENT TYPE / SHIELDING GAS (ISO 14175)

DC +
 M21 : Mixed gas Ar+ (>15-25%) CO₂
 Flow rate: 15-25 l/min

APPROVALS

Shielding gas	DNV	RINA	LR	RMRS	CWB
M21	IVY46MSH5	4YS	4Y40SH5	4Y50SH5	+

CHEMICAL COMPOSITION (W%), TYPICAL, ALL WELD METAL

Shielding gas	C	Mn	Si	P	S	Ni	HDM
M21	0.04	1.4	0.2	0.012	0.010	1.4	3 ml/100 g

MECHANICAL PROPERTIES, TYPICAL, ALL WELD METAL

	Shielding gas	Condition	Yield strength (N/mm ²)	Tensile strength (N/mm ²)	Elongation (%)	Impact ISO-V(J)		
						-40°C	-50°C	-60°C
Required: AWS A5.29 EN ISO 17632-A			min. 470 min. 500	550-690 560-720	min. 19 min. 18	min. 27		
Typical values	M21	AW	590	630	23	130	100	80

PACKAGING AND AVAILABLE SIZES

Diameter (mm)	1.2	1.6
4.5 kg plastic spool S200	X	
14 kg S300 (alu bag)	X	
15 kg spool B300	X	
25 kg wire reel B435		X

Outershield® 81K2-H: rev. C-ENZ7-01/02/16

Outershield® 81K2-H

EXAMPLES OF MATERIALS TO BE WELDED

Steel grades/Standard	Type
General structural steels	
EN 10025 part 2	S185, S235, S275, S355
Ship plates	
ASTM A131	Grade A, B, D, AH32 to EH40
Cast steels	
EN 10213-2	G P 240R
Pipe material	
EN 10208-1	L210, L240, L290, L360
EN 10208-2	L240NB, L290NB, L360NB, L360QB, L240MB, L290MB, L360MB, L415MB, L415NB
API 5LX	X42, X46, X52, X60, X65, X70
EN 10216-1/	P235T1, P235T2, P275T1
EN 10217-1	P275T2, P355N
Boiler & pressure vessel steels	
EN 10028-2	P235GH, P265GH, P295GH, P355GH
Fine grained steels	
EN 10025 part 3	S275N, S275NL, S355N, S355NL, S420N, S420NL, S460N, S460NL
EN 10025 part 4	S275M, S275ML, S355M, S355ML, S420M, S420ML, S460M, S460ML
EN 10025 part 6	S460Q, S460QL, S460QL1, S500S, S500QL, S500QL1

CALCULATION DATA

Diameter (mm)	Electrical stick-out (mm)	Wire Feed Speed (cm/min)	Current (A)	Arc Voltage (V)	Deposition rate (kg/h)	kg wire/kg weldmetal
1.2	20	445	130	20-22	1.6	1.20
		700	180	23-25	2.5	1.20
		950	220	25-27	3.4	1.20
		1270	265	27-29	4.5	1.20
		1590	305	30-32	5.9	1.20
1.6	20	320	170	21-23	1.9	1.20
		510	235	22-24	3.1	1.20
		635	275	24-25	3.9	1.20
		760	310	25-27	4.7	1.20
		890	350	27-29	5.6	1.20
		1015	385	28-30	6.4	1.20
		1080	400	30-31	6.8	1.20

FCAW

WELDING PARAMETERS, OPTIMUM FILL PASSES IN SHIELDING GAS Ar + (>15-25)% CO₂

Diameter (mm)	Welding positions				
	PA/1G	PB/2F	PC/2G	PF/3Gup	PE/4G
1.2	230-280A	230-280A	200-240A	200-240A	160-220A
	26-32V	26-32V	25-32V	25-28V	23-28V
1.6	250-350A	250-350A	230-280A	220-260A	170-240A
	24-32V	24-32V	24-32V	24-28V	22-28V

Outershield® 81K2-HSR

CLASSIFICATION

AWS A5.29	E81T1-K2M-JH4	A-Nr	10
EN ISO 17632-A	T 50 6 1.5Ni P M 2 H T	F-Nr	6
		9606 FM	2

GENERAL DESCRIPTION

All position gas shielded 1.5% Ni alloyed flux cored wire for offshore and similar applications
 Specific design for stress relieved applications, guaranteed impact properties after PWHT
 Superior weldability, low spatter, good bead appearance and outstanding operators appeal
 Exceptional mechanical properties [CVN >80J at -60°C]
 Superior product consistency with optimal alloy control
 Excellent wire feeding

WELDING POSITIONS (ISO/ASME)

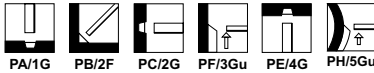

CURRENT TYPE / SHIELDING GAS (ISO 14175)

DC +
 M21 : Mixed gas Ar+ (>15-25%) CO₂
 Flow rate: 15-25 l/min

CHEMICAL COMPOSITION (W%), TYPICAL, ALL WELD METAL

Shielding gas	C	Mn	Si	P	S	Ni	HDM
M21	0.06	1.3	0.3	0.012	0.010	1.4	3 ml/100 g

MECHANICAL PROPERTIES, TYPICAL, ALL WELD METAL

	Shielding gas	Condition	Yield strength [N/mm ²]	Tensile strength [N/mm ²]	Elongation [%]	Impact ISO-V(J)		
						-40°C	-50°C	-60°C
Required: AWS A5.29 EN ISO 17632-A			min. 470 min. 500	550-690 560-720	min. 19 min. 18	min. 27		
Typical values	M21	AW SR	590 570	630 620	23 23	140	100	80 85

SR 1h/600°C, 3G up - V45°

PACKAGING AND AVAILABLE SIZES

Diameter (mm)	1.2
4.5 kg plastic spool S200	X
15 kg spool B300	X

Outershield® 81K2-HSR: rev. C-EN27-12/05/16

Outershield® 81K2-HSR

EXAMPLES OF MATERIALS TO BE WELDED

Steel grades/Standard	Type
General structural steels	
EN 10025 part 2	S185, S235, S275, S355
Ship plates	
ASTM A131	Grade A, B, D, AH32 to EH40
Cast steels	
EN 10213-2	G P 240R
Pipe material	
EN 10208-1	L210, L240, L290, L360
EN 10208-2	L240NB, L290NB, L360NB, L360QB, L240MB, L290MB, L360MB, L415MB, L415NB
API 5LX	X42, X46, X52, X60, X65, X70
EN 10216-1/	P235T1, P235T2, P275T1
EN 10217-1	P275T2, P355N
Boiler & pressure vessel steels	
EN 10028-2	P235GH, P265GH, P295GH, P355GH
Fine grained steels	
EN 10025 part 3	S275N, S275NL, S355N, S355NL, S420N, S420NL, S460N, S460NL
EN 10025 part 4	S275M, S275ML, S355M, S355ML, S420M, S420ML, S460M, S460ML
EN 10025 part 6	S460Q, S460QL, S460QL1, S500S, S500QL, S500QL1

CALCULATION DATA

Diameter (mm)	Electrical stick-out (mm)	Wire Feed Speed (cm/min)	Current (A)	Arc Voltage (V)	Deposition rate (kg/h)	kg wire/ kg weldmetal
1.2	20	445	130	20-22	1.6	1.20
		700	180	23-25	2.5	1.20
		950	220	25-27	3.4	1.20
		1270	265	27-29	4.5	1.20
		1590	305	30-32	5.9	1.20

WELDING PARAMETERS, OPTIMUM FILL PASSES IN SHIELDING GAS Ar + (>15-25)% CO₂

Diameter (mm)	Welding positions				
	PA/1G	PB/2F	PC/2G	PF/3Gup	PE/4G
1.2	230-280A	230-280A	200-240A	200-240A	160-220A
	26-32V	26-32V	25-32V	25-28V	23-28V

Outershield® 91Ni1-HSR

CLASSIFICATION

AWS A5.29	E91T1-GM-H4	A-Nr	10
ISO 18276-A	T 55 4 1NiMo P M 2 H5	F-Nr	6
		9606 FM	2

GENERAL DESCRIPTION

All position gas shielded 1% Ni and 0.4%Mo alloyed flux cored wire for offshore, pipeline and similar applications
 Specific design for stress relieved applications, guaranteed impact properties after PWHT
 Superior weldability, low spatter, good bead appearance and outstanding operators appeal
 Exceptional mechanical properties
 Superior product consistency with optimal alloy control
 Excellent wire feeding
 Specific design to withstand high heat input procedures
 Meets NACE MR-0175 requirements

WELDING POSITIONS (ISO/ASME)



CURRENT TYPE / SHIELDING GAS (ISO 14175)

DC +
 M21 : Mixed gas Ar+ (>15-25%) CO₂
 Flow rate: 15-25 l/min

CHEMICAL COMPOSITION (W%), TYPICAL, ALL WELD METAL

Shielding gas	C	Mn	Si	P	S	Ni	Mo	HDM
M21	0.05	1.4	0.2	0.013	0.010	0.95	0.4	3 ml/100 g

MECHANICAL PROPERTIES, TYPICAL, ALL WELD METAL

	Shielding gas	Condition	Yield strength [N/mm ²]	Tensile strength [N/mm ²]	Elongation [%]	Impact ISO-V[J] -40°C
Required: AWS A5.29 ISO 18276-A			min. 540 min. 550	620-760 640-820	min. 17 min. 18	min. 47
Typical values	M21	AW	640	700	19	60

PACKAGING AND AVAILABLE SIZES

Diameter (mm)	1.2
14 kg spool S300	X
15 kg spool B300	X

Outershield® 91Ni1-HSR.rev.C-ENT2-01/052/16

Outershield® 91Ni1-HSR

EXAMPLES OF MATERIALS TO BE WELDED

Steel grades/Standard	Type
General structural steels	
EN 10025 part 2	S185, S235, S275, S355
Ship plates	
ASTM A131	Grade A, B, C, D, AH32 to DH36
Cast steels	
EN 10213-2	G P 240R
Pipe material	
EN 10208-1	L210, L240, L290, L360
EN 10208-2	L240NB, L290NB, L360NB, L360QB, L240MB, L290MB, L360MB, L415MB, L415NB
API 5LX	X42, X46, X52, X60, X65, X70, X80
EN 10216-1/	P235T1, P235T2, P275T1
EN 10217-1	P275T2, P355N
Boiler & pressure vessel steels	
EN 10028-2	P235GH, P265GH, P295GH, P355GH, P420GH, P460GH
Fine grained steels	
EN 10025 part 3	S275N, S275NL, S355N, S355NL, S420N, S420NL, S460N, S460NL
EN 10025 part 4	S275M, S275ML, S355M, S355ML, S420M, S420ML, S460M, S460ML
EN 10025 part 6	S460Q, S460QL1, S500Q, S500QL1, S550Q, S550QL1

CALCULATION DATA

Diameter (mm)	Electrical stick-out (mm)	Wire Feed Speed (cm/min)	Current (A)	Arc Voltage (V)	Deposition rate (kg/h)	kg wire/ kg weldmetal
1.2	20	445	130	20-22	1.6	1.20
		700	180	23-25	2.5	1.20
		950	220	25-27	3.4	1.20
		1270	265	27-29	4.5	1.20
		1590	305	30-32	5.9	1.20

WELDING PARAMETERS, OPTIMUM FILL PASSES IN SHIELDING GAS Ar + (>15-25)% CO₂

Diameter (mm)	Welding positions				
	PA/1G	PB/2F	PC/2G	PF/3Gup	PE/4G
1.2	230-280A	230-280A	200-240A	200-240A	160-220A
	26-32V	26-32V	25-32V	25-28V	23-28V

Outershield® 91K2-HSR

CLASSIFICATION

AWS A5.29	E91T1-GM-H4	A-Nr	10
ISO 18276-A	T 55 4 1,5NiMo P M 2 H5	F-Nr	6
		9606 FM	2

GENERAL DESCRIPTION

All position gas shielded 1.5% Ni and 0.4%Mo alloyed flux cored wire for offshore, pipeline and similar applications
 Specific design for stress relieved applications, guaranteed impact properties after PWHT
 Superior weldability, low spatter, good bead appearance and outstanding operators appeal
 Exceptional mechanical properties
 Superior product consistency with optimal alloy control
 Excellent wire feeding
 Specific design to withstand high heat input procedures

WELDING POSITIONS (ISO/ASME)



PA/1G



PB/2F



PC/2G



PF/3Gu



PH/5Gu



PE/4G

CURRENT TYPE / SHIELDING GAS (ISO 14175)

DC +
 M21 : Mixed gas Ar+ (>15-25%) CO₂
 Flow rate: 15-25 l/min

CHEMICAL COMPOSITION (W%), TYPICAL, ALL WELD METAL

Shielding gas	C	Mn	Si	P	S	Ni	Mo	HDM
M21	0.05	1.4	0.2	0.013	0.010	1.4	0.4	3 ml/100 g

MECHANICAL PROPERTIES, TYPICAL, ALL WELD METAL

	Shielding gas	Condition	Yield strength (N/mm ²)	Tensile strength (N/mm ²)	Elongation (%)	Impact ISO-V(J)
						-40°C
Required: AWS A5.29			min. 540	620-760	min. 17	
ISO 18276-A			min. 550	640-820	min. 18	min. 47
Typical values	M21	AW	640	700	19	60

PACKAGING AND AVAILABLE SIZES

Diameter (mm)	1.2
4.5 kg plastic spool S200	X
14 kg spool S300	X
15 kg spool B300	X

Outershield® 91K2-HSR: rev. C-EN06-01/02/16

All information in this data sheet is accurate to the best of our knowledge at the time of printing. Please refer to www.lincolnelectric.eu for any updated information.
 Fumes: Safety Data Sheets (SDS) are available on our website.

Outershield® 91K2-HSR

EXAMPLES OF MATERIALS TO BE WELDED

Steel grades/Standard	Type
General structural steels	
EN 10025 part 2	S185, S235, S275, S355
Ship plates	
ASTM A131	Grade A, B, C, D, AH32 to DH36
Cast steels	
EN 10213-2	G P 240R
Pipe material	
EN 10208-1	L210, L240, L290, L360
EN 10208-2	L240NB, L290NB, L360NB, L360QB, L240MB, L290MB, L360MB, L415MB, L415NB
API 5LX	X42, X46, X52, X60, X65, X70, X80
EN 10216-1/	P235T1, P235T2, P275T1
EN 10217-1	P275T2, P355N
Boiler & pressure vessel steels	
EN 10028-2	P235GH, P265GH, P295GH, P355GH, P420GH, P460GH
Fine grained steels	
EN 10025 part 3	S275N, S275NL, S355N, S355NL, S420N, S420NL, S460N, S460NL
EN 10025 part 4	S275M, S275ML, S355M, S355ML, S420M, S420ML, S460M, S460ML
EN 10025 part 6	S460Q, S460QL1, S500Q, S500QL1, S550Q, S550QL1

CALCULATION DATA

Diameter (mm)	Electrical stick-out (mm)	Wire Feed Speed (cm/min)	Current (A)	Arc Voltage (V)	Deposition rate (kg/h)	kg wire/ kg weldmetal
1.2	20	445	130	20-22	1.6	1.20
		700	180	23-25	2.5	1.20
		950	220	25-27	3.4	1.20
		1270	265	27-29	4.5	1.20
		1590	305	30-32	5.9	1.20

WELDING PARAMETERS, OPTIMUM FILL PASSES IN SHIELDING GAS Ar + (>15-25)% CO₂

Diameter (mm)	Welding positions				
	PA/1G	PB/2F	PC/2G	PF/3Gup	PE/4G
1.2	230-280A	230-280A	200-240A	200-240A	160-220A
	26-32V	26-32V	25-32V	25-28V	23-28V

Outershield® 101Ni1-HSR

CLASSIFICATION

AWS A5.29	E101T1-G-H4	A-Nr	11
		F-Nr	6
		9606 FM	2

GENERAL DESCRIPTION

Rutile micro alloyed flux-cored wire for welding in all positions, special of high carbon containing low alloy high strength steels such as SAE 4130
 Specific design for stress relieved applications
 Outstanding operator appeal
 Excellent mechanical properties (CVN >50J at -40°C)
 Superior product consistency with optimal alloy control
 Good wire feeding
 Meets NACE MR-0175 requirements

WELDING POSITIONS (ISO/ASME)



PA/1G



PB/2F



PC/2G



PF/3Gu



PE/4G



PH/5Gu

CURRENT TYPE / SHIELDING GAS (ISO 14175)

DC +
 M21 : Mixed gas Ar+ (>15-25%) CO₂
 Flow rate: 15-25 l/min

CHEMICAL COMPOSITION (W%), TYPICAL, ALL WELD METAL

Shielding gas	C	Mn	Si	P	S	Ni	Mo	HDM
M21	0.06	2.0	0.3	0.013	0.010	0.95	0.4	3 ml/100 g

MECHANICAL PROPERTIES, TYPICAL, ALL WELD METAL

	Shielding gas	Condition	Yield strength (N/mm ²)	Tensile strength (N/mm ²)	Elongation (%)	Impact ISO-V(J)	
						-40°C	-50°C
Required: AWS A5.29			min. 610	830	min. 16		min. 27
Typical values	M21	AW	750	810	17	60	40
		SR	690	780	18		50

SR: 4h/645°C

PACKAGING AND AVAILABLE SIZES

Diameter (mm)	1.2
14 kg spool S300	X

Outershield® 101Ni1-HSR: rev. C-EN06-12/05/16

All information in this data sheet is accurate to the best of our knowledge at the time of printing. Please refer to www.lincolnelectric.eu for any updated information.
 Fumes: Safety Data Sheets (SDS) are available on our website.

Outershield® 101Ni1-HSR

EXAMPLES OF MATERIALS TO BE WELDED

Steel grades/Standard	Type
Fine grained steels	
EN 10025 part 6	S500Q to S620QL1
AISI/SAE	4130-4140
ASTM A1031	Grade 4130
ASTM A519	Grade 4130

CALCULATION DATA

Diameter (mm)	Electrical stick-out (mm)	Wire Feed Speed (cm/min)	Current (A)	Arc Voltage (V)	Deposition rate (kg/h)	kg wire/kg weldmetal
1.2	20	445	130	20-22	1.6	1.20
		700	180	23-25	2.5	1.20
		950	220	25-27	3.4	1.20
		1270	265	27-29	4.5	1.20
		1590	305	30-32	5.9	1.20

WELDING PARAMETERS, OPTIMUM FILL PASSES IN SHIELDING GAS Ar + (>15-25)% CO₂

Diameter (mm)	Welding positions				
	PA/1G	PB/2F	PC/2G	PF/3Gup	PE/4G
1.2	230-280A	230-280A	200-240A	200-240A	160-220A
	26-32V	26-32V	25-32V	25-28V	23-30V

Outershield® 690-H

CLASSIFICATION

AWS A5.29	E11T1-K3M-JH4	A-Nr	10
ISO 18276-A	T 69 4 Z P M 2 H5	F-Nr	6
		9606 FM	2

GENERAL DESCRIPTION

All position gas shielded rutile flux cored wire, for high strength steel grades like grade S690
 Outstanding operator appeal
 Excellent mechanical properties (CVN >70J at -40°C)
 Superior product consistency with optimal alloy control
 Good wire feeding

WELDING POSITIONS (ISO/ASME)



PA/1G



PB/2F



PC/2G



PF/3Gu



PE/4G



PH/5Gu

CURRENT TYPE / SHIELDING GAS (ISO 14175)

DC +
 M21 : Mixed gas Ar+ (>15-25%) CO₂
 Flow rate: 15-25 l/min

APPROVALS

Shielding gas	ABS	DNV	LR	GL	RINA
M21	4YQ690H5	IVY69SH5	4Y69SH5	4Y69H55	4Y69SH5

CHEMICAL COMPOSITION (W%), TYPICAL, ALL WELD METAL

Shielding gas	C	Mn	Si	P	S	Ni	Mo	HDM
M21	0.06	1.5	0.2	0.015	0.010	2.0	0.3	3 ml/100 g

MECHANICAL PROPERTIES, TYPICAL, ALL WELD METAL

	Shielding gas	Condition	Yield strength (N/mm ²)	Tensile strength (N/mm ²)	Elongation (%)	Impact ISO-V(J)		
						-29°C	-40°C	-46°C
Required: AWS A5.29 ISO 18276-A			min. 680 min. 690	760-900 770-940	min. 15 min. 17	min. 27	min. 47	
Typical values	M21	AW	780	810	18	85	80	65

PACKAGING AND AVAILABLE SIZES

Diameter (mm)	1.2	1.6
4.5 kg plastic spool S200	X	
14 kg S300 (alu bag)		X
15 kg spool B300	X	X

Outershield® 690-H: rev. C-EN28-12/05/16

All information in this data sheet is accurate to the best of our knowledge at the time of printing. Please refer to www.lincolnelectric.eu for any updated information.
 Fumes: Safety Data Sheets (SDS) are available on our website.

Outershield® 690-H

EXAMPLES OF MATERIALS TO BE WELDED

Steel grades/Standard	Type
Fine grained steels	
EN 10025 part 6	S500Q to S690QL1
API 5L	X100
MIL-S-162164	HY100
ASTM A514	Grade F
ASTM A517	Grade A, B, F, H, D
ASTM A709	Grade 690 type F, grade 100W type F

CALCULATION DATA

Diameter (mm)	Electrical stick-out (mm)	Wire Feed Speed (cm/min)	Current (A)	Arc Voltage (V)	Deposition rate (kg/h)	kg wire/kg weldmetal
1.2	20	445	130	20-22	1.6	1.20
		700	180	23-25	2.5	1.20
		950	220	25-27	3.4	1.20
		1270	265	27-29	4.5	1.20
		1590	305	30-32	5.9	1.20
1.6	20	320	170	21-23	1.9	1.20
		510	235	22-24	3.1	1.20
		635	275	24-25	3.9	1.20
		760	310	25-27	4.7	1.20
		890	350	27-29	5.6	1.20
		1015	385	28-30	6.4	1.20
		1080	400	30-31	6.8	1.20

FCAW

WELDING PARAMETERS, OPTIMUM FILL PASSES IN SHIELDING GAS Ar + (>15-25)% CO₂

Diameter (mm)	Welding positions				
	PA/1G	PB/2F	PC/2G	PF/3Gup	PE/4G
1.2	230-280A	230-280A	200-240A	200-240A	160-220A
	26-32V	26-32V	25-32V	25-28V	23-30V
1.6	250-350A	250-350A	230-280A	220-260A	170-240A
	24-29V	24-29V	24-28V	24-26V	22-26V

Outershield® 690-HSR

CLASSIFICATION

AWS A5.29	E11T1-K3M-JH4	A-Nr	10
ISO 18276-A	T 69 4 Z P M 2 H5 T	F-Nr	6
		9606 FM	2

GENERAL DESCRIPTION

All position gas shielded rutile flux cored wire, for high strength steel grades like grade S690
 Specific design for stress relieved applications, guaranteed impact properties after PWHT
 Outstanding operator appeal
 Excellent mechanical properties (CVN >50J at -40°C)
 Superior product consistency with optimal alloy control
 Good wire feeding

WELDING POSITIONS (ISO/ASME)



PA/1G



PB/2F



PC/2G



PF/3Gu



PE/4G



PH/5Gu

CURRENT TYPE / SHIELDING GAS (ISO 14175)

DC +
 M21 : Mixed gas Ar+ (>15-25%) CO₂
 Flow rate: 15-25 l/min

CHEMICAL COMPOSITION (W%), TYPICAL, ALL WELD METAL

Shielding gas	C	Mn	Si	P	S	Ni	Mo	HDM
M21	0.06	1.5	0.2	0.015	0.010	2.0	0.5	3 ml/100 g

MECHANICAL PROPERTIES, TYPICAL, ALL WELD METAL

Shielding gas	Condition	Yield strength (N/mm ²)	Tensile strength (N/mm ²)	Elongation (%)	Impact ISO-V(J)	
					-29°C/-30°C	-40°C
Required: AWS A5.29 ISO 18276-A		min. 680	760-900	min. 15	min. 27	
		min. 690	770-940	min. 17	min. 47	
Typical values	M21	AW	740	19	75	70
		SR	720	20	75	60

SR: 1h/580°C, 3G up - V60°

PACKAGING AND AVAILABLE SIZES

Diameter (mm)	1.2	1.6
15 kg spool B300	X	X

Outershield® 690-HSR: rev. C-EN27-12/05/16

Outershield® 690-HSR

EXAMPLES OF MATERIALS TO BE WELDED

Steel grades/Standard	Type
Fine grained steels	
EN 10025 part 6	S500Q to S690QL1
API 5L	X100
MIL-S-162164	HY100
ASTM A514	Grade F
ASTM A517	Grade A, B, F, H, D
ASTM A709	Grade 690 type F, grade 100W type F

CALCULATION DATA

Diameter (mm)	Electrical stick-out (mm)	Wire Feed Speed (cm/min)	Current (A)	Arc Voltage (V)	Deposition rate (kg/h)	kg wire/kg weldmetal
1.2	20	445	130	20-22	1.6	1.20
		700	180	23-25	2.5	1.20
		950	220	25-27	3.4	1.20
		1270	265	27-29	4.5	1.20
		1590	305	30-32	5.9	1.20
1.6	20	320	170	21-23	1.9	1.20
		510	235	22-24	3.1	1.20
		635	275	24-25	3.9	1.20
		760	310	25-27	4.7	1.20
		890	350	27-29	5.6	1.20
		1015	385	28-30	6.4	1.20
		1080	400	30-31	6.8	1.20

FCAW

WELDING PARAMETERS, OPTIMUM FILL PASSES IN SHIELDING GAS Ar + (>15-25)% CO₂

Diameter (mm)	Welding positions				
	PA/1G	PB/2F	PC/2G	PF/3Gup	PE/4G
1.2	230-280A	230-280A	200-240A	200-240A	160-220A
	26-32V	26-32V	25-32V	25-28V	23-30V
1.6	250-350A	250-350A	230-280A	220-260A	170-240A
	24-29V	24-29V	24-28V	24-26V	22-26V

Outershield® 500CT-H

CLASSIFICATION

AWS A5.29	E81T1-GM-H4	A-Nr	10
ISO 18276-A	T 50 5 Z P M 2 H5	F-Nr	6
		9606 FM	2

GENERAL DESCRIPTION

All position gas shielded 0.8% Ni and 0.4% Cu flux cored wire, for welding weather resistant steel (CorTen)

For welding in all positions

Superior weldability, low spatter, good bead appearance

Outstanding operator appeal

Exceptional mechanical properties [CVN >47] at -50°C

Superior product consistency with optimal alloy control

Excellent wire feeding

For welding applications with higher service temperatures (i.e chimneys), Outershield 555CT-H is recommended.

WELDING POSITIONS (ISO/ASME)



PA/1G



PB/2F



PC/2G



PF/3Gu



PE/4G

CURRENT TYPE / SHIELDING GAS (ISO 14175)

DC +
M21 : Mixed gas Ar+ (>15-25%) CO₂
Flow rate: 15-25 l/min

CHEMICAL COMPOSITION (W%), TYPICAL, ALL WELD METAL

Shielding gas	C	Mn	Si	P	S	Ni	Cu	HDM
M21	0.04	1.3	0.2	0.014	0.010	0.84	0.39	4 ml/100 g

MECHANICAL PROPERTIES, TYPICAL, ALL WELD METAL

	Shielding gas	Condition	Yield strength [N/mm ²]	Tensile strength [N/mm ²]	Elongation [%]	Impact ISO-V(J)
						-50°C
Required: AWS A5.29			min. 470	550-690	min. 19	not required
EN ISO 17632-A			min. 500	560-720	min. 18	min. 47
Typical values	M21	AW	580	610	23	80

PACKAGING AND AVAILABLE SIZES

Diameter (mm)	1.2
15 kg spool B300	X

Outershield® 500CT-H: rev. C-EN26-01/02/16

All information in this data sheet is accurate to the best of our knowledge at the time of printing. Please refer to www.lincolnelectric.eu for any updated information.
Fumes: Safety Data Sheets (SDS) are available on our website.

Outershield® 500CT-H

EXAMPLES OF MATERIALS TO BE WELDED

Steel grades/Standard	Type
Weather resisting steels	
EN 10025 part 5	S235 J0W, S235 J2W, S355 J0WP, S355 J2WP, S355 J0W, S355 J2W, S355 K2W
ASTM A242	Type 1
ASTM A588	Grade A, B, C
ASTM A595	All weather resistant steels according A595
ASTM A709	Grade HPS 50W & HPS 70W
ISO 5952	HSA 235W, 245W, 355W1, 355W2, 365W

Weather resistant steels like Cor-Ten®, Patinax®-F, Patinax®-37 and similar Ni- and Cu-alloyed steels

CALCULATION DATA

Diameter (mm)	Electrical stick-out (mm)	Wire Feed Speed (cm/min)	Current (A)	Arc Voltage (V)	Deposition rate (kg/h)	kg wire/ kg weldmetal
1.2	20	445	130	20-22	1.6	1.20
		700	180	23-25	2.5	1.20
		950	220	25-27	3.4	1.20
		1270	265	27-29	4.5	1.20
		1590	305	30-32	5.9	1.20

WELDING PARAMETERS, OPTIMUM FILL PASSES IN SHIELDING GAS Ar + [15-25]% CO₂

Diameter (mm)	Welding positions				
	PA/1G	PB/2F	PC/2G	PF/3Gup	PE/4G
1.2	230-280A 26-32V	230-280A 26-32V	200-240A 25-32V	200-240A 25-28V	160-220A 23-28V

Outershield® 555CT-H

CLASSIFICATION

AWS A5.29	E81T1-W2M-JH4	A-Nr	2
ISO 18276-A	T555T1-1MA-NCC1-UH5	F-Nr	6
		9606 FM	2

GENERAL DESCRIPTION

All position gas shielded 0.6% Ni, 0.5Cr and 0.5% Cu alloyed flux cored wire, for welding weather resistant steel (CorTen)

For welding in all positions

Superior weldability, low spatter, good bead appearance

Outstanding operator appeal

Exceptional mechanical properties (CVN >47J at -50°C)

Superior product consistency with optimal alloy control

Excellent wire feeding

WELDING POSITIONS (ISO/ASME)



PA/1G



PB/2F



PC/2G



PF/3Gu



PE/4G

CURRENT TYPE / SHIELDING GAS (ISO 14175)

DC +
M21 : Mixed gas Ar+ (>15-25%) CO₂
Flow rate: 15-25 l/min

CHEMICAL COMPOSITION (W%), TYPICAL, ALL WELD METAL

Shielding gas	C	Mn	Si	P	S	Ni	Cr	Cu	HDM
M21	0.03	1.1	0.4	0.015	0.010	0.60	0.55	0.55	4 ml/100 g

MECHANICAL PROPERTIES, TYPICAL, ALL WELD METAL

	Shielding gas	Condition	Yield strength (N/mm ²)	Tensile strength (N/mm ²)	Elongation (%)	Impact ISO-V(J)	
						-40°C	-50°C
Required: AWS A5.29			min. 470	550-690	min. 19	min. 27	
EN ISO 17632-B			min. 460	550-740	min. 17	min. 47	
Typical values	M21	AW	600	660	20	140	100

PACKAGING AND AVAILABLE SIZES

Diameter (mm)	1.2
15 kg spool B300	X

Outershield® 555CT-H: rev. C-EN03-01/02/16

Outershield® 555CT-H

EXAMPLES OF MATERIALS TO BE WELDED

Steel grades/Standard	Type
Weather Resisting Steel	
EN 10025 part 5	S235 J0W, S235 J2W, S355 J0WP, S355 J2WP, S355 J0W, S355 J2W, S355 K2W
ASTM A242	Type 1
ASTM A588	Grade A, B, C
ASTM A595	All weather resistant steels according A595
ASTM A709	Grade HPS 50W & HPS 70W
ISO 5952	HSA 235W, 245W, 355W1, 355W2, 365W
Weather resistant steels like Cor-Ten®, Patinax®-F, Patinax®-37 and similar Ni- and Cu-alloyed steels	

CALCULATION DATA

Diameter (mm)	Electrical stick-out (mm)	Wire Feed Speed (cm/min)	Current (A)	Arc Voltage (V)	Deposition rate (kg/h)	kg wire/kg weldmetal
1.2	20	445	130	20-22	1.6	1.20
		700	180	23-25	2.5	1.20
		950	220	25-27	3.4	1.20
		1270	265	27-29	4.5	1.20
		1590	305	30-32	5.9	1.20

WELDING PARAMETERS, OPTIMUM FILL PASSES IN SHIELDING GAS Ar + (>15-25)% CO₂

Diameter (mm)	Welding positions				
	PA/1G	PB/2F	PC/2G	PF/3Gup	PE/4G
1.2	230-280A	230-280A	200-240A	200-240A	160-220A
	26-32V	26-32V	25-32V	25-28V	23-28V

Outershield® MC555CT-H

CLASSIFICATION

AWS A5.28	E80C-W2 H4	A-Nr	2
EN ISO 17632-B	T554T15-0MA-NCC1-UH5	F-Nr	6
		9606 FM	2

GENERAL DESCRIPTION

Gas shielded 0,5%Ni-0,5%Cu-0,5%Cr alloyed metal cored wire for welding weather resistant (CoTen) steel grade
 Excellent arc characteristics give outstanding operator appeal
 Virtually no spatter, high travel speed and excellent wire feeding
 Excellent mechanical properties (CVN >47) at -40°C
 Superior product consistency with optimal alloy control

APPROVALS

Shielding gas	TUV
M21	+

WELDING POSITIONS (ISO/ASME)



CURRENT TYPE / SHIELDING GAS (ISO 14175)

DC +
 M21 : Mixed gas Ar+ (>15-25%) CO₂
 Flow rate: 15-25 l/min

CHEMICAL COMPOSITION (W%), TYPICAL, ALL WELD METAL

Shielding gas	C	Mn	Si	P	S	Ni	Cr	Cu	HDM
M21	0.03	1.3	0.4	0.015	0.020	0.55	0.55	0.55	3 ml/100 g

MECHANICAL PROPERTIES, TYPICAL, ALL WELD METAL

	Shielding gas	Condition	Yield strength (N/mm ²)	Tensile strength (N/mm ²)	Elongation (%)	Impact ISO-V(J)		
						-30°C	-40°C	-50°C
Required: AWS A5.28 EN ISO 17632-B			min. 470 min. 460	min. 550 550-740	min. 19 min. 17	min. 27	min. 47	
Typical values	M21	AW	650	680	22	80	70	60

PACKAGING AND AVAILABLE SIZES

Diameter (mm)	1.2
15 kg spool B300	X

Outershield® MC555CT-H; rev. C-EN02-01/02/16

Outershield® MC555CT-H

EXAMPLES OF MATERIALS TO BE WELDED

Steel grades/Standard	Type
Weather resisting steels	
EN 10155 / 100025-5	S235 J0W, S235 J2W, S355 J0W, S 355 J0WP, S 355 J2 W, S 355 J2WP, S 355 J2G1W, S 355 J2G2W, S 355 K2G1W, S 355 K2G2W
ASTM A242	Type 1
ASTM A588	Grade A, B, C, K
ASTM A709	Grade HPS 50 & WHPS 70W
ISO 5952	HSA 235W, 245W, 355W1, 355W2, 365W
Without classification:	Specified yield up to 550 MPa Specified CVN down to -50°C

CALCULATION DATA

Diameter (mm)	Arc mode	Electrical stick-out (mm)	Wire Feed Speed (cm/min)	Current (A)	Arc Voltage (V)	Deposition rate (kg/h)	kg wire/kg weldmetal
1.2	Short arc	15	230	100	15	1.1	1.10
			320	120	16	1.4	1.10
			400	150	17	1.9	1.10
	Spray Arc	20	635	180	28-30	2.7	1.10
			940	275	31-34	4.8	1.10
			1420	340	35-38	6.8	1.10

WELDING PARAMETERS, OPTIMUM FILL PASSES IN SHIELDING GAS Ar + (>15-25)% CO₂

Diameter (mm)	Welding positions				
	PA/1G	PB/2F	PC/2G	PF/3Gup	PE/4G
1.2	230-380A	230-380A	230-300A	130-170A	140-175A
	26-36V	26-36V	26-30V	15-17V	16-17V

Outershield® 12-H

CLASSIFICATION

AWS A5.29	E81T1-A1M-H4	A-Nr	2
ISO 17634-A	T MoL P M 2 H5	F-Nr	6
		9606 FM	1/3

GENERAL DESCRIPTION

All position mix gas shielded 0.5% Mo-alloyed rutile cored wire
 Superior weldability, low spatter, good bead appearance
 Outstanding operator appeal
 Superior product consistency with optimal alloy control
 Excellent wire feeding

WELDING POSITIONS (ISO/ASME)



PA/1G



PB/2F



PC/2G



PF/3Gu



PE/4G

CURRENT TYPE / SHIELDING GAS (ISO 14175)

DC +
 M21 : Mixed gas Ar+ (>15-25%) CO₂
 Flow rate: 15-25 l/min

APPROVALS

Shielding gas	TÜV
M21	+

CHEMICAL COMPOSITION (W%), TYPICAL, ALL WELD METAL

Shielding gas	C	Mn	Si	P	S	Mo	HDM
M21	0.065	0.8	0.2	0.014	0.010	0.46	3 ml/100 g

MECHANICAL PROPERTIES, TYPICAL, ALL WELD METAL

	Shielding gas	Condition	Yield strength (N/mm ²)	Tensile strength (N/mm ²)	Elongation (%)	Impact ISO-V(J)	
						+20°C	-20°C
Required: AWS A5.29		SR ⁽¹⁾	min. 470	550-690	min. 19	not required	
ISO 17634-A		SR ⁽²⁾	min. 355	min. 510	min. 22	min. 47	
Typical values	M21	SR ⁽³⁾	540	600	27	160	79
Stress relieving: SR ⁽¹⁾ = 620 ± 15°C/1h, SR ⁽²⁾ = 570-620°C/1h, SR ⁽³⁾ = 1h/620°C							

PACKAGING AND AVAILABLE SIZES

Diameter (mm)	1.2
15 kg spool B300	X

Outershield® 12-Ht. rev. C-EN26-01/02/16

Outershield® 12-H

EXAMPLES OF MATERIALS TO BE WELDED

Steel grades/Standard	Type
Creep resistant steels	
EN 10028-2	P295GH, P355GH, 16Mo3 & similar alloys
EN 10222-2	17Mo3, 14Mo6 & similar alloys
ASTM A335	Grade P1
ASTM A209	Grade T1
ASTM A250	Grade T1
ASTM A336	Grade F1
ASTM A204	Grade A, B, C
ASTM A217	Grade WC1
ASTM A352	Grade LC1
Fine grained steels	
EN 10025 part 3	S275, S355, S420
EN 10025 part 4	S275, S355, S420

CALCULATION DATA

Diameter (mm)	Electrical stick-out (mm)	Wire Feed Speed (cm/min)	Current (A)	Arc Voltage (V)	Deposition rate (kg/h)	kg wire/kg weldmetal
1.2	20	445	130	20-22	1.6	1.20
		700	180	23-25	2.5	1.20
		950	220	25-27	3.4	1.20
		1270	265	27-29	4.5	1.20
		1590	305	30-32	5.9	1.20

WELDING PARAMETERS, OPTIMUM FILL PASSES IN SHIELDING GAS Ar + {15-25}% CO₂

Diameter (mm)	Welding positions				
	PA/1G	PB/2F	PC/2G	PF/3Gup	PE/4G
1.2	230-280A	230-280A	200-240A	200-240A	160-220A
	26-32V	26-32V	25-32V	25-28V	23-28V

REMARKS/APPLICATION ADVICE

Recommended tempering heat treatment range: 570-630°C
Time depends on material thickness

FCAW

Outershield® 19-H

CLASSIFICATION

AWS A5.29	E 81T1-B2M-H4	A-Nr	3
ISO 17634-A	T CrMo1 P M 2 H5	F-Nr	6
		9606 FM	3

GENERAL DESCRIPTION

All position mix gas shielded 1.25% Cr 0.5% Mo-alloyed rutile cored wire
 Superior weldability, low spatter, good bead appearance
 Outstanding operator appeal
 Superior product consistency with optimal alloy control
 Excellent wire feeding

WELDING POSITIONS (ISO/ASME)



PA/1G



PB/2F



PC/2G



PF/3Gu



PE/4G

CURRENT TYPE / SHIELDING GAS (ISO 14175)

DC +
 M21 : Mixed gas Ar+ (>15-25%) CO₂
 Flow rate: 15-25 l/min

APPROVALS

Shielding gas	TÜV
M21	+

CHEMICAL COMPOSITION (W%), TYPICAL, ALL WELD METAL

Shielding gas	C	Mn	Si	P	S	Cr	Mo	HDM
M21	0.07	0.74	0.24	0.013	0.010	1.24	0.52	3 ml/100 g

MECHANICAL PROPERTIES, TYPICAL, ALL WELD METAL

	Shielding gas	Condition	Yield strength [N/mm ²]	Tensile strength [N/mm ²]	Elongation [%]	Impact ISO-V(J)	
						+20°C	-20°C
Required: AWS A5.29		SR ⁽¹⁾	min. 470	550-690	min. 19	not required	
ISO 17634-A		SR ⁽²⁾	min. 355	min. 510	min. 20	min. 47	
Typical values	M21	SR ⁽³⁾	545	635	21	150	80
Stress relieving: SR ¹ = 690 ± 15°C/1h, SR ² = 660-700°C/1h, SR ³ = 1h/690°C							

PACKAGING AND AVAILABLE SIZES

Diameter (mm)	1.2
15 kg spool B300	X

Outershield® 19-H: rev. C-EN25-01/02/16

Outershield® 19-H

EXAMPLES OF MATERIALS TO BE WELDED

Steel grades/Standard	Type
Creep resistant steels	
EN 10028-2	13CrMo4-5 & similar alloys
EN 10083-1	25CrMo4 & similar alloys
EN 10222-2	14CrMo4-5 & similar alloys
ASTM A387	Grade 11 & 12
ASTM A182	Grade F1 & F12
ASTM A217	Grade WC6 & WC11
ASTM A234	Grade WP11 & WP12
ASTM A199	Grade T11
ASTM A200	Grade T11
ASTM A213	Grade T11 & T12
ASTM A335	Grade P11 & P12
Tool steel	
DIN 17210	16MnCr5 & similar alloys

CALCULATION DATA

Diameter (mm)	Electrical stick-out (mm)	Wire Feed Speed (cm/min)	Current (A)	Arc Voltage (V)	Deposition rate (kg/h)	kg wire/kg weldmetal
1.2	20	445	130	20-22	1.6	1.20
		700	180	23-25	2.5	1.20
		950	220	25-27	3.4	1.20
		1270	265	27-29	4.5	1.20
		1590	305	30-32	5.9	1.20

WELDING PARAMETERS, OPTIMUM FILL PASSES IN SHIELDING GAS Ar + [≥15-25% CO₂]

Diameter (mm)	Welding positions				
	PA/1G	PB/2F	PC/2G	PF/3Gup	PE/4G
1.2	230-280A	230-280A	200-240A	200-240A	160-220A
	26-32V	26-32V	25-32V	25-28V	23-28V

REMARKS/APPLICATION ADVICE

Recommended preheat temperature: 200 - 250°C
 Recommended tempering heat treatment range: 660-700°C
 Time depends on material thickness

FCAW

Outershield® 20-H

CLASSIFICATION

AWS A5.29	E 91T1-B3M-H4	A-Nr	4
ISO 17634-A	T CrMo2 P M 2 H5	F-Nr	6
		9606 FM	3

GENERAL DESCRIPTION

All position mix gas shielded 2.25% Cr 1% Mo-alloyed rutile cored wire
 Superior weldability, low spatter, good bead appearance
 Outstanding operator appeal
 Superior product consistency with optimal alloy control
 Excellent wire feeding

WELDING POSITIONS (ISO/ASME)



PA/1G



PB/2F



PC/2G



PF/3Gu



PE/4G

CURRENT TYPE / SHIELDING GAS (ISO 14175)

DC +
 M21 : Mixed gas Ar+ (>15-25%) CO₂
 Flow rate: 15-25 l/min

APPROVALS

Shielding gas	TÜV
M21	+

CHEMICAL COMPOSITION (W%), TYPICAL, ALL WELD METAL

Shielding gas	C	Mn	Si	P	S	Cr	Mo	HDM
M21	0.07	0.75	0.21	0.013	0.008	2.23	1.09	3 ml/100 g

MECHANICAL PROPERTIES, TYPICAL, ALL WELD METAL

	Shielding gas	Condition	Yield strength (N/mm ²)	Tensile strength (N/mm ²)	Elongation (%)	Impact ISO-V(J)	
						+20°C	-20°C
Required: AWS A5.29		SR ⁽¹⁾	min. 540	620-760	min. 17	not required	
ISO 17634-A		SR ⁽²⁾	min. 400	min. 500	min. 18	min. 47	
Typical values	M21	SR ⁽³⁾	570	680	19	150	60
Stress relieving: SR ¹ = 690 ± 15°C/1h, SR ² = 690-750°C/1h, SR ³ = 1h/690°C							

PACKAGING AND AVAILABLE SIZES

Diameter (mm)	1.2
15 kg spool B300	X

Outershield® 20-Ht. rev. C-EN26-01/02/16

Outershield® 20-H

EXAMPLES OF MATERIALS TO BE WELDED

Steel grades/Standard	Type
Creep resistant steels	
EN 10028-2	10CrMo9-10 & similar alloys
EN 10222-2	12CrMo9-10 & similar alloys
ASTM A387	Grade 21 & 22
ASTM A182	Grade F22
ASTM A217	Grade WC9
ASTM A234	Grade WP22
ASTM A199/A200	Grade T21 & T22
ASTM A213	Grade T22
ASTM A335	Grade P22

CALCULATION DATA

Diameter (mm)	Electrical stick-out (mm)	Wire Feed Speed (cm/min)	Current (A)	Arc Voltage (V)	Deposition rate (kg/h)	kg wire/kg weldmetal
1.2	20	445	130	20-22	1.6	1.20
		700	180	23-25	2.5	1.20
		950	220	25-27	3.4	1.20
		1270	265	27-29	4.5	1.20
		1590	305	30-32	5.9	1.20

WELDING PARAMETERS, OPTIMUM FILL PASSES IN SHIELDING GAS Ar + (>15-25)% CO₂

Diameter (mm)	Welding positions				
	PA/1G	PB/2F	PC/2G	PF/3Gup	PE/4G
1.2	230-280A	230-280A	200-240A	200-240A	160-220A
	26-32V	26-32V	25-32V	25-28V	23-28V

REMARKS/APPLICATION ADVICE

Recommended preheat temperature: 200 - 250°C
 Recommended tempering heat treatment range: 690-750°C
 Time depends on material thickness

FCAW

Innershield® NR® 152

CLASSIFICATION

AWS A5.20	E71T-14	A-Nr	1
AWS A5.36	E71T-14S	F-Nr	6
EN ISO 17632-A	T 42 Z Z N 5	9606 FM	1

GENERAL DESCRIPTION

Designed for high speed welding of specially coated steels
 Soft, consistent arc
 Porosity resistant
 Excellent overlapping capabilities
 Ideal for robotic applications

WELDING POSITIONS (ISO/ASME)



PA/1G



PB/2F



PC/2G



PG/3Gd

CURRENT TYPE

DC -

CHEMICAL COMPOSITION (W%), TYPICAL, ALL WELD METAL

C	Mn	Si	P	S	Al	Ti	N
0.30	0.99	0.24	0.013	0.007	1.63	0.003	0.051

MECHANICAL PROPERTIES, TYPICAL, ALL WELD METAL

Condition	Yield strength (N/mm ²)	Tensile strength (N/mm ²)	Elongation (%)	Impact ISO-V(J)
Required: AWS A5.20	not required	480	not required	not required

Typical values AW

525*

* Flat tensile test specimen

PACKAGING AND AVAILABLE SIZES

Diameter (mm)	1.6
22.68 kg coil 50C	X

Innershield® NR® 152: rev. C-EN22-01/02/16

All information in this data sheet is accurate to the best of our knowledge at the time of printing. Please refer to www.lincolnelectric.eu for any updated information.
 Fumes: Safety Data Sheets (SDS) are available on our website.

Innershield® NR® 152

EXAMPLES OF MATERIALS TO BE WELDED

Steel grades/Standard	Type
General structural steels	
EN 10025 part 2	S185, S235, S275, S355
Ship plates	
ASTM A131	Grade A, B, D, AH32 to DH36
Cast steels	
EN 10213-2	GP240R
Pipe material	
EN 10208-1	L210, L240, L290, L360
EN 10208-2	L240, L290, L360
API 5LX	X42, X46, X52
EN 10216-1/	P235T1, P235T2, P275T1
EN 10217-1	P275T2, P355N
Boiler & pressure vessel steels	
EN 10028-2	P235GH, P265GH, P295GH, P355GH
Fine grained steels	
EN 10025 part 3	S275, S355
EN 10025 part 4	S275, S355

CALCULATION DATA

Diameter (mm)	Electrical stick-out (mm)	Wire Feed Speed (cm/min)	Current (A)	Arc Voltage (V)	Deposition rate (kg/h)	kg wire/kg weldmetal
1.6	13	75	90	13	0.55	1.11
		125	150	15	0.9	1.11
		280	250	19	2.0	1.11

WELDING PARAMETERS, OPTIMUM FILL PASSES

Diameter (mm)		Welding positions		
		PA/1G PB/2F	PC/2G	PG/3G down
1.6	Wire feed speed (cm/min)	180	150	200
	Current (A)	205	170	220
	Voltage (V)	16.5	18.5	19.5

REMARKS/APPLICATION ADVICE

Spot welds on 0.75mm to 1.5mm thick material

These procedures include automatic processes where excellent striking is required

Galvanized or zinc coated steel may be welded with Innershield NR-152 at travel speeds of 75 to 100 cm/min. The joint design must permit the zinc oxide vapor to diffuse through the molten puddle or to the atmosphere

Innershield® NR® 203 NiC

CLASSIFICATION

AWS A5.29	E61T8-K6	A-Nr	1
		F-Nr	6
		9606 FM	1

GENERAL DESCRIPTION

Self shielded: easiest equipment arrangement
 All position welding
 Easy to weld in vertical up position
 All passes
 Good impact and CTOD toughness

WELDING POSITIONS (ISO/ASME)



CURRENT TYPE

DC -

APPROVALS

ABS	DNV	LR
3SA	IIIMSH15	3SH15

CHEMICAL COMPOSITION (W%), TYPICAL, ALL WELD METAL

C	Mn	Si	P	S	Ni	Cr	Al	V	Mo
0.06	0.83	0.05	0.004	0.003	0.57	0.08	0.73	<0.1	<0.1

MECHANICAL PROPERTIES, TYPICAL, ALL WELD METAL

	Condition	Yield strength (N/mm ²)	Tensile strength (N/mm ²)	Elongation (%)	Impact ISO-V(J)
					-29°C
Required: AWS A5.29		min. 340	410-550	22	27
Typical values	AW	400	490	29	95

PACKAGING AND AVAILABLE SIZES

Diameter (mm)	2.0
6.35 kg coil 14C	X
22.68 kg coil 50C	X

Innershield® NR® 203 NiC: rev. C-EN22-01/02/16

All information in this data sheet is accurate to the best of our knowledge at the time of printing. Please refer to www.lincolnelectric.eu for any updated information.
 Fumes: Safety Data Sheets (SDS) are available on our website.

Innershield® NR® 203 NiC

EXAMPLES OF MATERIALS TO BE WELDED

Steel grades/Standard	Type
General structural steels	
EN 10025 part 2	S185, S235, S275, S355
Ship plates	
ASTM A131	Grade A, B, D, AH32 to DH36
Cast steels	
EN 10213-2	GP240R
Pipe material	
EN 10208-1	L210, L240, L290, L360
EN 10208-2	L240, L290, L360
API 5LX	X42, X46, X52
EN 10216-1/	P235T1, P235T2, P275T1
EN 10217-1	P275T2, P355N
Boiler & pressure vessel steels	
EN 10028-2	P235GH, P265GH, P295GH, P355GH
Fine grained steels	
EN 10025 part 3	S275, S355
EN 10025 part 4	S275, S355

CALCULATION DATA

Diameter (mm)	Electrical stick-out (mm)	Wire Feed Speed (cm/min)	Current (A)	Arc Voltage (V)	Deposition rate (kg/h)	kg wire/kg weldmetal
2.0	19	125	145	16	1.10	1.32
		230	235	20	1.95	1.32
		280	275	21	2.40	1.32

WELDING PARAMETERS, OPTIMUM FILL PASSES

Diameter (mm)		Welding positions				
		PA/1G PB/2F	PC/2G	PF/3Gup PH/5Gup	PG/3Gdown PJ/5Gdown	PE/4G
2.0	Wire feed speed (cm/min)	280	230	200	200	200
	Current (A)	275	235	215	215	215
	Voltage (V)	21	20	19	18	19

REMARKS/APPLICATION ADVICE

For mild and higher strength steel not exceeding the yield strength range
 Roundabout groove welds, especially for large diameter heavy tubular constructions
 General plate fabrication, including bridge construction, hull plate and stiffener welding on ships and barges, off-shore

Innershield® NR® 203 Ni1

CLASSIFICATION

AWS A5.29	E71T8-Ni1	A-Nr	10
AWS A5.36	E71T8-A2-Ni1-H16	F-Nr	6
EN ISO 17632-A	T 42 4 1Ni Y N 1 H10	9606 FM	1

GENERAL DESCRIPTION

Designed to produce a nickel bearing weld deposit
 Capable of producing weld deposits with impact toughness capable of exceeding 27 J at -29°C
 Color match on weathering steels
 Handles poor fit-up
 Root bead capability

WELDING POSITIONS (ISO/ASME)



PA/1G



PB/2F



PC/2G



PF/3Gu



PG/3Gd



PH/5Gu



PJ/5Gd



PE/4G

CURRENT TYPE

DC -

APPROVALS

ABS	BV	DNV	GL	LR	RINA
3SA,3YSA	SA3YMHH	IIIMSH10	3YSH10	3S,3YSH15	3S,3YS

CHEMICAL COMPOSITION (W%), TYPICAL, ALL WELD METAL

C	Mn	Si	P	S	Ni	Al
0.08	1.1	0.27	0.008	0.003	0.9	0.85

MECHANICAL PROPERTIES, TYPICAL, ALL WELD METAL

	Condition	Yield strength (N/mm ²)	Tensile strength (N/mm ²)	Elongation (%)	Impact ISO-V(J)
					-29°C
Required: AWS A5.29		min. 400	480-620	20	27
Typical values	AW	465	540	26	115

PACKAGING AND AVAILABLE SIZES

Diameter (mm)	2.0	2.4
6.35 kg coil 14C	X	
22.68 kg coil 50C	X	X

Innershield® NR® 203 Ni1: rev. C-EN23-01/02/16

All information in this data sheet is accurate to the best of our knowledge at the time of printing. Please refer to www.lincolnelectric.eu for any updated information.
 Fumes: Safety Data Sheets (SDS) are available on our website.

Innershield® NR® 203 Ni1

EXAMPLES OF MATERIALS TO BE WELDED

Steel grades/Standard	Type
General structural steels	
EN 10025 part 2	S185, S235, S275, S355
Ship plates	
ASTM A131	Grade A, B, D, AH32 to DH36
Cast steels	
EN 10213-2	GP240R
Pipe material	
EN 10208-1	L210, L240, L290, L360
EN 10208-2	L240, L290, L360
API 5LX	X42, X46, X52
EN 10216-1/	P235T1, P235T2, P275T1
EN 10217-1	P275T2, P355N
Boiler & pressure vessel steels	
EN 10028-2	P235GH, P265GH, P295GH, P355GH
Fine grained steels	
EN 10025 part 3	S275, S355
EN 10025 part 4	S275, S355

CALCULATION DATA

Diameter (mm)	Electrical stick-out (mm)	Wire Feed Speed (cm/min)	Current (A)	Arc Voltage (V)	Deposition rate (kg/h)	kg wire/kg weldmetal
2.0	19	125	145	16	1.10	1.30
		230	235	20	1.95	1.30
		355	310	23	3.15	1.30
2.4	19	125	215	18	1.60	1.20
		240	315	21	3.25	1.20
		330	385	24	4.30	1.20

WELDING PARAMETERS, OPTIMUM FILL PASSES

Diameter (mm)		Welding positions						
		PA/1G	PB/2F	PC/2G	PF/3Gup	PH/5Gup	PG/3Gdown PJ/5Gdown	PE/4G
2.0	Wire feed speed (cm/min)	280	330	230	200	200	200	200
	Current (A)	255	300	235	215	215	215	215
	Voltage (V)	21	22	20	19	19	18	19
2.4	Wire feed speed (cm/min)	280	280	215	180			
	Current (A)	345	345	290	250			
	Voltage (V)	22	22	19.5	19			

REMARKS/APPLICATION ADVICE

For mild and higher strength steel, not exceeding the yield strength range of the electrode weld deposit
 General plate fabrication, including bridge construction, hull plate and stiffener welding on ships and barges, offshore
 For semi- and full automatic welding

Innershield® NR® 211 MP

CLASSIFICATION

AWS A5.20	E71T-11	A-Nr	1
AWS A5.36	E71T-11-AZ-CS3	F-Nr	6
EN ISO 17632-A	T 42 Z Z N 1 H10	9606 FM	1

GENERAL DESCRIPTION

Versatile welding capability on a variety of base materials
 High operator appeal and good bead appearance
 Easy slag removal
 Fast freezing characteristics accommodate poor fit-up

WELDING POSITIONS (ISO/ASME)



CURRENT TYPE

DC -

APPROVALS

BV	LR
+	AWS

CHEMICAL COMPOSITION (W%), TYPICAL, ALL WELD METAL

C	Mn	Si	P	S	Al
0.21	0.65	0.25	0.010	0.003	1.3

MECHANICAL PROPERTIES, TYPICAL, ALL WELD METAL

Condition	Yield strength (N/mm ²)	Tensile strength (N/mm ²)	Elongation (%)	Impact ISO-V(J)
Required: AWS A5.20	min. 400	480	20	not required
Typical values	AW 450	610	22	

PACKAGING AND AVAILABLE SIZES

Diameter (mm)	0.9	1.2	1.7	2.0
6.35 kg coil 14C	X	X	X	X
11.34 kg coil 22RR	X	X		
22.68 kg coil 50C			X	X

Innershield® NR® 211 MP: rev. C-EN03-11/05/16

All information in this data sheet is accurate to the best of our knowledge at the time of printing. Please refer to www.lincolnelectric.eu for any updated information.
 Fumes: Safety Data Sheets (SDS) are available on our website.

Innershield® NR® 211 MP

EXAMPLES OF MATERIALS TO BE WELDED

Steel grades/Standard	Type
General structural steels	
EN 10025 part 2	S185, S235, S275, S355
Ship plates	
ASTM A131	Grade A, B, D, AH32 to DH36
Cast steels	
EN 10213-2	GP240R
Pipe material	
EN 10208-1	L210, L240, L290, L360
EN 10208-2	L240, L290, L360
API 5LX	X42, X46, X52
EN 10216-1/	P235T1, P235T2, P275T1
EN 10217-1	P275T2, P355N
Boiler & pressure vessel steels	
EN 10028-2	P235GH, P265GH, P295GH, P355GH
Fine grained steels	
EN 10025 part 3	S275, S355
EN 10025 part 4	S275, S355

CALCULATION DATA

Diameter (mm)	Electrical stick-out (mm)	Wire Feed Speed (cm/min)	Current (A)	Arc Voltage (V)	Deposition rate (kg/h)	kg wire/ kg weldmetal
0.9	10	125	30	14	0.3	1.22
		230	90	16	0.6	1.22
		280	120	16.5	0.8	1.22
1.1	14	180	120	15	0.5	1.22
		280	160	17	1.0	1.22
		330	170	18	1.2	1.22
1.7	19	100	120	15	0.8	1.22
		190	190	18	1.5	1.22
		440	320	23	3.5	1.22
2.0	19	130	180	16	1.4	1.09
		190	250	18	2.2	1.09
		380	350	22	4.3	1.09
2.4	19	130	235	16	2.0	1.10
		140	250	18	2.3	1.10
		250	370	20	4.2	1.10

WELDING PARAMETERS, OPTIMUM FILL PASSES

Diameter (mm)		Welding positions				
		PA/1G PB/2F	PC/2G	PF/3Gup	PG/3Gdown PJ/5Gdown	PE/4G
0.9	Wire feed speed [cm/min]	180	180	150	230	230
	Current (A)	65	65	50	85	85
	Voltage (V)	15	15	14.5	16	16
1.1	Wire feed speed [cm/min]	230	230	200	280	280
	Current (A)	140	140	130	160	160
	Voltage (V)	16	16	16	17	17
1.7	Wire feed speed [cm/min]	440	250	190	300	300
	Current (A)	320	230	190	280	280
	Voltage (V)	23	19.5	18	21	21
2.0	Wire feed speed [cm/min]	330	190	190	230	190
	Current (A)	320	250	320	250	250
	Voltage (V)	21	18	19.5	18	18
2.4	Wire feed speed [cm/min]	230	180	230	140	140
	Current (A)	350	275	350	250	250
	Voltage (V)	19.5	19	19.5	18	18

Innershield® NR® 232

CLASSIFICATION

AWS A5.20	E71T-8	A-Nr	1
AWS A5.36	E71T8-A2-CS3-H16	F-Nr	6
EN ISO 17632-A	T 42 2 Y N 2 H10	9606 FM	1

GENERAL DESCRIPTION

Self shielded: easiest equipment arrangement
 Deposit rate up to 3 kg/h, out of position
 Excellent low temperature impact toughness
 Ideal for fillet welding and filling
 For single and multi-pass welds
 Size diam. 1.7mm suitable for contaminated or primed plate

WELDING POSITIONS (ISO/ASME)



PA/1G



PB/2F



PC/2G



PF/3Gu



PE/4G

CURRENT TYPE

DC -

APPROVALS

ABS	BV	DNV	LR	RINA	TÜV	NKK
3SA,3YSAH15	SA3YMH	IIIVMSH15	3S,3YSH15	3YS	+	KSW53NH10

CHEMICAL COMPOSITION (W%), TYPICAL, ALL WELD METAL

C	Mn	Si	P	S	Al
0.18	0.65	0.27	0.006	0.004	0.55

MECHANICAL PROPERTIES, TYPICAL, ALL WELD METAL

	Condition	Yield strength (N/mm ²)	Tensile strength (N/mm ²)	Elongation (%)	Impact ISO-V(J)	
					-20°C	-29°C
Required: AWS A5.20		min. 400	480	22		27
Typical values	AW	490	590	26	65	35

PACKAGING AND AVAILABLE SIZES

Diameter (mm)	1.7	1.8	2.0
6.12 kg coil 14C	X	X	X
22.68 kg coil 50C	X	X	X

Innershield® NR® 232: rev. C-EN22-01/02/16

All information in this data sheet is accurate to the best of our knowledge at the time of printing. Please refer to www.lincolnelectric.eu for any updated information.
 Fumes: Safety Data Sheets (SDS) are available on our website.

Innershield® NR® 232

EXAMPLES OF MATERIALS TO BE WELDED

Steel grades/Standard	Type
General structural steels	
EN 10025 part 2	S185, S235, S275, S355
Ship plates	
ASTM A131	Grade A, B, D, AH32 to DH36
Cast steels	
EN 10213-2	GP240R
Pipe material	
EN 10208-1	L210, L240, L290, L360
EN 10208-2	L240, L290, L360, L415
API 5LX	X42, X46, X52, X60
EN 10216-1/	P235T1, P235T2, P275T1
EN 10217-1	P275T2, P355N
Boiler & pressure vessel steels	
EN 10028-2	P235GH, P265GH, P295GH, P355GH
Fine grained steels	
EN 10025 part 3	S275, S355, S420
EN 10025 part 4	S275, S355, S420

CALCULATION DATA

Diameter (mm)	Electrical stick-out (mm)	Wire Feed Speed (cm/min)	Current (A)	Arc Voltage (V)	Deposition rate (kg/h)	kg wire/kg weldmetal
1.7	12-25	280	170	19	1.7	1.33
		430	250	21	2.7	1.33
		810	400	26	5.1	1.33
2.0	12-25	200	130	17	1.5	1.22
		430	250	21	2.9	1.22
		730	350	24	5.0	1.22
2.4	12-25	150	130	16	1.3	1.22
		330	250	21	2.8	1.22
		550	350	25	4.6	1.22

WELDING PARAMETERS, OPTIMUM FILL PASSES

Diameter (mm)		Welding positions				
		PA/1G	PB/2F	PC/2G	PF/3Gup	PE/4G
1.7	Wire feed speed (cm/min)	635	495		380	380
	Current (A)	310	275		225	225
	Voltage (V)	23	23		19.5	19.5
1.8	Wire feed speed (cm/min)	635	510	430	390	430
	Current (A)	355	290	255	240	255
	Voltage (V)	11	21	21	20	21
2.0	Wire feed speed (cm/min)	460	380		330	380
	Current (A)	315	285		250	285
	Voltage (V)	23	22		21	22

REMARKS/APPLICATION ADVICE

Designed for the semi-automatic welding of 5mm and thicker steel

Recommended for single and multi-pas welds

Size diam. 1.7mm, is recommended for welds where it is necessary to produce wider passes (weave technique) and for welding plate with contaminations such as oil, rust, paint or primer

Size diam. 1.8mm is recommended to obtain the fastest travel speed on single pass fillet weld

Size diam. 2.0mm is recommended for overhead position

Innershield® NR® 233

CLASSIFICATION

AWS A5.20	E71T-8	A-Nr	1
AWS A5.36	E71T8-A2-CS3-H16	F-Nr	6
EN ISO 17632-A	T 42 3 Y N 2 H10	9606 FM	1

GENERAL DESCRIPTION

Self shielded: easiest equipment arrangement

Due to new production technology and formulation: welder friendly wire with wide range of parameter settings

Forgiving arc, with increased penetration gives better quality welds with great bead appearance

High deposition rate, even in out of position welding

Good impact values

NR-233 has been developed to minimize gas marking, even after the electrode has been exposed to the atmosphere

WELDING POSITIONS (ISO/ASME)



PA/1G



PB/2F



PC/2G



PF/3Gu



PE/4G



PH/5Gu

CURRENT TYPE

DC -

CHEMICAL COMPOSITION (W%), TYPICAL, ALL WELD METAL

C	Mn	Si	P	S	Al
0.16	0.65	0.21	0.010	0.003	0.60

MECHANICAL PROPERTIES, TYPICAL, ALL WELD METAL

	Condition	Yield strength (N/mm ²)	Tensile strength (N/mm ²)	Elongation (%)	Impact ISO-V(J)
					-29°C
Required: AWS A5.20		min. 400	480	22	27
Typical values	AW	440	570	26	40

PACKAGING AND AVAILABLE SIZES

Diameter (mm)	1.6	1.8
5.7 kg plastic spool	X	
11.3 kg plastic spool	X	X

Innershield® NR® 233: rev. C-EN22-01/02/16

All information in this data sheet is accurate to the best of our knowledge at the time of printing. Please refer to www.lincolnelectric.eu for any updated information.
Fumes: Safety Data Sheets (SDS) are available on our website.

Innershield® NR® 233

EXAMPLES OF MATERIALS TO BE WELDED

Steel grades/Standard	Type
General structural steels	
EN 10025 part 2	S185, S235, S275, S355
Ship plates	
ASTM A131	Grade A, B, D, AH32 to DH36
Cast steels	
EN 10213-2	GP240R
Pipe material	
EN 10208-1	L210, L240, L290, L360
EN 10208-2	L240, L290, L360, L415
API 5LX	X42, X46, X52, X60
EN 10216-1/	P235T1, P235T2, P275T1
EN 10217-1	P275T2, P355N
Boiler & pressure vessel steels	
EN 10028-2	P235GH, P265GH, P295GH, P355GH
Fine grained steels	
EN 10025 part 3	S275, S355
EN 10025 part 4	S275, S355

CALCULATION DATA

Diameter (mm)	Electrical stick-out (mm)	Wire Feed Speed (cm/min)	Current (A)	Arc Voltage (V)	Deposition rate (kg/h)	kg wire/ kg weldmetal
1.6	13-32	380	220	17-19	1.9	1.26
		510	245	19-21	2.5	1.31
		640	270	21-23	3.0	1.35
		760	295	23-25	3.5	1.35
		890	315	25-27	4.3	1.31
1.8	19.25	250	185	17-18	1.6	1.25
		380	250	18-19	2.5	1.24
		510	295	20-21	3.2	1.25
		640	330	22-23	4.0	1.26
		760	355	23-24	4.8	1.26

REMARKS/APPLICATION ADVICE

Vertical up fillet and groove welds
Overhead fillet and groove welds
Seismic structural steel erection
General structural steels erection
Ship and barge fabrication

Innershield® NR® 207-H

CLASSIFICATION

AWS A5.29	E71T8-K6	A-Nr	10
		F-Nr	6
		9606 FM	1

GENERAL DESCRIPTION

Self shielded: easiest equipment arrangement
 Vertical down semi-automatic pipe welding
 High quality construction welding in all positions
 Good impact and CTOD toughness
 Low hydrogen weld metal H

WELDING POSITIONS (ISO/ASME)



CURRENT TYPE

DC -

CHEMICAL COMPOSITION (W%), TYPICAL, ALL WELD METAL

C	Mn	Si	P	S	Al	Ni
0.07	0.9	0.2	0.005	0.003	1.0	0.85

MECHANICAL PROPERTIES, TYPICAL, ALL WELD METAL

	Condition	Yield strength (N/mm ²)	Tensile strength (N/mm ²)	Elongation (%)	Impact ISO-V(J)
					-29°C
Required: AWS A5.29		min. 400	480-620	20	27
Typical values	AW	420	535	25	110

PACKAGING AND AVAILABLE SIZES

Diameter (mm)	1.7
6.35 kg coil 14C	X

Innershield® NR® 207-H: rev. C-EN22-01/02/16

All information in this data sheet is accurate to the best of our knowledge at the time of printing. Please refer to www.lincolnelectric.eu for any updated information.
 Fumes: Safety Data Sheets (SDS) are available on our website.

Innershield® NR® 207-H

EXAMPLES OF MATERIALS TO BE WELDED

Steel grades/Standard	Type
General structural steels	
EN 10025 part 2	S185, S235, S275, S355
Ship plates	
ASTM A131	Grade A, B, D, AH32 to DH36
Pipe material	
EN 10208-1	L210, L240, L290, L360
EN 10208-2	L240, L290, L360, L415
API 5LX	X42, X46, X52, X60
EN 10216-1/	P235T1, P235T2, P275T1
EN 10217-1	P275T2, P355N
Fine grained steels	
EN 10025 part 3	S275, S355
EN 10025 part 4	S275, S355

CALCULATION DATA

Diameter (mm)	Electrical stick-out (mm)	Wire Feed Speed (cm/min)	Current (A)	Arc Voltage (V)	Deposition rate (kg/h)	kg wire/ kg weldmetal
1.7	19	230	205	17.5	1.5	-
		270	220	18.5	1.8	-
		300	245	19.5	2.0	-

REMARKS/APPLICATION ADVICE

- Where low hydrogen weld metal is required
- High productivity welding
- Where arctic mechanical properties are required in general construction welding
- Semi-automatic pipe welding

Innershield® NR® 208-H

CLASSIFICATION

AWS A5.29	E91T8-G	A-Nr	1
		F-Nr	6
		9606 FM	2

GENERAL DESCRIPTION

Self shielded: easiest equipment arrangement
 Semi-automatic fill and cap pass welding of X-80 pipe steel in vertical down position
 Excellent low temperature toughness
 Low hydrogen content (HDM < 8 ml/100g)

WELDING POSITIONS (ISO/ASME)



P/J5Gd

CURRENT TYPE

DC -

APPROVALS

TÜV

+

CHEMICAL COMPOSITION (W%), TYPICAL, ALL WELD METAL

C	Mn	Si	P	S	Al	Ni
0.05	1.65	0.25	0.007	<0.003	0.85	0.8

MECHANICAL PROPERTIES, TYPICAL, ALL WELD METAL

	Condition	Yield strength (N/mm ²)	Tensile strength (N/mm ²)	Elongation (%)	Impact ISO-V(J)
					-30°C
Required: AWS A5.29		min. 540	620-760	17	
Typical values	AW (IG)	585	650	26	115

PACKAGING AND AVAILABLE SIZES

Diameter (mm)	1.7	2.0
6.35 kg coil 14C	X	X

Innershield® NR® 208-H.rev. C-EN22-01/02/16

All information in this data sheet is accurate to the best of our knowledge at the time of printing. Please refer to www.lincolnelectric.eu for any updated information.
 Fumes: Safety Data Sheets (SDS) are available on our website.

Innershield® NR® 208-H

EXAMPLES OF MATERIALS TO BE WELDED

Steel grades/Standard	Type
Pipe material	
API 5LX	X60, X70
EN 10208-2	L 415, L445, L480, L550

CALCULATION DATA

Diameter (mm)	Electrical stick-out (mm)	Wire Feed Speed (cm/min)	Current (A)	Arc Voltage (V)	Deposition rate (kg/h)	kg wire/ kg weldmetal
1.7	19	150	145	15.5	1.0	-
		205	180	17.5	1.3	-
		270	215	18.5	1.8	-
		370	255	20.5	2.4	-

REMARKS/APPLICATION ADVICE

Preheat and interpass temperature depending on steel quality
For root pass welding of X-60 to X-80 the Innershield NR-204-H electrode is recommended

Innershield® NR® 305

CLASSIFICATION

AWS A5.20	E70T-6	A-Nr	1
AWS A5.36	E70T6-A2-CS3-H16	F-Nr	6
EN ISO 17632-A	T 42 0 W N 3 H15	9606 FM	1

GENERAL DESCRIPTION

NR-305 is a self-shielded flux cored wire

Not intended for out-of-position welding, but can be used on 15° max. downhill and 5° max. uphill applications

High deposit rates and fast travel speed

Easy handling

Recommended for maximum productivity, downhand welding

WELDING POSITIONS (ISO/ASME)



PA/1G PB/2F

CURRENT TYPE

DC -

APPROVALS

ABS	BV	DNV
2SA,2YSA	SA2YMH	IYMS

CHEMICAL COMPOSITION (W%), TYPICAL, ALL WELD METAL

C	Mn	Si	P	S	Al
0.09	0.9	0.2	0.007	0.008	0.80

MECHANICAL PROPERTIES, TYPICAL, ALL WELD METAL

Condition	Yield strength (N/mm ²)	Tensile strength (N/mm ²)	Elongation (%)	Impact ISO-V(J)
				-29°C
Required: AWS A5.20	min. 400	480	22	27
Typical values AW	470	550	25	40

PACKAGING AND AVAILABLE SIZES

Diameter (mm)	1.7	2.0	2.4
22.68 kg coil 50C	X	X	X

Innershield® NR® 305: rev. C-EN22-01/02/16

All information in this data sheet is accurate to the best of our knowledge at the time of printing. Please refer to www.lincolnelectric.eu for any updated information.
Fumes: Safety Data Sheets (SDS) are available on our website.

Innershield® NR® 305

EXAMPLES OF MATERIALS TO BE WELDED

Steel grades/Standard	Type
General structural steels	
EN 10025 part 2	S185, S235, S275, S355
Ship plates	
ASTM A131	Grade A, B, D, AH32 to DH36
Cast steels	
EN 10213-2	GP240R
Pipe material	
EN 10208-1	L210, L240, L290, L360
EN 10208-2	L240, L290, L360, L415
API 5LX	X42, X46, X52, X60
EN 10216-1/	P235T1, P235T2, P275T1
EN 10217-1	P275T2, P355N
Boiler & pressure vessel steels	
EN 10028-2	P235GH, P265GH, P295GH, P355GH
Fine grained steels	
EN 10025 part 3	S275, S355, S420
EN 10025 part 4	S275, S355, S420

CALCULATION DATA

Diameter (mm)	Electrical stick-out (mm)	Wire Feed Speed (cm/min)	Current [A]	Arc Voltage [V]	Deposition rate (kg/h)	kg wire/kg weldmetal
1.7	12-25	510	275	24	3.75	1.22
		635	325	25	4.60	1.22
		890	390	27	6.35	1.22
2.0	19-25	510	360	22.5	4.50	1.22
		635	410	25	5.90	1.22
		1140	545	32.5	11.10	1.22
2.4	38-65	405	330	21	5.00	1.23
		610	425	24	7.55	1.23
		1015	525	33	12.70	1.23

WELDING PARAMETERS, OPTIMUM FILL PASSES

Diameter (mm)		Welding positions	
		PA/1G	PB/2F
1.7	Wire feed speed (cm/min)	635	635
	Voltage (V)	25	25
2.0	Wire feed speed (cm/min)	890	635
	Voltage (V)	25	24
2.4	Wire feed speed (cm/min)	710	610
	Voltage (V)	27	24

REMARKS/APPLICATION ADVICE

Typical applications include bridge, ship, barge or offshore drilling rig construction and machinery, structural and general fabrication.

NR-305 can be used for single and multiple pass fillet and lap welds and for deep groove butt welds in the flat position.

Innershield® NR® 311

CLASSIFICATION

AWS A5.20	E70T-7	A-Nr	1
AWS A5.36	E70T7-AZ-CS3	F-Nr	6
		9606 FM	1

GENERAL DESCRIPTION

Self shielded: easiest equipment arrangement
 Good penetration, as in column butt welds and narrow gap welds
 Fast travel speed
 High deposition rates

WELDING POSITIONS (ISO/ASME)



PA/1G



PB/2F



PC/2G



PG/3Gd

CURRENT TYPE

DC -

CHEMICAL COMPOSITION (W%), TYPICAL, ALL WELD METAL

C	Mn	Si	P	S	Al
0.27	0.4	0.08	0.007	0.005	1.5

MECHANICAL PROPERTIES, TYPICAL, ALL WELD METAL

Condition	Yield strength (N/mm ²)	Tensile strength (N/mm ²)	Elongation (%)
Required: AWS A5.20	min. 400	480	22
Typical values	AW 430	590	24

PACKAGING AND AVAILABLE SIZES

Diameter (mm)	2.0	2.4
6.35 kg coil 14C	X	
22.68 kg coil 50C		X

Innershield® NR® 311: rev. C-ENZ2-01/02/16

All information in this data sheet is accurate to the best of our knowledge at the time of printing. Please refer to www.lincolnelectric.eu for any updated information.
 Fumes: Safety Data Sheets (SDS) are available on our website.

Innershield® NR® 311

EXAMPLES OF MATERIALS TO BE WELDED

Steel grades/Standard	Type
General structural steels	
EN 10025 part 2	S185, S235, S275, S355
Ship plates	
ASTM A131	Grade A, B, D, AH32 to DH36
Cast steels	
EN 10213-2	GP240R
Pipe material	
EN 10208-1	L210, L240, L290, L360
EN 10208-2	L240, L290, L360, L415
API 5LX	X42, X46, X52, X60
EN 10216-1/	P235T1, P235T2, P275T1
EN 10217-1	P275T2, P355N
Boiler & pressure vessel steels	
EN 10028-2	P235GH, P265GH, P295GH, P355GH
Fine grained steels	
EN 10025 part 3	S275, S355, S420

CALCULATION DATA

Diameter (mm)	Electrical stick-out (mm)	Wire Feed Speed (cm/min)	Current (A)	Arc Voltage (V)	Deposition rate (kg/h)	kg wire/kg weldmetal
2.0	32	255	190	21	2.2	1.28
		405	275	25	3.6	1.28
		760	410	28	7.1	1.28

WELDING PARAMETERS, OPTIMUM FILL PASSES

Diameter (mm)		Welding positions			
		PA/1G	PB/2F	PC/2G	PG/3G down
2.0	Wire feed speed (cm/min)	610	510	410	380
	Current (A)	355	320	280	260
	Voltage (V)	26	26	25	25

FCAW

REMARKS/APPLICATION ADVICE

Horizontal butt welds such as column structural connections.

Fillet and lap welds in the flat horizontal and downhill positions.

Deep groove welds. The penetration and extremely easy slag removal permit using a narrow gap and small bevel angle to minimize the total Flow rate of weld metal needed to fill the joint.

Innershield® NR® 400

CLASSIFICATION

AWS A5.29	E71T8-K6	A-Nr	10
EN ISO 17632-A	T 42 6 1Ni Y N 2 H10	F-Nr	6
		9606 FM	1

GENERAL DESCRIPTION

Self shielding: easiest equipment arrangement
 Higher strength level, overmatching StE 355
 Excellent impact toughness at -40°C
 CTOD tested, offshore constructions
 All positions, all passes

WELDING POSITIONS (ISO/ASME)



PA/1G



PB/2F



PC/2G



PF/3Gu



PE/4G



PH/5Gu

CURRENT TYPE

DC -

APPROVALS

BV	LR	TÜV
SA3YMHH	3S,3YSH15	+

CHEMICAL COMPOSITION (W%), TYPICAL, ALL WELD METAL

C	Mn	Si	P	S	Al	Ni	Cr
0.06	0.74	0.17	0.004	0.002	0.74	0.75	0.13

MECHANICAL PROPERTIES, TYPICAL, ALL WELD METAL

	Condition	Yield strength (N/mm ²)	Tensile strength (N/mm ²)	Elongation (%)	Impact ISO-V(J)
					-60°C
Required: AWS A5.29		min. 400	480-620	20	27
Typical values	AW	435	525	26	100

PACKAGING AND AVAILABLE SIZES

Diameter (mm)	2.0
6.35 kg coil 14C	X
22.68 kg coil 50C	

Innershield® NR® 400: rev. C-EN24-01/02/16

All information in this data sheet is accurate to the best of our knowledge at the time of printing. Please refer to www.lincolnelectric.eu for any updated information.
 Fumes: Safety Data Sheets (SDS) are available on our website.

Innershield® NR® 400

EXAMPLES OF MATERIALS TO BE WELDED

Steel grades/Standard	Type
General structural steels	
EN 10025 part 2	S185, S235, S275, S355
Ship plates	
ASTM A131	Grade A, B, D, AH32 to DH36
Cast steels	
EN 10213-2	GP240R
Pipe material	
EN 10208-1	L210, L240, L290, L360
EN 10208-2	L240, L290, L360
API 5LX	X42, X46, X52
EN 10216-1/	P235T1, P235T2, P275T1
EN 10217-1	P275T2, P355N
Boiler & pressure vessel steels	
EN 10028-2	P235GH, P265GH, P295GH, P355GH
Fine grained steels	
EN 10025 part 3	S275, S355
EN 10025 part 4	S275, S355

CALCULATION DATA

Diameter (mm)	Electrical stick-out (mm)	Wire Feed Speed (cm/min)	Current (A)	Arc Voltage (V)	Deposition rate (kg/h)	kg wire/kg weldmetal
2.0	19	150	150	16.5	1.20	1.37
		230	225	19.5	1.85	1.37
		280	265	20.5	2.35	1.37

WELDING PARAMETERS, OPTIMUM FILL PASSES

Diameter (mm)		Welding positions			
		PA/1G PB/2F	PC/2G	PF/3G up PF/5G up	PE/4G
2.0	Wire feed speed (cm/min)	280	230	200	200
	Current (A)	265	225	190	190
	Voltage (V)	20	19	18	18

REMARKS/APPLICATION ADVICE

Off-shore oil equipment, piping, storage tanks
 General plate fabrication including bridge construction on ships and barges
 Circumferential groove welds for heavy wall, large diameter tubular construction

Innershield® NS® 3M

CLASSIFICATION

AWS A5.20	E70T-4	A-Nr	1
AWS A5.36	E70T4-AZ-CS3	F-Nr	6
EN ISO 17632-A	T 46 Z V N 3	9606 FM	1/2

GENERAL DESCRIPTION

NS-3ME is a self shielded wire for high deposition rate flat and horizontal welding where impact properties are not required
 Recommended for heavy sections or crack-sensitive applications
 Can be used for rail joint welding

WELDING POSITIONS (ISO/ASME)



PA/1G



PB/2F

CURRENT TYPE

DC +

CHEMICAL COMPOSITION (W%), TYPICAL, ALL WELD METAL

C	Mn	Si	P	S	Al
0.23	0.45	0.25	0.006	0.006	1.40

MECHANICAL PROPERTIES, TYPICAL, ALL WELD METAL

	Condition	Yield strength (N/mm ²)	Tensile strength (N/mm ²)	Elongation (%)
Required: AWS A5.20		460	530-670	22
Typical values	AW	470	640	27

PACKAGING AND AVAILABLE SIZES

Diameter (mm)	2.0	2.4	3.0
6.35 kg coil 14C	X		
12.5 kg coil 25RR	X		
22.68 kg coil 50C	X	X	X

Innershield® NS® 3M; rev. C-EN23-11/05/16

All information in this data sheet is accurate to the best of our knowledge at the time of printing. Please refer to www.lincolnelectric.eu for any updated information.
 Fumes: Safety Data Sheets (SDS) are available on our website.

Innershield® NS® 3M

EXAMPLES OF MATERIALS TO BE WELDED

Steel grades/Standard	Type
General structural steels	
EN 10025 part 2	S185, S235, S275, S355
Ship plates	
ASTM A131	Grade A, B, D, AH32 to DH36
Cast steels	
EN 10213-2	GP240R
Pipe material	
EN 10208-1	L210, L240, L290, L360
EN 10208-2	L240, L290, L360, L415
API 5LX	X42, X46, X52, X60
EN 10216-1/	P235T1, P235T2, P275T1
EN 10217-1	P275T2, P355N
Fine grained steels	
EN 10025 part 3	S275, S355, S420
EN 10025 part 4	S275, S355, S420

CALCULATION DATA

Diameter (mm)	Electrical stick-out (mm)	Wire Feed Speed (cm/min)	Current (A)	Arc Voltage (V)	Deposition rate (kg/h)	kg wire/kg weldmetal
2.0	50	500	250	29	5.0	1.18
		635	290	30	6.3	1.18
		760	320	31	7.6	1.18
2.4	70	280	250	28	3.8	1.16
		580	400	31	8.1	1.16
		700	450	32	10.0	1.16
3.0	70	380	400	28	7.7	1.23
		450	450	29	9.0	1.23
		570	550	31	12.0	1.23

WELDING PARAMETERS, OPTIMUM FILL PASSES

Diameter (mm)		Welding positions	
		PA/1G	PB/2F
2.0	Wire feed speed (cm/min)	635	635
	Current (A)	290	290
	Voltage (V)	30	30
2.4	Wire feed speed (cm/min)	580	580
	Current (A)	400	400
	Voltage (V)	31	31
3.0*	Wire feed speed (cm/min)	440	440
	Current (A)	445	445
	Voltage (V)	29	29
3.0**	Wire feed speed (cm/min)	760	
	Current (A)	550	
	Voltage (V)	37	

* Stick-out 70mm - ** Stick-out 95mm

REMARKS/APPLICATION ADVICE

Multi-pass fillet and lap welds.

Single passes 4.5 to 9mm fillet and lap welds (1F).

Crack resistant fillets on higher strength steels where required joint strength can be obtained by using the proper fillet size.

Joint welding of rail steel profiles with placed copperbacking.

Cor-A-Rosta® 304L

CLASSIFICATION

AWS A5.22	E308LT0-1/-4	A-Nr	8	Mat-Nr	1.4316
ISO 17633-A	T 19 9 L R C/M 3	F-Nr	6		
		9606 FM	5		

GENERAL DESCRIPTION

Gas shielded flux cored stainless steel wire electrode for downhand welding
 Stable arc, low spatter and good slag removal
 Excellent wire feeding and operator appeal
 Bright appearance of weld metal

WELDING POSITIONS (ISO/ASME)



CURRENT TYPE / SHIELDING GAS (ISO 14175)

DC +
 M21 : Mixed gas Ar+ (>15-25%) CO₂
 C1 : Active gas 100% CO₂
 Flow rate : 15-25 l/min

APPROVALS

Shielding gas	DNV	LRS	TÜV
M21	+		+
C1	+	+	

CHEMICAL COMPOSITION (W%), TYPICAL, ALL WELD METAL

Shielding gas	C	Mn	Si	Cr	Ni	FN [acc.WRC 1992]
M21 /C1	0.03	1.3	0.7	19.5	10	8

MECHANICAL PROPERTIES, TYPICAL, ALL WELD METAL

	Shielding gas	Condition	Yield strength [N/mm ²]	Tensile strength [N/mm ²]	Elongation [%]	Impact ISO-V(J)	
						+20°C	-110°C
Required: AWS A5.22 ISO 17633-A Typical values	M21/C1	AW	not required min. 320 400	min. 520 min. 510 560	min. 35 min. 30 42	80	40

PACKAGING AND AVAILABLE SIZES

Diameter [mm]	1.2
15 kg spool S300	X

Cor-A-Rosta® 304L : rev. C-EN28-19/05/16

Cor-A-Rosta® 304L

EXAMPLES OF EXAMPLES OF MATERIALS TO BE WELDED

Steel grades	EN 10088-1/-2	EN 10213-4	Mat. Nr	ASTM/ACI A240/A312/A351	UNS
Extra low carbon [C <0.03%]					
	X2CrNi19-11		1.4306	(TP)304L CF-3	S30403 J92500
	X2CrNi18-10		1.4311	(TP)304LN 302,304	S30453 S30400
Medium carbon [C >0.03%]					
	X4CrNi18-10		1.4301	(TP)304	S30409
		G-X5CrNi19-10	1.4308	CF 8	J92600
Ti-, Nb stabilized					
	X6CrNiTi18-10		1.4541	(TP)321 (TP)321H	S32100 S32109
	X6CrNiNb18-10		1.4550	(TP)347 (TP)347H	S34700 S34709
		G-X5CrNiNb19-10	1.4552	CF-8C	J92710

WELDING PARAMETERS, OPTIMUM FILL PASSES

Diameter (mm)	Welding positions		
	PA/1G	PB/2F	PC/2G
1.2	100-250A	100-250A	100-200A

REMARKS/APPLICATION ADVICE

For positional welding, use Cor-A-Rosta P304L

FCAW

Cor-A-Rosta® P304L

CLASSIFICATION

AWS A5.22	E308LT1-1/-4	A-Nr	8	Mat-Nr	1.4316
ISO 17633-A	T 19 9 L P C/M 2	F-Nr	6		
		9606 FM	5		

GENERAL DESCRIPTION

Gas shielded flux cored stainless steel wire electrode for positional welding
 Stable arc, low spatter and good slag removal
 Excellent wire feeding and operator appeal
 Bright appearance of weld metal

WELDING POSITIONS (ISO/ASME)



PA/1G

PB/2F

PC/2G

PF/3Gu

PE/4G

CURRENT TYPE / SHIELDING GAS (ISO 14175)

DC +
 M21 : Mixed gas Ar+ (>15-25%) CO₂
 C1 : Active gas 100% CO₂
 Flow rate : 15-25 l/min

APPROVALS

Shielding gas **TÜV**
 M21 +

CHEMICAL COMPOSITION (W%), TYPICAL, ALL WELD METAL

Shielding gas	C	Mn	Si	Cr	Ni	FN [acc.WRC 1992]
M21 /C1	0.03	1.3	0.7	19.5	10	8

MECHANICAL PROPERTIES, TYPICAL, ALL WELD METAL

	Shielding gas	Condition	Yield strength (N/mm ²)	Tensile strength (N/mm ²)	Elongation (%)	Impact ISO-V(J)	
						+20°C	-110°C
Required: AWS A5.22 ISO 17633-A Typical values	M21/C1	AW	not required min. 320 400	min.520 min. 510 560	min. 35 min. 30 42	80	40

PACKAGING AND AVAILABLE SIZES

Diameter (mm)	1.2
15 kg spool S300	X

Cor-A-Rosta® P304L : rev. C-EN26-19/05/16

All information in this data sheet is accurate to the best of our knowledge at the time of printing. Please refer to www.lincolnelectric.eu for any updated information.
 Fumes: Safety Data Sheets (SDS) are available on our website.

Cor-A-Rosta® P304L

EXAMPLES OF MATERIALS TO BE WELDED

Steel grades	EN 10088-1/-2	EN 10213-4	Mat. Nr	ASTM/ACI A240/A312/A351	UNS
Extra low carbon [C <0.03%]					
	X2CrNi19-11		1.4306	(TP)304L CF-3	S30403 J92500
	X2CrNi18-10		1.4311	(TP)304LN 302,304	S30453 S30400
Medium carbon [C >0.03%]					
	X4CrNi18-10		1.4301	(TP)304	S30409
		G-X5CrNi19-10	1.4308	CF 8	J92600
Ti-, Nb stabilized					
	X6CrNiTi18-10		1.4541	(TP)321 (TP)321H	S32100 S32109
	X6CrNiNb18-10		1.4550	(TP)347 (TP)347H	S34700 S34709
		G-X5CrNiNb19-10	1.4552	CF-8C	J92710

WELDING PARAMETERS, OPTIMUM FILL PASSES

Diameter (mm)	Welding positions			
	PA/1G	PB/2F	PC/2G	PF/3G up
1.2	100-250A	100-250A	100-200A	100-180A

REMARKS/APPLICATION ADVICE

For downhand welding, use Cor-A-Rosta 304L

Cor-A-Rosta® 347

CLASSIFICATION

AWS A5.22	E347T0-1/4	A-Nr	8	Mat-Nr	1.4551
ISO 17633-A	T 19 9 Nb R C/M 3	F-Nr	6		
		9606 FM	5		

GENERAL DESCRIPTION

Rutile gas shielded stainless steel wire electrode for downhand welding
 For Ti or Nb stabilized 304 or equivalent steels
 Excellent resistance in oxidizing environments such as nitric acid
 High resistance to intergranular corrosion
 Easy slag release and smooth bead appearance

WELDING POSITIONS (ISO/ASME)



PA/1G



PB/2F



PC/2G

CURRENT TYPE / SHIELDING GAS (ISO 14175)

DC +
 M21 : Mixed gas Ar+ (>15-25%) CO₂
 C1 : Active gas 100% CO₂
 Flow rate: 15-25 l/min

CHEMICAL COMPOSITION (W%), TYPICAL, ALL WELD METAL

Shielding gas	C	Mn	Si	Cr	Ni	Nb	FN [acc.WRC 1992]
M21	0.05	1.4	0.6	19.5	10	0.5	5

MECHANICAL PROPERTIES, TYPICAL, ALL WELD METAL

	Shielding gas	Condition	Yield strength [N/mm ²]	Tensile strength [N/mm ²]	Elongation [%]	Impact ISO-V(I) +20°C
Required: AWS A5.22 ISO 17633-A			not required	min.520	min. 30	
Typical values	M21	AW	min. 350 435	min. 550 600	min. 25 42	90

PACKAGING AND AVAILABLE SIZES

Diameter (mm)	1.2
15 kg spool S300	X

Cor-A-Rosta® 347: rev.C-EN26-01/02/16

Cor-A-Rosta® 347

EXAMPLES OF MATERIALS TO BE WELDED

Steel grades	EN 10088-1/-2	EN 10213-4	Mat. Nr	ASTM/ACI A240/A312/A351	UNS
Ti-, Nb stabilized					
	X6CrNiTi18-10		1.4541	(TP)321 (TP)321H	S32100 S32109
	X6CrNiNb18-10		1.4550	(TP)347 (TP)347H	S34700 S34709
		G-X5CrNiNb19-10	1.4552	CF-8C	J92710
Non stabilized					
	X4CrNi18-10		1.4301	302 (TP)304	S30400
	X2CrNi19-11		1.4306	(TP)304L	S30403
		G-X5CrNi19-10	1.4308	CF-8	J92600
			1.4312	(TP)304H	S30409

WELDING PARAMETERS, OPTIMUM FILL PASSES

Diameter (mm)	Welding positions		
	PA/1G	PB/2F	PC/2G
1.2	100-250A	100-250A	100-200A

FCAW

Cor-A-Rosta® 316L

CLASSIFICATION

AWS A5.22	E316LT0-1/ -4	A-Nr	8	Mat-Nr	1.4430
ISO 17633-A	T 19 12 3 L R C/M 3	F-Nr	6		
		9606 FM	5		

GENERAL DESCRIPTION

Gas shielded flux cored stainless steel wire electrode for downhand welding
 Stable arc, low spatter and good slag removal
 Excellent wire feeding and operator appeal
 Bright appearance of weld metal

WELDING POSITIONS (ISO/ASME)



PA/1G PB/2F PC/2G

CURRENT TYPE / SHIELDING GAS (ISO 14175)

DC +
 M21 : Mixed gas Ar+ (>15-25%) CO₂
 C1 : Active gas 100% CO₂
 Flow rate: 15-25 l/min

APPROVALS

Shielding gas	LRS	TÜV
M21	+	+
C1	+	

CHEMICAL COMPOSITION (W%), TYPICAL, ALL WELD METAL

Shielding gas	C	Mn	Si	Cr	Ni	Mo	FN (acc.WRC 1992)
M21 /C1	0.03	1.3	0.5	19	12	2.7	8

MECHANICAL PROPERTIES, TYPICAL, ALL WELD METAL

	Shielding gas	Condition	Yield strength [N/mm ²]	Tensile strength [N/mm ²]	Elongation [%]	Impact ISO-V(J)	
						+20°C	-110°C
Required: AWS A5.22 ISO 17633-A	M21/C1	AW	not required	min. 485	min. 30	70	40
Typical values			min. 320 440	min. 510 580	min. 25 38		

PACKAGING AND AVAILABLE SIZES

Diameter (mm)	1.2
15 kg spool S300	X

Cor-A-Rosta® 316L : rev. C-EN27-19/05/16

Cor-A-Rosta® 316L

EXAMPLES OF MATERIALS TO BE WELDED

Steel grades	EN 10088-1/-2	EN 10213-4	Mat. Nr	ASTM/ACI A240/A312/A351	UNS
Extra low carbon [C <0.03%]					
	X2CrNiMo17-12-2		1.4404	(TP)316L CF-3M	S31603 J92800
	X2CrNiMo18-14-3		1.4435	(TP)316L	S31603
	X2CrNiMoN17-11-2		1.4406	(TP)316LN	S31653
	X2CrNiMoN17-13-3		1.4429		
Medium carbon [C >0.03%]					
	X4CrNiMo17-12-2		1.4401	(TP)316	S31600
	X4CrNiMo17-13-3		1.4436		
		G-X5CrNiMo19-11	1.4408	CF 8M	J92900
Ti-, Nb stabilized					
	X6CrNiMoTi17-12-2		1.4571	316Ti	S31635
	X6CrNiMoNb17-12-2		1.4580	316Cb	S31640
		G-X5CrNiNb19-10	1.4552	CF-8C	J92710

WELDING PARAMETERS, OPTIMUM FILL PASSES

Diameter (mm)	Welding positions	
	PA/1G	PB/2F
1.2	100-250A	100-250A

REMARKS/APPLICATION ADVICE

For positional welding, use Cor-A-Rosta P316L

FCAW

Cor-A-Rosta® P316L

CLASSIFICATION

AWS A5.22	E316LT1-1/-4	A-Nr	8	Mat-Nr	1.4430
ISO 17633-A	T 19 12 3 L P C/M 2	F-Nr	6		
		9606 FM	5		

GENERAL DESCRIPTION

Gas shielded flux cored stainless steel wire electrode for positional welding
 Stable arc, low spatter and good slag removal
 Excellent wire feeding and operator appeal
 Bright appearance of weld metal

WELDING POSITIONS (ISO/ASME)



CURRENT TYPE / SHIELDING GAS (ISO 14175)

DC +
 M21 : Mixed gas Ar+ (>15-25%) CO₂
 C1 : Active gas 100% CO₂
 Flow rate: 15-25 l/min

APPROVALS

Shielding gas	ABS	DNV	TÜV
M21	+	+	+
C1	+	+	

CHEMICAL COMPOSITION (W%), TYPICAL, ALL WELD METAL

Shielding gas	C	Mn	Si	Cr	Ni	Mo	FN (acc.WRC 1992)
M21 /C1	0.03	1.3	0.5	19	12	2.7	6

MECHANICAL PROPERTIES, TYPICAL, ALL WELD METAL

	Shielding gas	Condition	Yield strength [N/mm ²]	Tensile strength [N/mm ²]	Elongation [%]	Impact ISO-V(J)	
						+20°C	-110°C
Required: AWS A5.22 ISO 17633-A Typical values	M21/C1	AW	not required min. 320 440	min. 485 min. 510 580	min. 30 min. 25 38	70	40

PACKAGING AND AVAILABLE SIZES

Diameter (mm)	1.2
5 kg plastic spool S200	X
15 kg spool S300	X

Cor-A-Rosta® P316L : rev. C-EN26-19/05/16

Cor-A-Rosta® P316L

EXAMPLES OF MATERIALS TO BE WELDED

Steel grades	EN 10088-1/-2	EN 10213-4	Mat. Nr	ASTM/ACI A240/A312/A351	UNS
Extra low carbon [C <0.03%]					
	X2CrNiMo17-12-2		1.4404	(TP)316L CF-3M	S31603 J92800
	X2CrNiMo18-14-3		1.4435	(TP)316L	S31603
	X2CrNiMoN17-11-2		1.4406	(TP)316LN	S31653
	X2CrNiMoN17-13-3		1.4429		
Medium carbon [C >0.03%]					
	X4CrNiMo17-12-2		1.4401	(TP)316	S31600
	X4CrNiMo17-13-3		1.4436		
		G-X5CrNiMo19-11	1.4408	CF 8M	J92900
Ti-, Nb stabilized					
	X6CrNiMoTi17-12-2		1.4571	316Ti	S31635
	X6CrNiMoNb17-12-2		1.4580	316Cb	S31640
		G-X5CrNiNb19-10	1.4552	CF-8C	J92710

WELDING PARAMETERS, OPTIMUM FILL PASSES

Diameter (mm)	Welding positions			
	PA/1G	PB/2F	PC/2G	PF/3G up
1.2	100-250A	100-250A	100-200A	100-200A

FCAW

REMARKS/APPLICATION ADVICE

For downhand welding, use Cor-A-Rosta 316L

Cor-A-Rosta® 309L

CLASSIFICATION

AWS A5.22	E309LT0-1/-4	A-Nr	8	Mat-Nr	1.4332
ISO 17633-A	T 23 12 L R C/M 3	F-Nr	6		
		9606 FM	5		

GENERAL DESCRIPTION

Gas shielded flux cored high CrNi alloyed wire electrode for downhand welding
 For welding stainless to mild steel and buffer layers in clad steel
 Excellent weldability and self releasing slag
 High resistance to embrittlement

WELDING POSITIONS (ISO/ASME)



PA/1G PB/2F PC/2G

CURRENT TYPE / SHIELDING GAS (ISO 14175)

DC +
 M21 : Mixed gas Ar+ (>15-25%) CO₂
 C1 : Active gas 100% CO₂
 Flow rate: 15-25 l/min

APPROVALS

Shielding gas	LRS	TÜV
M21	+	+
C1	+	

CHEMICAL COMPOSITION (W%), TYPICAL, ALL WELD METAL

Shielding gas	C	Mn	Si	Cr	Ni	FN (acc.WRC 1992)
M21/C1	0.03	1.4	0.6	24	12.5	15

MECHANICAL PROPERTIES, TYPICAL, ALL WELD METAL

	Shielding gas	Condition	Yield strength [N/mm ²]	Tensile strength [N/mm ²]	Elongation [%]	Impact ISO-V(J)	
						+20°C	-20°C
Required: AWS A5.22 ISO 17633-A			not required	min. 520	min. 30		
Typical values	M21/C1	AW	min. 320 445	min. 510 560	min. 25 36	45	40

PACKAGING AND AVAILABLE SIZES

Diameter (mm)	1.2
5 kg plastic spool S200	X
15 kg spool S300	X

Cor-A-Rosta® 309L : rev.C-EN29-19/05/16

Cor-A-Rosta® 309L

EXAMPLES OF MATERIALS TO BE WELDED

Steel grades	EN 10088-1/-2	Mat. Nr	ASTM/ACI A240/A312/A351	UNS
Corrosion resistant cladsteels				
	X2CrNiN18-10	1.4311	[TP]304LN	S30453
	X2CrNi19-11	1.4306	[TP]304L	S30403
			CF-3	J92500
	X4CrNi 18-10	1.4301	[TP]304	S30400

Dissimilar metals (mild and low alloy steel to CrNi or CrNiMo stainless steel)

WELDING PARAMETERS, OPTIMUM FILL PASSES

Diameter (mm)	Welding positions		
	PA/1G	PB/2F	PC/G
1.2	100-250A	100-250A	100-200A

REMARKS/APPLICATION ADVICE

For positional welding, use Cor-A-Rosta P309L

FCAW

Cor-A-Rosta® P309L

CLASSIFICATION

AWS A5.22	E309LT1-1/-4	A-Nr	8	Mat-Nr	1.4332
ISO 17633-A	T 23 12 L P C/M 2	F-Nr	6		
		9606 FM	5		

GENERAL DESCRIPTION

Gas shielded flux cored high CrNi alloyed wire electrode for positional welding
 For welding stainless to mild steel and buffer layers in clad steel
 Excellent weldability and self releasing slag
 High resistance to embrittlement

WELDING POSITIONS (ISO/ASME)



CURRENT TYPE / SHIELDING GAS (ISO 14175)

DC +
 M21 : Mixed gas Ar+ (>15-25%) CO₂
 C1 : Active gas 100% CO₂
 Flow rate: 15-25 l/min

APPROVALS

Shielding gas	ABS	DNV	LRS	TÜV
M21	+	+	+	+
C1	+	+	+	

CHEMICAL COMPOSITION (W%), TYPICAL, ALL WELD METAL

Shielding gas	C	Mn	Si	Cr	Ni	FN (acc.WRC 1992)
M21 /C1	0.04	1.3	0.6	24	12.5	15

MECHANICAL PROPERTIES, TYPICAL, ALL WELD METAL

	Shielding gas	Condition	Yield strength [N/mm ²]	Tensile strength [N/mm ²]	Elongation [%]	Impact ISO-V(J)	
						+20°C	-20°C
Required: AWS A5.22 ISO 17633-A			not required	min. 520	min. 30		
Typical values	M21/C1	AW	min. 320 445	min. 510 560	min. 25 36	45	40

PACKAGING AND AVAILABLE SIZES

Diameter (mm)	1.2
5 kg plastic spool S200	X
15 kg spool S300	X

Cor-A-Rosta® P309L : rev. C-EN27-19/05/16

All information in this data sheet is accurate to the best of our knowledge at the time of printing. Please refer to www.lincolnelectric.eu for any updated information.
 Fumes: Safety Data Sheets (SDS) are available on our website.

Cor-A-Rosta® P309L

EXAMPLES OF MATERIALS TO BE WELDED

Steel grades	EN 10088-1/-2	Mat. Nr	ASTM/ACI A240/A312/A351	UNS
Corrosion resistant cladsteels				
	X2CrNiN18-10	1.4311	(TP)304LN	S30453
	X2CrNi19-11	1.4306	(TP)304L	S30403
			CF-3	J92500
	X4CrNi18-10	1.4301	(TP)304	S30400

Dissimilar metals (mild and low alloy steel to CrNi or CrNiMo stainless steel)

WELDING PARAMETERS, OPTIMUM FILL PASSES

Diameter (mm)	Welding positions		
	PA/1G	PB/2F	PC/G
1.2	100-250A	100-250A	100-200A

REMARKS/APPLICATION ADVICE

For downhand welding, use Cor-A-Rosta 309L

FCAW

Cor-A-Rosta® 309MoL

CLASSIFICATION

AWS A5.22	E309LMoT0-1/-4	A-Nr	8
ISO 17633-A	T 23 12 2 L R C/M 3	F-Nr	6
		9606 FM	5

GENERAL DESCRIPTION

Gas shielded flux cored high CrNiMo alloyed wire electrode for downhand welding
 High Corrosion resistant deposit
 Specially developed for welding stainless steel to mild steel and buffer layers in cladding
 Maximum plate thickness in butt welds ~ 12 mm
 Suitable for repair welding in dissimilar joints and steels difficult to weld

WELDING POSITIONS (ISO/ASME)



CURRENT TYPE / SHIELDING GAS (ISO 14175)

DC +
 M21 : Mixed gas Ar+ (>15-25%) CO₂
 C1 : Active gas 100% CO₂
 Flow rate: 15-25 l/min

CHEMICAL COMPOSITION (W%), TYPICAL, ALL WELD METAL

Shielding gas	C	Mn	Si	Cr	Ni	Mo	FN (acc.WRC 1992)
M21 /C1	0.03	1.3	0.7	23	12.8	2.3	20

MECHANICAL PROPERTIES, TYPICAL, ALL WELD METAL

	Shielding gas	Condition	Yield strength (N/mm ²)	Tensile strength (N/mm ²)	Elongation [%]	Impact ISO-V(J) +20°C
Required: AWS A5.22 ISO 17633-A			not required min. 350	min. 520 min. 550	min. 25 min. 25	
Typical values	M21/C1	AW	550	700	30	50

PACKAGING AND AVAILABLE SIZES

Diameter (mm)	1.2
15 kg spool S300	X

Cor-A-Rosta® 309MoL : rev. C-EN28-19/05/16

Cor-A-Rosta® 309MoL

EXAMPLES OF MATERIALS TO BE WELDED

Steel grades	EN 10088-1/-2	Mat. Nr	ASTM/ACI A240/A312/A351	UNS
Corrosion resistant cladsteels				
	X2CrNiMo17-12-2	1.4404	(TP)316L CF-3M	S31603 J92800
	X2CrNiMo18-14-3	1.4435	(TP)316L	S31603
	X2CrNiMoN17-11-2	1.4406	(TP)316LN	S31653
	X2CrNiMoN17-13-3	1.4429		
	X4CrNiMo17-13-3	1.4436		
	X6CrNiMoTi17-12-2	1.4571	316Ti	S31635
	X10CrNiMoTi17-3	1.4573	316Ti	S31635
	X6CrNiMoNb17-12-2	1.4580	316Cb	S31640

Welding dissimilar metals: mild steel or low alloy steel to stainless CrNi or CrNiMo-steel up to max. thickness of 12 mm.

WELDING PARAMETERS, OPTIMUM FILL PASSES

Diameter (mm)	Welding positions		
	PA/1G	PB/2F	PC/G
1.2	100-250A	100-250A	100-200A

FCAW

REMARKS/APPLICATION ADVICE

For positional welding, use Cor-A-Rosta P309MoL

Cor-A-Rosta® P309MoL

CLASSIFICATION

AWS A5.22	E309LMoT1-1/-4	A-Nr	8
ISO 17633-A	T 23 12 2 L P C/M 2	F-Nr	6
		9606 FM	5

GENERAL DESCRIPTION

Gas shielded flux cored high CrNi alloyed wire electrode for positional welding
 High corrosion resistant deposit
 Specially developed for welding stainless steel to mild steel and buffer layers in cladding
 Maximum plate thickness in butt welds ~ 12 mm
 Suitable for repair welding in dissimilar joints and steels difficult to weld

WELDING POSITIONS (ISO/ASME)



CURRENT TYPE / SHIELDING GAS (ISO 14175)

DC +
 M21 : Mixed gas Ar+ (>15-25%) CO₂
 C1 : Active gas 100% CO₂
 Flow rate: 15-25 l/min

APPROVALS

Shielding gas	LRS
M21	+
C1	+

CHEMICAL COMPOSITION (W%), TYPICAL, ALL WELD METAL

Shielding gas	C	Mn	Si	Cr	Ni	Mo	FN (acc.WRC 1992)
M21 /C1	0.03	0.8	0.6	22.7	12.5	2.3	20

MECHANICAL PROPERTIES, TYPICAL, ALL WELD METAL

	Shielding gas	Condition	Yield strength (N/mm ²)	Tensile strength (N/mm ²)	Elongation (%)	Impact ISO-V(J) +20°C
Required: AWS A5.22 ISO 17633-A			not required min. 350	min. 520 min. 550	min. 25 min. 25	
Typical values	M21/C1	AW	525	675	34	45

PACKAGING AND AVAILABLE SIZES

Diameter (mm)	1.2
15 kg spool S300	X

Cor-A-Rosta® P309MoL : rev. C-EN27-19/05/16

Cor-A-Rosta® P309MoL

EXAMPLES OF MATERIALS TO BE WELDED

Steel grades	EN 10088-1/-2	Mat. Nr	ASTM/ACI A240/A312/A351	UNS
Corrosion resistant cladsteels				
	X2CrNiMo17-12-2	1.4404	(TP)316L CF-3M	S31603 J92800
	X2CrNiMo18-14-3	1.4435	(TP)316L	S31603
	X2CrNiMoN17-11-2	1.4406	(TP)316LN	S31653
	X2CrNiMoN17-13-3	1.4429		
	X4CrNiMo17-13-3	1.4436		
	X6CrNiMoTi17-12-2	1.4571	316Ti	S31635
	X10CrNiMoTi17-3	1.4573	316Ti	S31635
	X6CrNiMoNb17-12-2	1.4580	316Cb	S31640

Welding dissimilar metals: mild steel or low alloy steel to stainless CrNi or CrNiMo-steel up to max. thickness of 12 mm.

WELDING PARAMETERS, OPTIMUM FILL PASSES

Diameter (mm)	Welding positions			
	PA/1G	PB/2F	PC/G	PF/3G up
1.2	100-250A	100-250A	100-200A	100-200A

REMARKS/APPLICATION ADVICE

For downhand welding, use Cor-A-Rosta 309MoL

Cor-A-Rosta® 4462

CLASSIFICATION

AWS A5.22	E2209T0-1/-4	A-Nr	8	Mat-Nr	1.4462
ISO 17633-A	T 22 9 3 N L R C/M 3	F-Nr	6		
		9606 FM	5		

GENERAL DESCRIPTION

Gas shielded flux cored wire electrode for duplex stainless steel welding in downhand position

Excellent weldability

Applicable up to a service temperature of 250°C

High resistance to general corrosion, pitting and stress corrosion conditions

High yield strength > 500 N/mm²

M21 shielding gas is recommended

WELDING POSITIONS (ISO/ASME)



PA/1G



PB/2F



PC/2G

CURRENT TYPE / SHIELDING GAS (ISO 14175)

DC +
 M21 : Mixed gas Ar+ (>15-25%) CO₂
 C1 : Active gas 100% CO₂
 Flow rate: 15-25 l/min

APPROVALS

Shielding gas	DNV
C1	+

CHEMICAL COMPOSITION (W%), TYPICAL, ALL WELD METAL

Shielding gas	C	Mn	Si	Cr	Ni	Mo	N	FN (acc.WRC 1992)
M21	0.03	1.2	0.7	23	9.2	3.1	0.12	40

MECHANICAL PROPERTIES, TYPICAL, ALL WELD METAL

	Shielding gas	Condition	Yield strength [N/mm ²]	Tensile strength [N/mm ²]	Elongation [%]	Impact ISO-V(J)	
						-20°C	-50°C
Required: AWS A5.22			not required	min. 520	min. 25		
ISO 17633-A			min. 450	min. 550	min. 25		
Typical values	M21/C1	AW	630	800	29	50	40

PACKAGING AND AVAILABLE SIZES

Diameter (mm)	1.2
15 kg spool S300	X

Cor-A-Rosta® 4462 : rev. C-EN28-19/05/16

Cor-A-Rosta® 4462

EXAMPLES OF MATERIALS TO BE WELDED

Steel grades	EN 10088-1/-2	Mat. Nr	ASTM/ACI A240/A312/A351	UNS
Duplex stainless steels				
	X2CrNiMoN22-5-3	1.4462		S31803
		1.4417		S31500
	X3CrNiMoN27-5-2	1.4460		S31200
	X2CrNiN23-4	1.4362		S32304
	X2CrMnNi21-5-1	1.4162		S32101

Dissimilar joints such as un- and low alloy steel to duplex stainless steel

WELDING PARAMETERS, OPTIMUM FILL PASSES

Diameter (mm)	Welding positions		
	PA/1G	PB/2F	PC/G
1.2	100-250A	100-250A	100-200A

REMARKS/APPLICATION ADVICE

For positional welding, use Cor-A-Rosta P4462
 Welding with Heat-Input max. 2.5 kJ/mm
 Interpass temperature max. 150°C

FCAW

Cor-A-Rosta® P4462

CLASSIFICATION

AWS A5.22	E2209T1-1/-4	A-Nr	8	Mat-Nr	1.4462
ISO 17633-A	T 22 9 3 N L P M 2	F-Nr	6		
		9606 FM	5		

GENERAL DESCRIPTION

Gas shielded flux cored wire electrode for positional welding of duplex stainless steel

Excellent weldability

Applicable up to a service temperature of 250°C

High resistance to general corrosion, pitting and stress corrosion conditions

High yield strength > 500 N/mm²

WELDING POSITIONS (ISO/ASME)



CURRENT TYPE / SHIELDING GAS (ISO 14175)

DC +
M21 : Mixed gas Ar+ (>15-25%) CO₂
Flow rate: 15-25 l/min

APPROVALS

Shielding gas	LRS
M21	+
C1	+

CHEMICAL COMPOSITION (W%), TYPICAL, ALL WELD METAL

Shielding gas	C	Mn	Si	Cr	Ni	Mo	N	FN (acc.WRC 1992)
M21	0.03	1.2	0.7	23	9.2	3.1	0.12	40

MECHANICAL PROPERTIES, TYPICAL, ALL WELD METAL

	Shielding gas	Condition	Yield strength [N/mm ²]	Tensile strength [N/mm ²]	Elongation [%]	Impact ISO-V[J]	
						-20°C	-50°C
Required: AWS A5.22 ISO 17633-A			not required	min. 690	min. 25		
Typical values	M21	AW	min. 450 630	min. 550 800	min. 25 29	65	55

PACKAGING AND AVAILABLE SIZES

Diameter (mm)	1.2
15 kg spool S300	X

Cor-A-Rosta® P4462 : rev. C-EN28-19/05/16

Cor-A-Rosta® P4462

EXAMPLES OF MATERIALS TO BE WELDED

Steel grades	EN 10088-1/-2	Mat. Nr	ASTM/ACI A240/A312/A351	UNS
Duplex stainless steels				
	X2CrNiMoN22-5-3	1.4462		S31803
		1.4417		S31500
	X3CrNiMoN27-5-2	1.4460		S31200
	X2CrNiN23-4	1.4362		S32304
	X2CrMnNi21-5-1	1.4162		S32101

Dissimilar joints such as un- and low alloy steel to duplex stainless steel

WELDING PARAMETERS, OPTIMUM FILL PASSES

Diameter (mm)	Welding positions			
	PA/1G	PB/2F	PC/G	PF/3G up
1.2	100-250A	100-250A	100-200A	130-180A

REMARKS/APPLICATION ADVICE

For downhand welding, use Cor-A-Rosta 4462
 Welding with Heat-Input max. 2.5 kJ/mm
 Interpass temperature max. 150°C

FCAW

Lincore[®] 33

CLASSIFICATION

EN 14700 T Fe1

GENERAL DESCRIPTION

Delivers tough machinable deposits for build-up or final overlay intended for metal-to-metal wear
 Use for build-up of steel mill parts such as rougher couplings
 Build-up deposit on carbon steel and low alloy steel base metals
 It is ideal for rebuilding worn parts to near final dimensions before applying final hardfacing layers which are more wear resistant
 Unlimited layer

WELDING POSITIONS (ISO/ASME)



PA/1G

CURRENT TYPE

DC+

CHEMICAL COMPOSITION (W%), TYPICAL, ALL WELD METAL

C	Mn	Si	Cr	Al
0.15	2.0	0.7	2.0	1.6

STRUCTURE

In the as welded condition the microstructure consists mainly of a mixture of ferrite and bainite

MECHANICAL PROPERTIES, TYPICAL, ALL WELD METAL

Typical hardness values

Layer 1	21-30 HRc (230-290HB)
Layer 2	26-32 HRc (260-300HB)
Layer 3	28-34 HRc (250-330HB)
Welded on Mild Steel Plate (12mm)	

PACKAGING AND AVAILABLE SIZES

Diameter (mm)	1.1	1.6	2.0	2.8
6.35 kg coil 14C			X	
11.34kg coil 22RR	X	X	X	
22.68 kg coil 50C			X	X

Lincore[®] 33: rev. C-EN23-01/02/16

All information in this data sheet is accurate to the best of our knowledge at the time of printing. Please refer to www.lincolinelectric.eu for any updated information.
 Fumes: Safety Data Sheets (SDS) are available on our website.

Lincore[®] 33

APPLICATION

Lincore 33 produces a crack-free wear resistant deposit with a hardness range of 25-35 HRC depending on material dilution and number of layers. Designed primarily as a final overlay on steel parts which need to be machined or as a build-up layer of other hardfacing materials. It is particularly suitable of conditions of moderate abrasion and friction, coupled with resistance to impact such as applications involving rolling, sliding and metal to metal wear.

Typical applications include:

Buildup:

Shovel and bucket lips
 Pump impellers and housings
 Dredge and shovel bucket teeth
 Mill and crushing hammers

Hardfacing:

Crane and mine car wheels
 Tractor rolls, idlers, links and sprockets
 Cable drums
 Roller guides
 Shafts

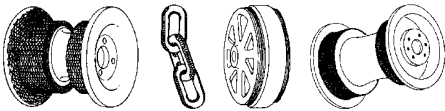

ADDITIONAL INFORMATION

All work-hardened base material should be removed prior to applying Lincore 33 to prevent embrittlement and cracking.

Preheat and postweld heat treatment is not generally necessary on C/Mn steels, however, preheat up to 260°C may be necessary on high carbon steels or large complex or restrained components.

The deposited weld metal can be machined to exact dimensions using high speed or carbide cutting tools.

There is no limit to the deposit build-up with this electrode.

CALCULATION DATA

Diameter (mm)	Wire Feed Speed (cm/min)	Current [A]	Arc Voltage [V]	Deposition rate (kg/h)	Efficiency [%]
1.1	5.1-12.7	80-150	25-31	1.5-3.9	80-85
1.6	3.8-8.9	125-225	26-32	2.1-5.0	79-84
2.0	3.2-6.4	200-325	23-29	3.1-6.1	87-86
2.8	3.4-6.0	360-470	26-30	5.7-9.6	

COMPLEMENTARY PRODUCTS

Wearshield[®] BU30

Lincore[®] 40-0

CLASSIFICATION

EN 14700 T Fe1

GENERAL DESCRIPTION

Higher hardness for metal-to-metal wear and mild abrasion
 Used on transfer rollers and guides, crane wheels and shafts
 Can be used on low carbon and low alloy steels
 Unlimited layers with proper preheat and interpass temperatures and procedures

WELDING POSITIONS (ISO/ASME)



PA/1G

CURRENT TYPE

DC+

CHEMICAL COMPOSITION (W%), TYPICAL, ALL WELD METAL

C	Mn	Si	Cr	Al	Mo
0.2	1.5	0.7	3.5	1.8	0.4

STRUCTURE

Martensitic

MECHANICAL PROPERTIES, TYPICAL, ALL WELD METAL

Typical hardness values

Layer 1	ca. 36 HRC (340HB)
Layer 2	ca. 41 HRC (380HB)

PACKAGING AND AVAILABLE SIZES

Diameter (mm)	2.0
11.34kg coil 22RR	X

Lincore[®] 40-0: rev. C-EN23-01/02/16

All information in this data sheet is accurate to the best of our knowledge at the time of printing. Please refer to www.lincolnelectric.eu for any updated information.
 Fumes: Safety Data Sheets (SDS) are available on our website.

Lincore[®] 40-0

APPLICATION

This electrode provides an overlay hardfacing deposit on carbon and low alloy steels that resists rolling, sliding and metal-to-metal wear under heavy impact conditions. The deposit has a hardness of about 40 HRC which fills in the rather large hardness gap between the ferritic bainite buildup deposit of Lincore 33 and the martensitic deposit from Lincore 55 designed for metal-to-metal wear. Although the electrode is designed to provide a hardfacing deposit by itself, it could be used as a build-up electrode to provide a base on which harder deposits could be overlaid.

Typical applications include:

Tractor rolls
Mine car wheels
Guide rollers
Bucket links and bases
Actuating cams

Mine car wheels

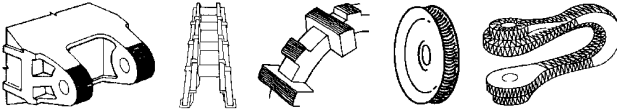

ADDITIONAL INFORMATION

The area to be hardfaced should be clean and free of rust, scale, oil, grease or dirt of any kind. Any previous hardfacing deposit that has been embrittled by severe work hardening should also be removed. Irregularities such as cracks, low spots etc. should be properly repaired before hardfacing. Cold parts should be preheated to at least 40°C. Larger parts, and those made of higher alloy or higher carbon steel, should be preheated to the 100-150°C range.

Lincore 40-0 deposits normally have good resistance to cross-checking. Special precautions, however, should be taken with any buildup or hardfacing product on applications that are inherently crack sensitive. These applications include the facing of high carbon or alloy steels, previously faced parts and highly stressed parts. The facing of heavy cylinders, massive parts and parts having complex shapes are all examples of applications producing high internal stresses that may result in delayed cracking.

These applications may require one or more of the following:

1. Higher preheat temperature (150-260°C).
2. Higher interpass temperatures.
3. Controlled slow cooling between passes and/or layers

Interpass temperatures in the range of 150-200°C will not significantly affect the hardness of weld deposits produced by Lincore 40-0.

The weld deposited, can be machined with carbide tools or can be finished by grinding.

CALCULATION DATA

Diameter (mm)	Wire Feed Speed (cm/min)	Current (A)	Arc Voltage (V)	Deposition rate (kg/h)	Efficiency (%)
2.0	3.2-6.4	200-325	23-29	3.1-6.1	87-86

COMPLEMENTARY PRODUCTS

Wearshield[®] MM40

Lincore[®] 50

CLASSIFICATION

EN 14700 T Fe8

GENERAL DESCRIPTION

Delivers an abrasion resistant deposit, even under conditions of moderate impact
 Larger wire diameter sizes may be used for the submerged arc process
 Can be used on low carbon, medium carbon, low alloy, manganese and stainless steels
 Limited to 4 layers

WELDING POSITIONS (ISO/ASME)



PA/1G

CURRENT TYPE

DC+

CHEMICAL COMPOSITION (W%), TYPICAL, ALL WELD METAL

C	Mn	Si	Cr	Al	Mo
2.2	1.2	1.0	11.0	0.6	0.5

STRUCTURE

In the as welded condition the microstructure consists mainly of primary austenite with an austenite-carbide eutectic

MECHANICAL PROPERTIES, TYPICAL, ALL WELD METAL

Typical hardness values

Layer 1	34-41 HRc (320-380HB)
Layer 2	44-53 HRc (415-530HB)
Layer 3	48-56 HRc (460-584HB)
Welded on Mild Steel Plate (12mm)	

PACKAGING AND AVAILABLE SIZES

Diameter (mm)	1.1	1.2	1.6	2.0	2.8
11.34kg coil 22RR	X		X	X	
22.68 kg coil 50C		X	X	X	X

Lincore[®] 50: rev. C-EN23-01/02/16

All information in this data sheet is accurate to the best of our knowledge at the time of printing. Please refer to www.lincolnelectric.eu for any updated information.
 Fumes: Safety Data Sheets (SDS) are available on our website.

Lincore[®] 50

APPLICATION

Lincore 50 produces an abrasion and impact resistant deposit with a hardness range of 34-56HRC depending on base metal chemistry, material dilution and number of layers. The combination of abrasion and impact resistance coupled with hot forging properties makes Lincore 50 particularly suitable for applications involving transportation of abrasive media under heavy variable loading.

Typical applications include:

- Crusher rolls
- Dredge cutter teeth
- Ore chute baffles
- Muller plows and tires
- Coal mining cutting teeth

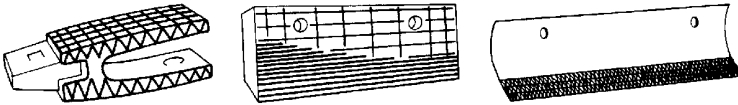

ADDITIONAL INFORMATION

All work-hardened base material and previously deposited hardfacing material should be removed prior to applying a new deposit, since such areas are prone to embrittlement and possible cracking. Areas that contain irregularities such as cracks and deep gouges can be repaired locally using Wearshield BU30 or Wearshield 15CrMn prior to hardfacing with Lincore 50.

Preheat is not necessary when surfacing austenitic substrates such as stainless steels and manganese steels, although the interpass temperature should be limited to about 260°C for manganese steels.

For low alloy and carbon carbon steels a preheat of 200°C is usually sufficient, but is dependent on material thickness and chemistry.

The weld metal is not machinable by conventional methods although the deposit can be shaped by grinding. Lincore 50 cannot be cut by the oxy-fuel processes. Plasma arc and air-carbon arc processes can be used to both cut an gouge the weld deposit. Preheat temperatures similar to those for welding may be necessary to prevent cracking along the cut edge.

Lincore 50 may also be used in corrosive, cavitation and erosion situations such as the chemical, paper mill, food processing industry, glass manufacturing, power generation and tool manufacturing.

CALCULATION DATA

Diameter (mm)	Wire Feed Speed (cm/min)	Current (A)	Arc Voltage (V)	Deposition rate (kg/h)
1.1	5.1-15.2	120-250	20-28	1.9-5.8
1.6	3.8-8.9	175-365	23-33	2.7-7.9
2.0	3.2-6.4	210-380	27-23	3.4-6.8
2.8	2.0-3.3	315-450	26-29	3.9-6.4

COMPLEMENTARY PRODUCTS

There is no direct equivalent to Lincore 50 although Wearshield[®] ABR and Wearshield[®] 44 are the nearest.

Lincore[®] 55

CLASSIFICATION

EN 14700 T Fe2

GENERAL DESCRIPTION

Delivers a deposit which resists metal-to-metal rolling or sliding wear as well as mild abrasion
To be used on carbon steel, low alloy steel and manganese steel
Unlimited layers with proper preheat and interpass temperatures and procedures

WELDING POSITIONS (ISO/ASME)



PA/1G

CURRENT TYPE

DC+

CHEMICAL COMPOSITION (W%), TYPICAL, ALL WELD METAL

C	Mn	Si	Cr	Al	Mo
0.45	1.4	0.55	5.3	1.4	0.8

STRUCTURE

In the as welded condition the microstructure consists mainly of martensite with some retained austenite

MECHANICAL PROPERTIES, TYPICAL, ALL WELD METAL

Typical hardness values

Layer 1 50 - 59 HRC
Layer 2 50 - 59 HRC
Welded on Mild Steel Plate (12mm)

PACKAGING AND AVAILABLE SIZES

Diameter (mm)	1.1	1.6	2.0	2.8
6.35 kg coil 14C			X	
11.34kg coil 22RR	X	X	X	
22.68 kg coil 50C			X	X

Lincore[®] 55: rev. C-EN22-01/02/16

All information in this data sheet is accurate to the best of our knowledge at the time of printing. Please refer to www.lincolinelectric.eu for any updated information.
Fumes: Safety Data Sheets (SDS) are available on our website.

Lincore[®] 55

APPLICATION

Lincore 55 produces a martensitic and some retained austenite deposit with a hardness range of 50-59HRC. This microstructure makes Lincore 55 particularly suitable for applications involving sliding, rolling and metal to metal wear, coupled with resistance to mild abrasion.

Typical applications include:

- Crusher rolls
- Dredge cutter teeth
- Ore chute baffles
- Muller plows and tires
- Coal mining cutting teeth

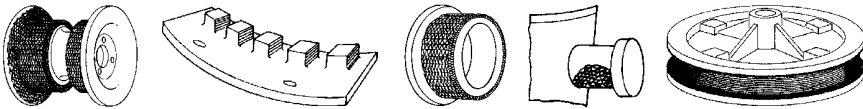

ADDITIONAL INFORMATION

All work-hardened base material and previously deposited material should be removed prior to applying a new deposit, since such areas are prone to embrittlement and possible cracking.

A preheat of up to 250°C is necessary to prevent cracking in situations of high restraint and/or heavy thicknesses. Interpass temperatures between 150 - 300°C do not adversely effect deposit hardness.

The deposit thickness is usually limited to 2 layers on high carbon or alloy steels and/or situations of high restraint and heavy sections due to the risk of cracking. Higher preheat and interpass temperatures coupled with slow cooling will minimise the risk of cracking.

The deposited weld metal is not machinable by conventional methods although the deposit can be shaped by grinding.

The deposit can be softened by annealing at 875°C for one hour and slow cooling (air cool 22- 43HRC, furnace cool 15-17HRC). The hardness can be restored by heating at 875°C followed by water quenching (50-59HRC). The component should then be tempered at 150-200°C for one hour (54-59HRC) to retain some toughness.

CALCULATION DATA

Diameter (mm)	Wire Feed Speed (cm/min)	Current (A)	Arc Voltage (V)	Deposition rate (kg/h)	Efficiency (%)
1.1	5.1-12.7	85-165	25-31	1.6-4.3	80-85
1.6	3.8-8.9	125-245	26-32	2.2-5.5	79-84
2.0	3.2-6.4	190-330	24-30	3.2-6.2	87-86
2.8	2.3-4.4	280-420	25-30	3.8-7.3	

COMPLEMENTARY PRODUCTS

Wearshield[®] MM and Wearshield[®] M(e)

Lincore® 60-0

CLASSIFICATION

EN 14700 T Fe15

GENERAL DESCRIPTION

Deposits feature higher alloy levels than to resist both abrasion and moderate impact
 Can be used at temperatures up to 704°C
 To be used on carbon, low alloy, manganese and stainless steels and cast iron
 Deposit is limited to two layers.

WELDING POSITIONS (ISO/ASME)



PA/1G

CURRENT TYPE

DC+

CHEMICAL COMPOSITION (W%), TYPICAL, ALL WELD METAL

C	Mn	Si	Cr	Al
4.2	1.6	1.3	25.4	0.6

STRUCTURE

In the as welded condition the microstructure consists of primary carbides in an austenite - carbide eutectic matrix

MECHANICAL PROPERTIES, TYPICAL, ALL WELD METAL

Typical hardness values

Layer 1 55 - 60 HRc
 Layer 2 58 - 60 HRc
 Welded on Mild Steel Plate (12mm)

PACKAGING AND AVAILABLE SIZES

Diameter (mm)	1.1	1.6	2.0
11.34kg coil 22RR	X	X	X

Lincore® 60-0; rev. C-EN23-01/02/16

Lincore® 60-0

APPLICATION

Lincore 60-0 produces a primary carbide weld deposit with a hardness range of 55-60HRC. The primary carbide microstructure makes Lincore 60-0 ideally suitable for applications of severe abrasion.

Typical applications include:

- Bucket lips
- Crusher hammers
- Ore chutes
- Dozer blades
- Ripper teeth

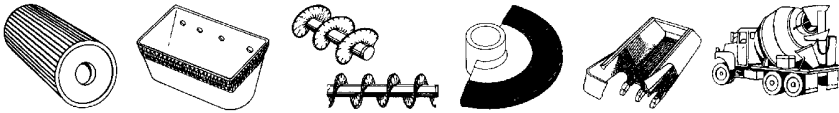

ADDITIONAL INFORMATION

When welding with Lincore 60-0 stringer beads should be employed. Weaving is not advised since wide weaves generally increase the check crack spacing which can result in deposit spalling. Preheat is not necessary when surfacing austenitic substrates such as stainless steels and manganese steels, although the interpass temperature should be limited to about 260°C for manganese steels. For low alloy and high carbon steels a preheat of 200°C is necessary to prevent heat affected zone cracking.

Preheat is not necessary when surfacing austenitic substrates such as stainless steels and manganese steels, although the interpass temperature should be limited to about 260°C for manganese steels. For low alloy and high carbon steels a preheat of 200°C is necessary to prevent heat affected zone cracking.

The weld metal is not machinable or forgeable and it readily check cracks. The deposit thickness is usually limited to 2 layers, as excessive build-up will result in chipping and fragmentation.

For applications requiring build-ups in excess of 2 layers, buttering layers of Lincore 33, Wearshield BU30 or RepTec 126

Alternatively, a preheat of 650°C can be used to eliminate the formation of check cracks

CALCULATION DATA

Diameter (mm)	Wire Feed Speed (cm/min)	Current (A)	Arc Voltage (V)	Deposition rate (kg/h)
1.1	5.1-12.7	125-210	21-27	1.9-4.7
1.6	5.1-11.4	240-350	28-33	3.4-7.5
2.0	3.2-4	250-400	25-32	3.4-6.9

COMPLEMENTARY PRODUCTS

Complementary products include Wearshield® 60.

Lincore® T&D

CLASSIFICATION

EN 14700 T Fe8

GENERAL DESCRIPTION

Delivers a deposit similar to H12 tool steel
 For build-up of tool steel dies and edges, or applying wear resistance surface on carbon or low alloy steels
 To be used on carbon steel, low alloy steel or tool steel

WELDING POSITIONS (ISO/ASME)



PA/1G

CURRENT TYPE

DC+

CHEMICAL COMPOSITION (W%), TYPICAL, ALL WELD METAL

C	Mn	Si	Cr	Al	Mo	W
0.65	1.5	0.8	7.0	1.8	1.4	1.6

STRUCTURE

In the as welded condition the microstructure consists mainly of martensite with some carbides. After tempering the microstructure consists of tempered martensite with secondary carbides

MECHANICAL PROPERTIES, TYPICAL, ALL WELD METAL

Typical hardness values

As welded 48 - 55 HRc
 Tempered at 540°C 55 - 65 HRc
 Welded on Mild Steel Plate (12mm)

PACKAGING AND AVAILABLE SIZES

Diameter (mm)	1.6
11.34kg coil 22RR	X

Lincore® T&D: rev. C-EN24-01/02/16

Lincore® T&D

APPLICATION

Lincore T&D produces a crack-free wear resistant tool steel deposit with a hardness range of 48- 55HRc. The hardness can be further increased to between 55-65HRc after tempering. It is particularly suitable for applications involving severe metal to metal wear coupled with elevated temperatures (up to 540°C). Ideally suited to the build up of worn steel dies, cutting tools or the APL of wear resistant surfaces to carbon and low alloy steels.

Typical applications include:

Punch dies
Shear blades

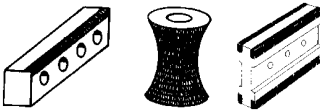

ADDITIONAL INFORMATION

A preheat and interpass temperature of 325°C, or higher (up to 540°C), are necessary to avoid cracking. It is important to ensure that an adequate "soak" is achieved prior to the welding operation. After welding, the component should be covered and slow cooled down to room temperature. Once cooled, the weldment should be post weld heat treated to temper the martensite and toughen the deposit. Tempering at 540°C normally produces the optimum combination of hardness and toughness.

The deposited weld metal is not machinable by conventional methods although the deposit can be shaped by grinding.

Annealing at 850°C for several hours and slow cooling will reduce the hardness to approximately 30HRc. This deposit can be readily machined. Rehardening is achieved by heating to about 1200°C for several hours to dissolve all carbides and homogenise the steel, followed by air cooling and tempering.

Lincore T&D cannot be cut by the oxy-fuel processes. Plasma arc and air-carbon arc processes can be used to both cut and gouge the weld deposit. Preheat temperatures similar to those for welding may be necessary to prevent cracking along the cut edge.

CALCULATION DATA

Diameter (mm)	Wire Feed Speed (cm/min)	Current (A)	Arc Voltage (V)	Deposition rate (kg/h)
1.6	3.8-8.9	170-300	22-26	2.4-5.4

COMPLEMENTARY PRODUCTS

Complementary products include Wearshield® T&D

Lincore[®] 15CrMn

CLASSIFICATION

EN 14700 T Fe9

GENERAL DESCRIPTION

Provides an austenitic manganese deposit which exhibits very good crack resistance
 Work-hardens for overlay or joining austenitic manganese steel to itself or to carbon steel
 Can be used as a build-up layer before capping with abrasion resistant alloys
 Can be used in open arc mode for joining austenitic manganese steel to carbon steel, low alloy steel, austenitic manganese steel, or stainless steel
 Unlimited layers with proper preheat and interpass temperatures and procedures

WELDING POSITIONS (ISO/ASME)



PA/1G

CURRENT TYPE

DC+

CHEMICAL COMPOSITION (W%), TYPICAL, ALL WELD METAL

C	Mn	Si	Cr
0.4	15.0	0.25	16.0

STRUCTURE

In the as welded condition, the microstructure consists of a soft chromium manganese alloy austenite which rapidly work hardens under impact loading

MECHANICAL PROPERTIES, TYPICAL, ALL WELD METAL

Typical hardness values

As deposited	18 - 22 HRC [210-235 HB]
Work Hardened	40 - 50 HRC [375-490HB]

PACKAGING AND AVAILABLE SIZES

Diameter (mm)	2.0	2.8
11.34kg coil 22RR		X
22.68 kg coil 50C	X	

Lincore[®] 15CrMn rev. C-EN23-01/02/16

All information in this data sheet is accurate to the best of our knowledge at the time of printing. Please refer to www.lincolnelectric.eu for any updated information.
 Fumes: Safety Data Sheets (SDS) are available on our website.

Lincore[®] 15CrMn

APPLICATION

Lincore 15CrMn produces a premium austenitic chromium-manganese deposit. The term premium is used because the weld metal has sufficient alloy content to produce a single pass austenitic deposit on ordinary carbon steel. The deposit rapidly work hardens under impact making it particularly suitable for applications of high impact and gouging coupled with moderate abrasion. In addition to surfacing, the high crack resistance of this alloy design makes Lincore 15CrMn an ideal electrode for joining manganese steel to itself or carbon steels with minimal the risk of centerline cracking. Joining by the SAW process, however, is not recommended.

Typical applications include:
Spreader Cones
Crusher Hammers
Austenitic manganese parts

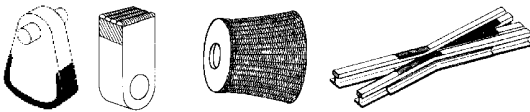

ADDITIONAL INFORMATION

All work-hardened base material and previously deposited material should be removed prior to applying a new deposit, since such areas are prone to embrittlement and possible cracking. No preheat is required on austenitic manganese steels although a preheat of between 150-200°C may be necessary on carbon and low steels to prevent heat affected zone cracking.

Narrow stringer beads are preferred to avoid excessive heat build up in the base material. High heat input welds and interpass temperatures above 260°C causes manganese carbide precipitation resulting in embrittlement.

There is no definite limitation to the number of passes that may be deposited, however, it is good practise to peen each pass immediately after welding to minimise internal stresses and possible distortion and cracking.

Lincore 15CrMn deposits work harden rapidly making them difficult to machine. For best results carbide or ceramic cutting tools and rigid tooling should be used. Grinding can also be successfully employed.

For applications involving severe impact and abrasion, a build-up of Lincore 15CrMn coupled with a single pass of Wearshield 60 or Lincore 60-O should be employed.

The Lincore 15CrMn deposit can not be cut using the oxy-fuel process due to the high chromium content, however, plasma arc and air carbon arc processes are appropriate.

CALCULATION DATA

Diameter (mm)	Wire Feed Speed (cm/min)	Current (A)	Arc Voltage (V)	Deposition rate (kg/h)
2.0	3.2-8.9	210-380	26-32	3.3-9.7
2.8	1.9-4.4	250-380	26-30	2.5-7.5

COMPLEMENTARY PRODUCTS

Complementary products include Wearshield[®] 15CrMn

Lincore[®] 420

GENERAL DESCRIPTION

Metal-cored wire that is most widely used for caster roll rebuilding

WELDING POSITIONS (ISO/ASME)



PA/1G

CURRENT TYPE

DC+

CHEMICAL COMPOSITION (W%), TYPICAL, ALL WELD METAL

C	Mn	Si	Cr
0.2	1.2	0.5	12.0

STRUCTURE

In the as welded condition, the microstructure consists of a soft chromium manganese alloy austenite which rapidly work hardens under impact loading

MECHANICAL PROPERTIES, TYPICAL, ALL WELD METAL

Typical hardness values

Layer 1	52 HRc
Layer 2	51 HRc
Layer 3	53 HRc
Welded on Mild Steel Plate (12mm)	

PACKAGING AND AVAILABLE SIZES

Diameter (mm)	4.0
272.2 kg speed Feed [®] Drum	X

Lincore[®] 420 rev. C-EN24-01/02/16

All information in this data sheet is accurate to the best of our knowledge at the time of printing. Please refer to www.lincolnelectric.eu for any updated information.
Fumes: Safety Data Sheets (SDS) are available on our website.

Lincore[®] 420

APPLICATION

Lincore 420 is martensitic stainless hardfacing electrode designed to provide overlay deposits that resists metal wear under corrosion.

Typical applications include:
Caster rolls

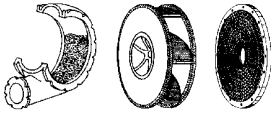

ADDITIONAL INFORMATION

All work-hardened base material and previously deposited material should be removed prior to applying a new deposit, since such areas are prone to embrittlement and possible cracking.

Areas that contain irregularities such as cracks and deep gouges can be repaired locally using Wearshield[®] BU30 or Wearshield[®] 15CrMn prior to hardfacing with Lincore 420.

Preheat would be needed if the welding is done over either highly restrained material or martensitic stainless base metal.

A preheat and interpass temperature in the range of 200-300°C can be used depending on the nature of the material to be welded.

Under conditions of low dilution, the microstructure is similar to that of AISI 420 martensitic stainless steel. This structure provides good abrasion resistance under conditions of severe corrosion and high impact. At higher dilutions, when overlaid on mild steel or low alloy steel, the weld metal microstructure will retain its martensitic stainless structure. But the reduced chromium level might adversely affect the corrosion resistance of the deposit.

The Lincore 15CrMn deposit can not be cut using the oxy-fuel process due to the high chromium content, however, plasma arc and air carbon arc processes are appropriate.

CALCULATION DATA

Diameter (mm)	Wire Feed Speed (cm/min)	Current (A)	Arc Voltage (V)	Deposition rate (kg/h)
4.0	1.4-2.9	475-800	27-32	5.9-12.4

Lincore[®] M

CLASSIFICATION

EN 14700 T Fe9

GENERAL DESCRIPTION

Deposit resists severe impact as well as moderate abrasion
 Produces an austenitic manganese deposit that work-hardens
 Recommended for build-up and repair of Hadfield-type austenitic manganese materials as well as carbon and low alloy steels
 Unlimited layers with proper preheat and interpass temperatures and procedures

WELDING POSITIONS (ISO/ASME)



PA/1G

CURRENT TYPE

DC+

CHEMICAL COMPOSITION (W%), TYPICAL, ALL WELD METAL

C	Mn	Si	Cr	Ni
0.6	13.0	0.4	4.9	0.5

STRUCTURE

Martensitic + ferritic

MECHANICAL PROPERTIES, TYPICAL, ALL WELD METAL

Typical hardness values

As deposited	18-28 Rc
Work Hardened	30-48 Rc

PACKAGING AND AVAILABLE SIZES

Diameter (mm)	1.1	1.6	2.0	2.8
11.34kg coil 22RR	X	X	X	
22.68 kg coil 50C			X	X
272.2 kg speed Feed [®] Drum				X

Lincore[®] M rev. C-EN24-01/02/16

All information in this data sheet is accurate to the best of our knowledge at the time of printing. Please refer to www.lincolinelectric.eu for any updated information.
 Fumes: Safety Data Sheets (SDS) are available on our website.

Lincore[®] M

APPLICATION

Lincore M is designed for rebuilding and hardfacing of manganese steel, carbon steel and low alloy steel parts

Typical applications include:

- Hammers
- Dredge parts
- Crushers
- Breaker bars
- Buckets

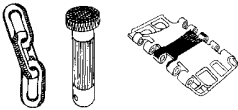

ADDITIONAL INFORMATION

All work-hardened base material and previously deposited material should be removed prior to applying a new deposit, since such areas are prone to embrittlement and possible cracking.

No preheat is required on austenitic manganese steels although a preheat of between 150-200°C may be necessary on carbon and low steels to prevent heat affected zone cracking.

Narrow stringer beads are preferred to avoid excessive heat build up in the base material. High heat input welds and interpass temperatures above 260°C causes manganese carbide precipitation resulting in embrittlement.

There is no definite limitation to the number of passes that may be deposited, however, it is good practise to peen each pass immediately after welding to minimise internal stresses and possible distortion and cracking.

Lincore M deposits work harden rapidly making them difficult to machine. For best results carbide or ceramic cutting tools and rigid tooling should be used. Grinding can also be successfully employed.

CALCULATION DATA

Diameter (mm)	Wire Feed Speed (cm/min)	Current (A)	Arc Voltage (V)	Deposition rate (kg/h)
1.1	5.1-12.7	80-185	22-26	1.5-4.4
1.6	3.8-8.9	130-250	23-27	2.2-5.6
2.0	3.2-6.4	240-360	24-29	2.9-6.2
2.8	1.9-3.8	240-395	25-28	3.5-7.5

COMPLEMENTARY PRODUCTS

Complementary products include Wearshield[®] Mangjet(e)

SUBMERGED ARC CONSUMABLES

Mild steel, Solid Wires

L-60.....	527
L-61.....	528
LNS 135.....	529
L-50M.....	530

Low Alloy Solid Wires

L-70.....	531
LNS 140A.....	532
LNS 133TB.....	533
LNS 140TB.....	534
LNS 150.....	535
LNS 151.....	536
LNS 160.....	537
LNS 162.....	538
LNS 163.....	539
LNS 164.....	540
LNS 165.....	541
LNS 168.....	542
LNS 175.....	543

Mild Steel Flux-Cored Wires

LNS T55.....	544
--------------	-----

Stainless Steel Solid Wires

LNS 304L.....	545
LNS 304H.....	546
LNS 307.....	547
LNS 309L.....	548
LNS 316L.....	549
LNS 318.....	550
LNS 347.....	551
LNS 4455.....	552
LNS 4462.....	553
LNS 4500.....	554
LNS Zeron® 100X.....	555

Nickel base Solid Wires

LNS NiCro 60/20.....	556
LNS NiCro 70/19.....	557
LNS NiCro Mo 60/16.....	558

Fluxes

761.....	560
780.....	562
781.....	564
782.....	566
708GB.....	568
802.....	569
839.....	570
842-H.....	572
8500.....	574
860.....	576
888.....	578
960.....	580
980.....	582
995N.....	584
998N.....	586
P223.....	588
P230.....	592
P240.....	594
P2000.....	596
P2007.....	598
P2000S.....	600



Sahara ReadyBag™

**SOLUTION FOR ANY HAZARDOUS
FLUX STORAGE CONDITIONS**

**MOISTURE RESISTANT PACKAGING
FOR SUBMERGED ARC FLUXES**



L-60

CLASSIFICATION

AWS A5.17	EL12	A-Nr	1
ISO 14171-A	S1	F-Nr	6
		9606 FM	1

GENERAL DESCRIPTION

A low carbon, low manganese, low silicon general purpose wire
Provides low hardness and is best suited for use with the 700 series of active fluxes

APPROVALS

	GL	TÜV	BV	ABS	LR	DNV	RINA
782		X					
860	X	X					
780		X	X	X	X	X	X
781		X					
761		X					

CHEMICAL COMPOSITION (W%), TYPICAL, WIRE

C	Mn	Si
0.09	0.5	0.06

PACKAGING AND AVAILABLE SIZES

Diameter (mm)	1.6	2.0	2.4	3.2	4.0
15 kg stein basket	X				
25 kg stein basket B415+VCI	X	X	X	X	X
100 kg stein basket B785				X	X
300 kg wooden reel					X
350 kg Speed Feed® Drum		X	X	X	X
400 kg Speed Feed® Drum		X	X	X	X
600 kg Accutrak® Drum		X	X		
1000 kg Accutrak® Drum		X	X	X	X

L-60: rev. C-EN03-01/02/16

All information in this data sheet is accurate to the best of our knowledge at the time of printing. Please refer to www.lincolnelectric.eu for any updated information.
Fumes: Safety Data Sheets (SDS) are available on our website.

L-61

CLASSIFICATION

AWS A5.17	EM12K	A-Nr	1
ISO 14171-A	S2Si	F-Nr	6
		9606 FM	1

GENERAL DESCRIPTION

Industry standard for submerged arc welding applications
 A low carbon, medium manganese, low silicon general purpose submerged arc wire
 A good choice for a wide range of applications with single or multiple pass subarc welding

APPROVALS

	ABS	TÜV	BV	DNV	GL	LRS	RINA	RMRS	CRS	PRS
761	X	X	X	X	X	X	X	X	X	X
780		X	X	X	X	X	X	X	X	X
8500					X					
888		X								
860	X	X	X	X	X	X	X	X	X	
P230	X	X				X	X			
781		X								

CHEMICAL COMPOSITION (W%), TYPICAL, WIRE

C	Mn	Si
0.1	1.0	0.25

PACKAGING AND AVAILABLE SIZES

Diameter (mm)	1.6	2.0	2.4	3.2	4.0	4.8
25 kg stein basket B415+VCI	X	X	X	X	X	X
100 kg stein basket B785		X	X	X	X	X
200 kg Speed Feed® Drum		X				
300 kg wooden reel		X	X	X	X	
350 kg Speed Feed® Drum	X	X				
400 kg Speed Feed® Drum			X	X	X	
600 kg Speed Feed® Drum			X		X	
600 kg Accutrak® Drum	X	X	X			
1000 kg Accutrak® Drum		X	X	X	X	
1000 kg coil liftable		X			X	

LNS 135

CLASSIFICATION

AWS A5.17	EM12	A-Nr	1
ISO 14171-A	S2	F-Nr	6
		9606 FM	1

GENERAL DESCRIPTION

A low carbon, medium manganese, low silicon general purpose wire
Provides low hardness and is best suited for use with the 700 and 800 series of active fluxes

APPROVALS

	GL	TÜV
782		X
860	X	X
761		X
780		X
P230		X

CHEMICAL COMPOSITION (W%), TYPICAL, WIRE

C	Mn	Si
0.1	1.0	0.10

PACKAGING AND AVAILABLE SIZES

Diameter (mm)	2.4	3.2	4.0	4.8
25 kg stein basket B415+VCI	X	X	X	
300 kg wooden reel	X	X		
400 kg Speed Feed® Drum			X	
1000 kg Accutrak® Drum			X	
1000 kg coil liftable		X	X	X

LNS 135 rev. C-EN03-01/02/16

All information in this data sheet is accurate to the best of our knowledge at the time of printing. Please refer to www.lincolnelectric.eu for any updated information.
Fumes: Safety Data Sheets (SDS) are available on our website.

L-50M (LNS 133-U)

CLASSIFICATION

AWS A5.17	EH12K	A-Nr	1
ISO 14171-A	S3Si	F-Nr	6
		9606 FM	1

GENERAL DESCRIPTION

A low carbon, high manganese, low silicon general purpose submerged arc wire
 Suitable for both single and multiarc subarc applications
 Provides extra mechanical properties compared to an EM12K wire grade

APPROVALS

	ABS	TÜV	BV	DNV	LRS	RINA	CRS
782	X		X	X		X	
8500	X		X	X	X		
P230		X	X	X	X		
P240	X	X	X	X	X		X
780		X					
781	X		X	X	X	X	

CHEMICAL COMPOSITION (W%), TYPICAL, WIRE

C	Mn	Si
0.1	1.6	0.25

PACKAGING AND AVAILABLE SIZES

Diameter (mm)	1.6	2.0	2.4	3.2	4.0
15 kg stein basket B415	X	X			
25 kg stein basket B415+VCI	X	X	X	X	X
100 kg stein basket B785					X
300 kg wooden reel	X		X		X
350 kg Speed Feed® Drum		X			
400 kg Speed Feed® Drum		X	X	X	X
600 kg Accutrak® Drum			X		
1000 kg Accutrak® Drum	X				
1000 kg coil liftable			X		X

L-50M rev. C-EN03-01/02/16

All information in this data sheet is accurate to the best of our knowledge at the time of printing. Please refer to www.lincolnelectric.eu for any updated information. Fumes: Safety Data Sheets (SDS) are available on our website.

L-70

CLASSIFICATION

AWS A5.17	EA1	A-Nr	2	Mat-Nr	1.5424
ISO 14171-A	S2 Mo	F-Nr	6		
		9606 FM	1/3		

GENERAL DESCRIPTION

A 0,5%Mo wire to be used on steel grades such as 16Mo3 or on non alloy steels to improve impact properties when welding in 2-run technique

APPROVALS

	ABS	TÜV	BV	DNV	GL	LRS	RINA	RMRS	PRS
761	X	X	X	X	X	X	X	X	X
780		X				X			X
8500	X				X			X	
860		X	X	X	X	X			
P230	X		X		X	X	X	X	
P223		X							

CHEMICAL COMPOSITION (W%), TYPICAL, WIRE

C	Mn	Si	Mo
0.1	0.9	0.10	0.5

PACKAGING AND AVAILABLE SIZES

Diameter [mm]	2.0	2.4	3.2	4.0	4.8
25 kg stein basket B415+VCI	X	X	X	X	X
100 kg stein basket B785			X	X	
350 kg Speed Feed® Drum	X		X	X	
400 kg Speed Feed® Drum			X	X	
600 kg Speed Feed® Drum				X	
1000 kg coil liftable			X		

L-70 rev. C-EN03-01/02/16

All information in this data sheet is accurate to the best of our knowledge at the time of printing. Please refer to www.lincolnelectric.eu for any updated information. Fumes: Safety Data Sheets (SDS) are available on our website.

LINCOLN
ELECTRIC
THE WELDING EXPERTS®

LNS 133TB

CLASSIFICATION

AWS A5.13	EG	A-Nr	-
ISO 14171-A	SZ	F-Nr	6
		9606 FM	1

GENERAL DESCRIPTION

Titanium and boron micro alloy wire to achieve optimum impact properties with the 2-run technique, especially with pipe mill fluxes

Exclusively for as-welded applications

CHEMICAL COMPOSITION (W%), TYPICAL, WIRE

C	Mn	Si	Ti	B
0.08	1.55	0.25	0.15	0.015

PACKAGING AND AVAILABLE SIZES

Diameter (mm)	3.2	4.0
25 kg stein basket B415+VCI	X	X
350 kg metal reel		X
350 kg Speed Feed® Drum	X	X
400 kg Speed Feed® Drum	X	X
600 kg Speed Feed® Drum	X	X
1000 kg Accutrak® Drum	X	X
1000 kg coil liftable	X	X

LNS 140A

CLASSIFICATION

AWS A5.23	EA2	A-Nr	2	Mat-Nr	1.5424
ISO 14171-A	S2 Mo	F-Nr	6		
ISO 24598-A	S Mo	9606 FM	1/3		

GENERAL DESCRIPTION

A 0,5%Mo wire to be used on steel grades such as 16Mn3 or on non alloy steels to improve impact properties when welding in 2-run technique

APPROVALS

	ABS	TÜV	BV	DNV	GL	LRS	RINA	RMRS	PRS
761	X	X	X	X	X	X	X	X	X
780		X				X			X
8500	X				X			X	
860		X	X	X	X	X			
P230	X	X	X		X	X	X	X	

CHEMICAL COMPOSITION [W%], TYPICAL, WIRE

C	Mn	Si	Mo
0.1	1.0	0.10	0.5

PACKAGING AND AVAILABLE SIZES

Diameter [mm]	1.6	2.0	2.4	3.2	4.0	4.8
15 kg stein basket B415		X	X			
25 kg stein basket B415+VCI		X	X	X	X	X
100 kg stein basket B785				X	X	
250 kg Speed Feed® Drum				X		
300 kg wooden reel		X	X	X		
350 kg metal reel					X	
350 kg Speed Feed® Drum		X		X	X	X
400 kg Speed Feed® Drum				X	X	
600 kg Speed Feed® Drum					X	
600 kg Accutrak® Drum		X				
1000 kg Accutrak® Drum				X	X	
1000 kg coil liftable	X		X	X	X	

LNS 140A rev. C-EN04-01/02/16

All information in this data sheet is accurate to the best of our knowledge at the time of printing. Please refer to www.lincolnelectric.eu for any updated information. Fumes: Safety Data Sheets (SDS) are available on our website.

LNS 140TB

CLASSIFICATION

AWS A5.23	EA2TiB	A-Nr	2
ISO 14171-A	S2MoTiB	F-Nr	6
		9606 FM	1

GENERAL DESCRIPTION

Titanium and boron micro alloy wire to achieve optimum impact properties with the 2-run technique, especially with pipe mill fluxes
Exclusively for as-welded applications

CHEMICAL COMPOSITION (W%), TYPICAL, WIRE

C	Mn	Si	Mo	Ti	B
0.06	1.1	0.20	0.5	0.13	0.02

PACKAGING AND AVAILABLE SIZES

Diameter (mm)	2.4	3.2	3.5	4.0	4.8
25 kg stein basket B415+VCI	X	X		X	X
100 kg stein basket B785				X	
300 kg wooden reel		X			
300 kg Speed Feed® Drum					X
350 kg metal reel				X	X
350 kg Speed Feed® Drum		X		X	
400 kg Speed Feed® Drum				X	
600 kg Speed Feed® Drum		X		X	
1000 kg Accutrak® Drum	X		X	X	
1000 kg coil liftable			X	X	

LNS 140TB rev. C-EN04-01/02/16

All information in this data sheet is accurate to the best of our knowledge at the time of printing. Please refer to www.lincolnelectric.eu for any updated information. Fumes: Safety Data Sheets (SDS) are available on our website.

LNS 150

CLASSIFICATION

AWS A5.23	EB2	A-Nr	3	Mat-Nr	1.7339
ISO 24598-A	S Cr Mo1	F-Nr	6		
		9606 FM	3		

GENERAL DESCRIPTION

A 1,25%Cr/0,5%Mo wire for creep resistant steels such as 13CrMo4-5
 Maximal operating temperature is 550°C
 To be used with basic fluxes such as 8500, P240, 888 or MIL800-H

APPROVALS

TÜV

780	X
860	X

CHEMICAL COMPOSITION (W%), TYPICAL, WIRE

C	Mn	Si	Mo	Cr	P
0.13	0.8	0.15	0.5	1.2	<0.010

PACKAGING AND AVAILABLE SIZES

Diameter (mm)	2.0	2.4	3.2	4.0
25 kg stein basket B415+VCI	X	X	X	X
100 kg stein basket B785	X	X		
350 kg Speed Feed® Drum	X			
1000 kg Accutrak® Drum			X	

LNS 150 rev. C-EN03-01/02/16

All information in this data sheet is accurate to the best of our knowledge at the time of printing. Please refer to www.lincolnelectric.eu for any updated information.
 Fumes: Safety Data Sheets (SDS) are available on our website.

LNS 151

CLASSIFICATION

AWS A5.23	EB3	A-Nr	4	Mat-Nr	1.7339
ISO 24598-A	S Cr Mo2	F-Nr	6		
		9606 FM	3		

GENERAL DESCRIPTION

A 2,5%Cr/1%Mo wire for creep resistant steels such as 10CrMo 9-10

Maximal operating temperature is 600°C

To be used with basic fluxes such as 8500, P240, 888 or MIL800-H

Also usable with active fluxes such as 780, 781, 782 for heat exchanger fillet weld application

APPROVALS

TÜV

780	X
-----	---

CHEMICAL COMPOSITION (W%), TYPICAL, WIRE

C	Mn	Si	Mo	P	Cr
0.10	0.6	0.12	1.0	<0.010	2.5

PACKAGING AND AVAILABLE SIZES

Diameter (mm)	2.0	2.4	3.2	4.0
25 kg stein basket B415+VCI	X	X	X	X
400 kg Speed Feed® Drum				X
1000 kg Accutrak® Drum			X	

LNS 151 rev. C-EN03-01/02/16

All information in this data sheet is accurate to the best of our knowledge at the time of printing. Please refer to www.lincolnelectric.eu for any updated information. Fumes: Safety Data Sheets (SDS) are available on our website.

LNS 160

CLASSIFICATION

AWS A5.23	ENi1	A-Nr	10
ISO 14171-A	S2 Ni1	F-Nr	6
		9606 FM	1/2

GENERAL DESCRIPTION

A 1%Ni wire for application requiring good impact toughness down to -60°C
Optimum results obtained with the multipass technique

APPROVALS

TÜV

P230	X
P240	X

CHEMICAL COMPOSITION (W%), TYPICAL, WIRE

C	Mn	Si	Ni
0.10	1.1	0.15	1.0

PACKAGING AND AVAILABLE SIZES

Diameter (mm)	2.4	3.2	4.0
25 kg stein basket B415+VCI	X	X	X
100 kg stein basket B785			X

LNS 160 rev. C-EN03-01/02/16

All information in this data sheet is accurate to the best of our knowledge at the time of printing. Please refer to www.lincolnelectric.eu for any updated information.
Fumes: Safety Data Sheets (SDS) are available on our website.

LINCOLN
ELECTRIC
THE WELDING EXPERTS®

LNS 162

CLASSIFICATION

AWS A5.23	ENi2	A-Nr	10
ISO 14171-A	S2 Ni2*	F-Nr	6
* Nearest classification		9606 FM	1/2

GENERAL DESCRIPTION

A 2%Ni wire for application requiring excellent impact toughness down to -60°C
Optimum results obtained with the multipass technique

APPROVALS

TÜV

P230	X
P240	X

CHEMICAL COMPOSITION (W%), TYPICAL, WIRE

C	Mn	Si	Ni
0.10	1.1	0.15	2.2

PACKAGING AND AVAILABLE SIZES

Diameter (mm)	2.0	2.4	3.2	4.0
25 kg stein basket B415+VCI		X	X	X
300 kg wooden reel	X			

LNS 163

CLASSIFICATION

AWS A5.23	EG	A-Nr	10
ISO 14171-A	S2 NiCu	F-Nr	6
		9606 FM	2

GENERAL DESCRIPTION

Submerged arc wire with Cu and Ni addition dedicated to weathering steel assembly like Cor-Ten grades
 Matching corrosion resistance as well as colour
 To be used with 960, 860 or P230 flux in most of the applications
 Can be used in butt welds single run or multi runs as well as in fillet welds

APPROVALS

TÜV

860	X
-----	---

CHEMICAL COMPOSITION (W%), TYPICAL, WIRE

C	Mn	Si	Ni	Cu	Cr	S	P
0.11	1.0	0.25	0.7	0.5	0.2 max	0.2 max	0.2 max

PACKAGING AND AVAILABLE SIZES

Diameter (mm)	2.0	2.4	3.2	4.0
25 kg stein basket B415+VCI	X	X	X	X
350 kg Speed Feed® Drum		X		
400 kg Speed Feed® Drum	X	X	X	X

LNS 163 rev. C-EN03-01/02/16

All information in this data sheet is accurate to the best of our knowledge at the time of printing. Please refer to www.lincolnelectric.eu for any updated information.
 Fumes: Safety Data Sheets (SDS) are available on our website.

LNS 164

CLASSIFICATION

AWS A5.23	EF3	A-Nr	10
ISO 14171-A	S3 Ni1Mo	F-Nr	6
		9606 FM	2

GENERAL DESCRIPTION

Nickel and Molybdenum alloy wire to reach both high yield/ tensile properties and good impact toughness at low temperatures

Optimum results obtained with the multipass technique

Meets NACE requirement

APPROVALS

TÜV

P230	X
P240	X

CHEMICAL COMPOSITION (W%), TYPICAL, WIRE

C	Mn	Si	Ni	Mo
0.10	1.75	0.10	0.9	0.5

PACKAGING AND AVAILABLE SIZES

Diameter (mm)	2.4	3.2	4.0
25 kg stein basket B415+VCI	X	X	X
300 kg wooden reel			X
350 kg Speed Feed® Drum	X		X
400 kg Speed Feed® Drum		X	X

LNS 164 rev. C-EN03-01/02/16

All information in this data sheet is accurate to the best of our knowledge at the time of printing. Please refer to www.lincolnelectric.eu for any updated information. Fumes: Safety Data Sheets (SDS) are available on our website.

LNS 165

CLASSIFICATION

AWS A5.23	ENi5	A-Nr	10
ISO 14171-A	SZ	F-Nr	6
		9606 FM	2

GENERAL DESCRIPTION

Nickel and Molybdenum alloyed wire to reach both high yield/ tensile properties and good impact toughness at low temperatures

Optimum results obtained with the multipass technique

APPROVALS

	TÜV	ABS	DNV	LRS
P240	X	X	X	X

CHEMICAL COMPOSITION (W%), TYPICAL, WIRE

C	Mn	Si	Ni	Mo
0.08	1.4	0.20	1.0	0.2

PACKAGING AND AVAILABLE SIZES

Diameter [mm]	2.0	2.4	3.2	4.0	4.8
25 kg stein basket B415+VCI	X	X	X	X	X
100 kg stein basket B785				X	
400 kg Speed Feed® Drum			X		
1000 kg Accutrak® Drum				X	

LNS 165 rev. C-EN03-01/02/16

All information in this data sheet is accurate to the best of our knowledge at the time of printing. Please refer to www.lincolnelectric.eu for any updated information. Fumes: Safety Data Sheets (SDS) are available on our website.

LINCOLN
ELECTRIC
THE WELDING EXPERTS®

LNS 168

CLASSIFICATION

ISO 26304-A	S 3Ni2.5CrMo	A-Nr	12
		F-Nr	6
		9606 FM	2

GENERAL DESCRIPTION

Low alloy solid wire dedicated to high strength steel grades (Re>690MPa)
Good impact properties guaranteed down to -40°C when combined with a basic flux

APPROVALS

LRS

P240 X

CHEMICAL COMPOSITION (W%), TYPICAL, WIRE

C	Mn	Si	Ni	Mo	Cr
0.10	1.6	0.15	2.3	0.6	0.7

PACKAGING AND AVAILABLE SIZES

Diameter (mm)	2.5	3.2	4.0	5.0
25 kg stein basket B415+VCI	X	X	X	X
1000 kg coil		X	X	

LNS 168 rev. C-EN02-01/02/16

All information in this data sheet is accurate to the best of our knowledge at the time of printing. Please refer to www.lincolnelectric.eu for any updated information.
Fumes: Safety Data Sheets (SDS) are available on our website.

LNS 175

CLASSIFICATION

AWS A5.23	ENi3	A-Nr	10
ISO 14171-A	S2Ni3	F-Nr	6
		9606 FM	1

GENERAL DESCRIPTION

A 3,5Ni wire used on cryogenic steels such as SA203Gr or 12Ni14

CHEMICAL COMPOSITION (W%), TYPICAL, WIRE

C	Mn	Si	Ni
0.08	1.0	0.1	3.5

PACKAGING AND AVAILABLE SIZES

Diameter (mm)	3.2	4.0
25 kg stein basket B415+VCI	X	X

LNS 175: rev. C-EN02-01/02/16

All information in this data sheet is accurate to the best of our knowledge at the time of printing. Please refer to www.lincolnelectric.eu for any updated information. Fumes: Safety Data Sheets (SDS) are available on our website.

LNS T55

CLASSIFICATION

AWS A5.17	EC1 H4	A-Nr	1
ISO 14171-A	TZ	F-Nr	6
		9606 FM	1/2

GENERAL DESCRIPTION

Unalloy basic flux cored wire for subarc applications.
 Higher deposition compared to equivalent solid wire size
 Good impact properties at low temperatures when combined with P230 flux.

CHEMICAL COMPOSITION (W%), TYPICAL, WIRE

C	Mn	Si	P	S
0.06	1.5	0.6	<0.020	0.015

PACKAGING AND AVAILABLE SIZES

Diameter [mm]	2.8
25 kg stein basket B415+VCI	X
250 kg metal coil	X

LNS 304L

CLASSIFICATION

AWS A5.9	ER308L	A-Nr	8	Mat-Nr	1.4316
ISO 14343-A	S 19 9 L	F-Nr	6		
		9606 FM	5		

GENERAL DESCRIPTION

Low carbon austenitic stainless steel wire suitable for 304L base material grade or 321 grade in some applications
Recommended with P2007 and P2000 fluxes.

APPROVALS

	TÜV	ABS	LRS
P2000	X		
P2007	X	X	X

CHEMICAL COMPOSITION (W%), TYPICAL, WIRE

C	Mn	Si	Cr	Ni	Mo
0.015	1.8	0.4	20	10	0.1

PACKAGING AND AVAILABLE SIZES

Diameter (mm)	2.0	2.4	3.2	4.0
25 kg stein basket B415+VCI	X	X	X	X

LNS 304L: rev. C-EN03-01/02/16

All information in this data sheet is accurate to the best of our knowledge at the time of printing. Please refer to www.lincolnelectric.eu for any updated information.
Fumes: Safety Data Sheets (SDS) are available on our website.

LNS 304H

CLASSIFICATION

AWS A5.9	ER308H	A-Nr	8	Mat-Nr	1.4948
ISO 14343-A	S 19 9 H	F-Nr	6		
		9606 FM	5		

GENERAL DESCRIPTION

High carbon austenitic stainless steel wire for high temperature applications (up to 730°C). Suitable for 304 base material grade

Recommended with P2007 and P2000 fluxes

CHEMICAL COMPOSITION (W%), TYPICAL, WIRE

C	Mn	Si	Ni	Cr
0.05	1.2	0.6	10.5	20.1

PACKAGING AND AVAILABLE SIZES

Diameter (mm)	2.4	3.2
25 kg stein basket B415+VCI	X	X

LNS 307

CLASSIFICATION

AWS A5.9	ER307*	A-Nr	8	Mat-Nr	1.4370
ISO 14343-A	S 18 8Mn	F-Nr	6		
* Nearest classification		9606 FM	5		

GENERAL DESCRIPTION

Stainless steel wire for high manganese content base materials, difficult-to-weld steels such as armour plates, and dissimilar joints

Weld deposit features strain hardenability

Recommended with P2007 and P2000 fluxes

CHEMICAL COMPOSITION (W%), TYPICAL, WIRE

C	Mn	Si	Cr	Ni
0.07	7.0	0.6	19	8.9

PACKAGING AND AVAILABLE SIZES

Diameter (mm)	2.4	3.2	4.0
25 kg stein basket B415+VCI	X	X	X

LNS 307: rev. C-EN03-01/02/16

All information in this data sheet is accurate to the best of our knowledge at the time of printing. Please refer to www.lincolnelectric.eu for any updated information.
Fumes: Safety Data Sheets (SDS) are available on our website.

LINCOLN
ELECTRIC
THE WELDING EXPERTS®

LNS 309L

CLASSIFICATION

AWS A5.9	ER309L	A-Nr	8	Mat-Nr	1.4332
ISO 14343-A	S 23 12 L	F-Nr	6		
		9606 FM	5		

GENERAL DESCRIPTION

Low carbon austenitic stainless steel wire suitable for dissimilar welding applications
Recommended with P2007 and P2000 fluxes

APPROVALS

	TÜV	ABS	LR5
P2000S	X		X
P2007	X	X	X

CHEMICAL COMPOSITION (W%), TYPICAL, WIRE

C	Mn	Si	Ni	Cr	Mo
0.01	1.8	0.4	13.8	23.4	0.07

PACKAGING AND AVAILABLE SIZES

Diameter (mm)	2.0	2.4	3.2	4.0
25 kg stein basket B415+VCI	X	X	X	X

LNS 316L

CLASSIFICATION

AWS A5.9	ER316L	A-Nr	8	Mat-Nr	1.4430
ISO 14343-A	S 19 12 3 L	F-Nr	6		
		9606 FM	5		

GENERAL DESCRIPTION

Low carbon stainless steel wire suitable for 316L base material and similar grades
Recommended with P2007 and P2000 fluxes

APPROVALS

	TÜV	ABS	LRS
P2000	X		X
P2007	X	X	X

CHEMICAL COMPOSITION (W%), TYPICAL, WIRE

C	Mn	Si	Cr	Ni	Mo
0.015	1.75	0.4	18.5	12	2.75

PACKAGING AND AVAILABLE SIZES

Diameter (mm)	2.0	2.4	3.2	4.0
25 kg stein basket B415+VCI	X	X	X	X

LNS 316L: rev. C-EN03-01/02/16

All information in this data sheet is accurate to the best of our knowledge at the time of printing. Please refer to www.lincolnelectric.eu for any updated information.
Fumes: Safety Data Sheets (SDS) are available on our website.

LNS 318

CLASSIFICATION

AWS A5.9	ER318	A-Nr	8	Mat-Nr	1.4576
ISO 14343-A	S 19 12 3 Nb	F-Nr	6		
		9606 FM	5		

GENERAL DESCRIPTION

Stabilized stainless steel wire suitable for 316Ti and similar grades
Recommended with P2007 and P2000 fluxes

APPROVALS

TÜV

P2000 X

CHEMICAL COMPOSITION (W%), TYPICAL, WIRE

C	Mn	Si	Ni	Cr	Mo	Nb
0.04	1.7	0.4	11.3	19.5	2.6	0.5

PACKAGING AND AVAILABLE SIZES

Diameter (mm)	2.0	2.4	3.2	4.0
25 kg stein basket B415+VCI	X	X	X	X

LNS 318: rev. C-EN02-01/02/16

All information in this data sheet is accurate to the best of our knowledge at the time of printing. Please refer to www.lincolnelectric.eu for any updated information. Fumes: Safety Data Sheets (SDS) are available on our website.

LNS 347

CLASSIFICATION

AWS A5.9	ER347	A-Nr	8	Mat-Nr	1.4551
ISO 14343-A	S 19 9 Nb	F-Nr	6		
		9606 FM	5		

GENERAL DESCRIPTION

Stabilized stainless steel wire suitable for 347, 321 and similar grades
Recommended with P2007 and P2000 fluxes

APPROVALS

TÜV

P2000 X

CHEMICAL COMPOSITION (W%), TYPICAL, WIRE

C	Mn	Si	Ni	Cr	Mo	Nb
0.03	1.6	0.4	9.7	19.5	0.1	0.6

PACKAGING AND AVAILABLE SIZES

Diameter (mm)	2.4	3.2	4.0
25 kg stein basket B415+VCI	X	X	X
300 kg Speed Feed Drum	X		

LNS 347: rev. C-EN04-11/05/16

All information in this data sheet is accurate to the best of our knowledge at the time of printing. Please refer to www.lincolnelectric.eu for any updated information.
Fumes: Safety Data Sheets (SDS) are available on our website.

LNS 4455

CLASSIFICATION

		A-Nr	9	Mat-Nr	1.4455
ISO 14343-A	S 20 16 3 Mn L	F-Nr	6		
		9606 FM	5		

GENERAL DESCRIPTION

Fully austenitic stainless steel wire

To be used for cryogenic application or with non magnetic stainless steels

Recommended with P2007, P2000 and P7000 fluxes

APPROVALS

TÜV

P2000 X

CHEMICAL COMPOSITION (W%), TYPICAL, WIRE

C	Mn	Si	Cr	Ni	Mo	N
0.01	7.0	0.4	20	16	2.7	0.16

PACKAGING AND AVAILABLE SIZES

Diameter (mm)	2.4	3.2
25 kg stein basket B415+VCI	X	X

LNS 4455: rev. C-EN02-01/02/16

All information in this data sheet is accurate to the best of our knowledge at the time of printing. Please refer to www.lincolnelectric.eu for any updated information. Fumes: Safety Data Sheets (SDS) are available on our website.

LNS 4462

CLASSIFICATION

AWS A5.9	ER2209	A-Nr	9	Mat-Nr	1.4462
ISO 14343-A	S 22 9 3 N L	F-Nr	6		
		9606 FM	5		

GENERAL DESCRIPTION

Duplex stainless steel wire suitable for 1.4462 base material and similar grades
Recommended with P2007 and P2000 fluxes

APPROVALS

	TÜV	ABS	LRS
P2000S	X		
P2007	X	X	X

CHEMICAL COMPOSITION (W%), TYPICAL, WIRE

C	Mn	Si	Ni	Cr	Mo	N
0.015	1.6	0.5	8.6	23	3.1	0.16

PACKAGING AND AVAILABLE SIZES

Diameter (mm)	2.4	3.2
25 kg stein basket B450	X	X

LNS 4462: rev. C-EN02-01/02/16

All information in this data sheet is accurate to the best of our knowledge at the time of printing. Please refer to www.lincolnelectric.eu for any updated information.
Fumes: Safety Data Sheets (SDS) are available on our website.

LNS 4500

CLASSIFICATION

AWS A5.9	ER385	A-Nr	9	Mat-Nr	1.4519
ISO 14343-A	G 20 25 5 Cu L	F-Nr	6		
		9606 FM	5		

GENERAL DESCRIPTION

Fully austenitic stainless steel wire

To be used for cryogenic application or with non magnetic stainless steels

Recommended with P2007, P2000 and P7000 fluxes

CHEMICAL COMPOSITION (W%), TYPICAL, WIRE

C	Mn	Si	Cr	Ni	Mo	Cu
0.01	1.8	0.3	20	25.2	4.6	1.5

PACKAGING AND AVAILABLE SIZES

Diameter (mm)	2.4
25 kg stein basket B450	X

LNS 4500: rev. C-EN02-01/02/16

All information in this data sheet is accurate to the best of our knowledge at the time of printing. Please refer to www.lincolnelectric.eu for any updated information. Fumes: Safety Data Sheets (SDS) are available on our website.

LNS Zeron[®] 100X

CLASSIFICATION

AWS A5.9	ER2594	A-Nr	8
ISO 14343-A	S 25 9 4 N L	F-Nr	6
		9606 FM	5

GENERAL DESCRIPTION

Superduplex stainless steel wire suitable for Zeron[®] 100 base material and similar grades
Recommended with P2007, P2000 or P7000 flux

CHEMICAL COMPOSITION (W%), TYPICAL, WIRE

C	Mn	Si	Ni	Cr	Mo	N	Cu	W
0.02	0.7	0.3	9.3	25	3.7	0.23	0.6	0.6

PACKAGING AND AVAILABLE SIZES

Diameter (mm)	1.6	2.4
25 kg stein basket B415+VCI	X	X

LNS Zeron[®] 100X: rev. C-EN02-01/02/16

All information in this data sheet is accurate to the best of our knowledge at the time of printing. Please refer to www.lincolnelectric.eu for any updated information.
Fumes: Safety Data Sheets (SDS) are available on our website.

LINCOLN
ELECTRIC
THE WELDING EXPERTS[®]

LNS NiCr 60/20

CLASSIFICATION

AWS A5.14	ERNiCrMo-3	A-Nr	-	Mat-Nr	2.4831
ISO 18274	G 20 25 5 Cu L	F-Nr	43		
		9606 FM	6		

GENERAL DESCRIPTION

Ni-base solid wire for welding nickel alloys
 Excellent resistance to various corrosion forms
 Also used for 9%Ni applications
 Recommended with P2007 flux

CHEMICAL COMPOSITION (W%), TYPICAL, WIRE

C	Mn	Si	Cr	Ni	Mo	Nb	Fe
0.05	0.02	0.1	22	65	8.7	3.7	0.1

PACKAGING AND AVAILABLE SIZES

Diameter (mm)	1.6	2.0	2.4
25 kg stein basket B450	X	X	X

SAW

LNS NiCr 60/20: rev. C-EN02-01/02/16

All information in this data sheet is accurate to the best of our knowledge at the time of printing. Please refer to www.lincolnelectric.eu for any updated information. Fumes: Safety Data Sheets (SDS) are available on our website.

LNS NiCro 70/19

CLASSIFICATION

AWS A5.14	ERNiCr-3	A-Nr	-	Mat-Nr	2.4806
ISO 18274	S Ni 6082 (NiCr20Mn3Nb)	F-Nr	43		
		9606 FM	6		

GENERAL DESCRIPTION

Ni-base solid wire for welding high Ni alloyed materials such as alloy 600 and alloy 601
 High resistance to oxidation at high temperatures
 Recommended with P2007 flux

CHEMICAL COMPOSITION (W%), TYPICAL, WIRE

C	Mn	Si	Cr	Ni	Nb	Fe
0.03	3.1	0.08	20.5	72.5	2.6	0.8

PACKAGING AND AVAILABLE SIZES

Diameter (mm)	2.4
25 kg stein basket B450	X

LNS NiCro 70/19; rev. C-EN01-01/02/16

All information in this data sheet is accurate to the best of our knowledge at the time of printing. Please refer to www.lincolnelectric.eu for any updated information.
 Fumes: Safety Data Sheets (SDS) are available on our website.



LNS NiCrMo 60/16

CLASSIFICATION

AWS A5.14	ERNiCrMo-4	A-Nr	-	Mat-Nr	2.4886
ISO 18274	S Ni 6276 (NiCr15Mo16Fe6W4)	F-Nr	43		
		9606 FM	6		

GENERAL DESCRIPTION

Ni-base solid wire for welding CrMoW alloyed nickel alloys
 Extreme resistance to corrosion environments containing sulphuric acid and chlorides
 Also used for 9%Ni applications
 Recommended with P2007 flux

CHEMICAL COMPOSITION (W%), TYPICAL, WIRE

C	Mn	Si	Ni	Cr	Mo	W	Fe
0.006	0.5	0.04	58	16	16	3.6	5.8

PACKAGING AND AVAILABLE SIZES

Diameter (mm)	1.6	2.4
25 kg stein basket B415+VCI	X	X

LNS NiCrMo 60/16; rev. C-EN02-01/02/16

All information in this data sheet is accurate to the best of our knowledge at the time of printing. Please refer to www.lincolnelectric.eu for any updated information. Fumes: Safety Data Sheets (SDS) are available on our website.

761/761-CG

CLASSIFICATION

Flux	Flux/wire			
ISO 14174 S A CS/MS 1 88 AC H5	761 / L-60	AWS A5.17 / A5.23	ISO 14171-A : MR	ISO 14171-A : TR
	761 / L-61	F7A2-EL12	S 38 2 CS/MS S1	
	761 / LNS 140A	F7A2-EM12K	S 42 2 CS/MS S2Si	S 4T 0 CS/MS S2Si
	761 / L-70	F9A0-EA2-G	S 50 0 CS/MS S2Mo	S 4T 2 CS/MS S2Mo
		F9A0-EA1-G	S 50 0 CS/MS S2Mo	S 4T 2 CS/MS S2Mo

GENERAL DESCRIPTION

- High current capacity
- Active flux for limited pass welding
- High restraint cracking resistant
- Suitable for rusty/dirty plates (at high current)
- Applicable for low quality steels
- Coarse grain flux more suitable with the most rusty and dirty plates

APPROVALS

Wire grade	ABS	BV	CRS	DNV	PRS	GL	LRS	RINA	RMRS	TÜV
L-60										✓
LNS 135										✓
L-61	3YM/2YT	3YM/2YT	3YM/2YT	2YT	3YM/2YT	3YM/2YT	3YM/2YT	3YM/2YT	2YT	✓
LNS 140A (L-70)	3Y40M/3Y40T	3Y40M/3Y40T		3Y40M/3Y40T	3Y40M/2Y40T	3Y40M/3Y40T	3Y40M/3Y40T	3Y40M/3Y40T	3Y40M/3Y40T	✓

CHEMICAL COMPOSITION (W%), TYPICAL, ALL WELD METAL

Wire grade	C	Mn	Si	P	S	Mo
L-60	0.05	1.5	0.7	<0.03	<0.025	
L-61	0.08	1.7	0.9	<0.03	<0.025	
LNS 140A (L-70)	0.06	1.7	0.8	<0.03	<0.025	0.4

MECHANICAL PROPERTIES, TYPICAL, ALL WELD METAL

Wire grade	Condition*	Yield strength (N/mm ²)	Tensile strength (N/mm ²)	Elongation (%)	Impact ISO-V(J)	
					0°C	-20°C
L-60	MR	380	500	28	80	50
L-61	MR	440	530	28	100	50
	TR	>420	>540		65	
LNS 140A (L-70)	MR	480	600		80	40
	TR	>440	>540		100	55

* MR : Multirun - TR : Two-run

761/761-CG.rev.C-EN25-01/02/16

761/761-CG

EXAMPLES OF MATERIALS TO BE WELDED

Code	Type/ Steel grades	Limited passes		
		L-60	L-61	LNS 140A (L-70)
Ship plates				
	A to D, A (H) 32 to D(H) 36	✓	✓	✓
General structural steels				
EN 10025 part 6	500 A			✓
EN 10025 part 3/part 4	S275 to S420, N,M	✓	✓	✓
EN 10149	S315 to S420, MC	✓	✓	✓
	S315 to S420, NC	✓	✓	✓
	S460, MC & NC			✓
EN 10025 part 2	S185 to S355, E295 to E360, JR(G1 & G2), J0, J2 (G3&G4)	✓	✓	✓
Boiler & pressure vessel steels				
EN 10028	P235 to P420, GH N, NH, M, Q & QH	✓	✓	✓
	P235 to P460, GH, N, NH, M, Q & QH	✓	✓	✓
	P500, GH, N, NH, M, Q & QH, P235 S, P265 S	✓	✓	✓
	A37 to A52, CP, AP	✓	✓	✓

FLUX CHARACTERISTICS

Current type	DC/AC
Basicity (Boniszewski)	0.8
Solidification speed	Low, viscous slag
Density (kg/dm ³)	1.2
Grain size (ISO 14174)	761 : 1 -16 / 761-CG : 1 - 20

SUGGESTIONS FOR USE

Wire	Characteristics
L-60	To prevent defects from organic components
L-61	Reliable properties
LNS 140A (L-70)	For good impact toughness in two-run as welded

Applications

Flat fillet, large throat
Butt joints in two passes, in medium and thick plates
Flux backing, modified series arc welding

PACKAGING AND AVAILABLE SIZES

Unit	Net weight (kg)
Bag	25
Metal drum	250
Big Bag	500 / 1000

780/780-CG/780-FG

CLASSIFICATION

Flux	Flux/wire			
ISO 14174 S A AR/AB 1 78 AC H5		AWS A5.17 / A5.23	ISO 14171-A : MR	ISO 14171-A : TR
	780 / L-60	F7A0-EL12	S 42 0 AR/AB S1	S 4T 0 AR/AB S1
	780 / L-61	F7A2-EM12K	S 42 0 AR/AB S2Si	S 4T 2 AR/AB S2Si
	780 / LNS 140A	F8A2-EA2-G		S 4T 2 AR/AB S2Mo
	780 / L-70	F8A2-EA1-G		S 4T 2 AR/AB S2Mo

GENERAL DESCRIPTION

Active flux for limited pass welding

Good general purpose flux, including semi-automatic

High speed on dirty plate

Good resistance to porosity on rust and primer

Good slag removal, good bead shape

Product also available in a fine grain and coarse formula

Fine grain formula preferably used on high speed fillet welds applications

Good on circumferential welds on small diameters with low voltage

APPROVALS

Wire grade	BV	ABS	LRS	DNV	GL	RINA	PRS	RMRS	CRS	TÜV
L-60	A2YT	2YT	2YT	2YT	3YT	2YT				✓
LNS 135										✓
L-61	A3YT		2YM/3YT	2YM/3YT	3YT	3YT	2YM/3YT	3YT	3YT	✓
L-50-M (LNS 133U)										✓
LNS 140A (L-70)			3YT				3YT			✓
LNS 150										✓
LNS 151										✓

CHEMICAL COMPOSITION (W%), TYPICAL, ALL WELD METAL

Wire grade	C	Mn	Si	P	S	Mo
L-60	0.07	1.4	0.6	<0.03	<0.025	
L-61	0.07	1.6	0.7	<0.03	<0.025	
LNS 140A (L-70)	0.07	1.6	0.6	<0.03	<0.025	0.4

MECHANICAL PROPERTIES, TYPICAL, ALL WELD METAL

Wire grade	Condition*	Yield strength (N/mm ²)	Tensile strength (N/mm ²)	Elongation (%)	Impact ISO-V(J)	
					0°C	-20°C
L-60	MR	>420	510	28	50	
L-61	TR	>420	>540	28		50
LNS 140A (L-70)	TR	>420	>550	25		60

* MR : Multirun - TR : Two-run

780/780-CG/780-FG: rev. C-EN24-01/02/16

All information in this data sheet is accurate to the best of our knowledge at the time of printing. Please refer to www.lincolnelectric.eu for any updated information.
Fumes: Safety Data Sheets (SDS) are available on our website.

780 / 780-CG / 780-FG

EXAMPLES OF MATERIALS TO BE WELDED

Code	Type/ Steel grades	Limited passes		
		L-60	L-61	LNS 140A (L-70)
Ship plates				
	A to D, A (H) 32 to D(H) 36	✓	✓	✓
General structural steels				
EN 10025 part 6	500 A			✓
EN 10025 part 3/part 4	S275 to S420, N,M	✓	✓	✓
EN 10149	S315 to S420, MC	✓	✓	✓
	S315 to S420, NC	✓	✓	✓
	S460, MC & NC			✓
EN 10025 part 2	S185 to S355, E295 to E360, JR(G1 & G2), J0, J2 (G3&G4)	✓	✓	✓
Boiler & pressure vessel steels				
EN 10028	P235 to P420, GH, N, NH, M, Q & QH	✓	✓	✓
	P235 to P460, GH, N, NH, M, Q & QH	✓	✓	✓
	P500, GH, N, NH, M, Q & QH, P235 S, P265 S	✓	✓	✓
	A37 to A52, CP, AP	✓	✓	✓

FLUX CHARACTERISTICS

Current type	DC/AC
Basicity (Boniszewski)	0.7
Solidification speed	High
Density (kg/dm ³)	1.4
Grain size (ISO 14174)	780 : 1 - 20 / 780-CG : 2 - 20 / 780-FG : 1 - 16

SUGGESTIONS FOR USE

Wire	Characteristics
L-60	To prevent defects from organic components
L-61	Reliable properties
LNS 140A (L-70)	For good impact toughness in two-run as welded

PACKAGING AND AVAILABLE SIZES

Unit	Net weight (kg)
Bag	25
Sahara ReadyBag™ (SRB)	25
Metal drum	250
Big Bag	500 / 1000

CLASSIFICATION

Flux	Flux/wire		
ISO 14174 S A ZS 1 87 AC H5		AWS A5.17 / A5.23	ISO 14171-A : TR
	781 / L-60	F7A0-EL12	
	781 / L-61	F7A0-EM12K	S 4T 0 ZS S2Si
	781 / L-50M (LNS 133U)		S 4T 2 ZS S3Si
	761 / LNS 140A		S 4T 2 ZS S2Mo

GENERAL DESCRIPTION

Active flux for limited pass welding
 Very high speed on sheet metal
 Good impact in two-run technique
 High speed fillet weld with very good bead profile
 Shiny and smooth appearance

APPROVALS

Wire grade	BV	ABS	LRS	DNV	RINA	TÜV
L-50M (LNS 133U)	A3Y40T	3Y400T	3Y40T	3Y40T	3Y40T	✓
L-60						✓
L-61						✓

CHEMICAL COMPOSITION (W%), TYPICAL, ALL WELD METAL

Wire grade	C	Mn	Si	P	S	Mo
L-61	0.05	1.3	0.9	<0.03	<0.02	
L-50M (LNS 133U)	0.06	1.6	1.0	<0.03	<0.02	
LNS 140A (L-70)	0.06	1.3	0.9	<0.03	<0.02	0.4

MECHANICAL PROPERTIES, TYPICAL, ALL WELD METAL

Wire grade	Condition*	Yield strength [N/mm ²]	Tensile strength [N/mm ²]	Impact ISO-V(J)
				-20°C
L-61	TR	>420	>540	50
L-50M(LNS 133U)	TR	>450	>560	60
LNS 140A (L-70)	TR	>490	>580	65

* MR : Multirun - TR : Two-run

781: rev. C-EN25-01/02/16

781

EXAMPLES OF MATERIALS TO BE WELDED

Code	Type/ Steel grades	Limited passes		
		L-60	L-61	LNS 140A
Ship plates				
	A to D, AH32 to DH40	✓	✓	✓
	A to E, AH32 to EH40			✓
General structural steels				
EN 10025 part 6	500 & 500 A	✓	✓	✓
	500 & 550 A & AL			✓
EN 10025 part 3/part 4	S275 to S460 N/M	✓	✓	✓
	S275 to S460 all qualities			✓
EN 10149	S315 to S600 MC & NC	✓	✓	✓
EN 10025 part 2	S185 to S360 all qualities	✓	✓	✓
Boiler & pressure vessel steels				
EN 10028	P235 to P460, [GH, N NH, M, ML1]	✓	✓	✓
	P235 to P460 all qualities			✓
EN 10207	P235 to P275 S	✓	✓	✓
A36-601 & NF A36-605	A37 to A52 [CP, AP]	✓	✓	✓
	A37 to A52 [CP, AP, FP]			✓

FLUX CHARACTERISTICS

Current type	DC/AC
Basicity (Boniszewski)	0.7
Solidification speed	Fast, fluid slag
Density (kg/dm ³)	1.5
Grain size (ISO 14174)	1 -16

SUGGESTIONS FOR USE

Wire	Characteristics
L-60	High speeds on clean plate
L-61	Very high speeds

PACKAGING AND AVAILABLE SIZES

Unit	Net weight (kg)
Bag	25
Sahara ReadyBag™ (SRB)	25
Metal drum	250

782 / 782-FG

CLASSIFICATION

Flux	Flux/wire			
ISO 14174 S A AR/AB 176 AC H5	782 / L-60	AWS A5.17 / A5.23	ISO 14171-A : MR	ISO 14171-A : TR
	782 / LNS 135	F7AZ-EM12	S 42 A AR/AB S1	S 4T A AR/AB S1
	782 / L-61	F7AZ-EM12K	S 46 0 AR/AB S2Si	S 4T 0 AR/AB S2
	782 / L-50M (LNS133U)		S 46 0 AR/AB S3Si	S 4T 0 AR/AB S2Si
	761 / LNS 140A (L-70)		S 46 0 AR/AB S2Mo	S 5T 2 AR/AB S3Si
				S 5T 2 AR/AB S2Mo

GENERAL DESCRIPTION

Active flux for limited pass welding
Good bead shape with optimum wetting
High speed on thin plates
Single & multi-wire welding; butt and fillet welds
Optimal flux for tin-tube welding, especially with the fine grain formulation

APPROVALS

Wire grade	BV	ABS	DNV	RINA	TÜV
L-50M (LNS 133U)	3Y40T	3Y400T	4Y40T	3Y40T	
LNS 135					✓

CHEMICAL COMPOSITION (W%), TYPICAL, ALL WELD METAL

Wire grade	C	Mn	Si	P	S	Mo
L-60	0.07	1.0	0.6	<0.03	<0.025	
LNS 135	0.07	1.15	0.7	<0.03	<0.025	
L-61	0.07	1.15	0.8	<0.03	<0.025	
L-50M (LNS 133U)	0.06	1.7	1.0	<0.03	<0.025	
LNS 140A (L-70)	0.07	1.2	0.7	<0.03	<0.025	0.4

MECHANICAL PROPERTIES, TYPICAL, ALL WELD METAL

Wire grade	Condition*	Yield strength (N/mm ²)	Tensile strength (N/mm ²)	Impact ISO-V(J)	
				0°C	-20°C
L-60	TR	>420	>520	45	
LNS 135	TR	>420	>520	55	
L-61	TR	>420	>520	60	
L-50M (LNS 133U)	TR	>460	>550	65	50
LNS 140A (L-70)	TR	>460	>600	70	50

* MR : Multirun - TR : Two-run

782/782-FG; rev. C-EN25-01/02/16

782 / 782-FG

EXAMPLES OF MATERIALS TO BE WELDED

Code	Type / Steel grades	Limited passes	
		LNS 135	L-61
Ship plates			
	A, AH32 to AH40		✓
General structural steels			
EN 10149	S315 to S460 MC	✓	✓
EN 10025 part 2	S185 to S355 quality, JR(G1&G2)	✓	✓
	S185 to S355 quality, JR(G1&G2), J10		✓
	E2956 to E360	✓	✓
Boiler & pressure vessel steels			
EN 10028	P235 to 275 GH		✓
	P355 to P460M		✓
A36-601 & NF A36-605	A37 to A52 (CP)		✓

FLUX CHARACTERISTICS

Current type	DC / AC
Basicity (Boniszewski)	0.4
Solidification speed	High
Density (kg/dm ³)	1.4
Grain size (ISO 14174)	782 : 1 - 20 / 782-FG : 1 - 16

SUGGESTIONS FOR USE

Wire	Characteristics
LNS 135	Limited hardness
L-61	Good properties
L-50M (LNS 133U)	Very high speeds

Applications

- Fillet weld, lap joint
- truck wheels
- gas bottles
- Tube to fin fillet weld
- Boiler tubes

PACKAGING AND AVAILABLE SIZES

Unit	Net weight (kg)
Bag	25
Metal drum	250
Big Bag	500 / 1000

708GB

CLASSIFICATION

Flux	Flux/wire		
ISO 14174		AWS A5.23	ISO 14171-A
S A AR 1 99 AC H10	708GB / L-60	F7A0 - EL12	S 42 0 AR S1
	708GB / L-61	F7A0 - EM12K	S 42 0 AR S2Si

GENERAL DESCRIPTION

Agglomerated flux for submerged arc welding, with Mn and Si additions
 Excellent weldability, slag removal, resistance to porosity and cracks, and very good appearance of weld bead.
 It is a good choice for square edge welding joints, fillet welds and lap welds.
 Recommended for limited amount of passes.

CHEMICAL COMPOSITION (W%), ALL WELD METAL

Wire grade	C	Mn	Si	P	S
L-60	0.08	1.4	0.75	0.023	0.02
L-61	0.09	1.6	0.90	0.023	0.02

MECHANICAL PROPERTIES, TYPICAL, ALL WELD METAL

Wire grade	Condition	Yield strength (N/mm ²)	Tensile strength (N/mm ²)	Elongation (%)	Impact ISO-V(J)
					-18°C
L-60	MR	470	570	33	30
L-61	MR	570	645	30	50

APPLICATION

It is typically used for welding gas bottles, truck wheels, structural shapes, joining plates, pieces of small diameter.

EXAMPLES OF MATERIALS TO BE WELDED

Code	Type / Steel grades	Limited passes
		L-61
Gas cylinders		
EN 10120	P245NB	✓
	P265NB	✓
	P310NB	✓
	P355NB	✓

PACKAGING AND AVAILABLE SIZES

Unit	Net weight (kg)
Bag	25

708GB; rev.C-EN03-24/06/16

802

CLASSIFICATION

Flux	Flux/wire	
ISO 14174		
S A CS 1 55 DC H5	Hardfacing flux cored wire	no AWS and EN classification
	Hardfacing solid wire	no AWS and EN classification

GENERAL DESCRIPTION

Neutral flux for hardfacing applications in combination with flux cored wire as Lincore 102W, Lincore 423L and Lincore 423Cr.

Weld metal with min. 0.2% Si and additional V, Nb, Ti and higher Cr-content when combined with previous mentioned Lincore wires.

Excellent slag removal and good bead appearance

Very suitable for hardfacing applications on plates and caster rolls

CHEMICAL COMPOSITION (W%), TYPICAL, ALL WELD METAL

Wire grade	C	Mn	Si	Cr	Ni	Mo	V	W
LINCORE 102W	0.28	1.5	0.4	6.5		1.0	0.15	1.0
LINCORE 423L	0.15	1.2	0.4	11.5	2.0	1.0	0.15	
LINCORE 423Cr	0.15	1.2	0.4	13.5	2.0	1.0	0.15	

MECHANICAL PROPERTIES, TYPICAL, ALL WELD METAL

2 hours postweld tempering at

Wire grade	AW	426°C	482°C	538°C	593°C	649°C
LINCORE 102W	51	50	50	51	40	35
LINCORE 423L	43	42	46	38	33	32
LINCORE 423Cr	46	45	46	38	34	32

Hardness: HRC in 6 layers hardfacing application

PACKAGING AND AVAILABLE SIZES

Unit	Net weight (kg)
Bag	25
Sahara ReadyBag™ (SRB)	25
Metal drum	200

802: rev. C-EN23-01/02/16

CLASSIFICATION

Flux 839	ISO 14174:	S A FB 1 66 AC H5
Flux/Wire	AWS A5.17/A5.23	
839/L60	F6A2-EL12	
839/LNS135	F6A4-EM12	
839/L-61	F7A5-EM12K / F6P6-EM12K	
839/L-50M	F7A6-EH12K / F7P8-EH12K	
839/LNS140A	F7A4-EA2-A2	
839/LNS164	F9A0-EF3-F3 / F9P4EF3-F3	

GENERAL DESCRIPTION

Basic flux with excellent slag detachability

To be used in combination of mild steel or low alloy grades for multirun application

Suitable for single arc and tandem arc

Good resistance on primer coating

Also suitable with stainless 308L, 309L, 316L and 307

CHEMICAL COMPOSITION (W%), TYPICAL, ALL WELD METAL

Wire grade	C	Mn	Si	P	S	Mo	Ni
L-60	0.04	0.85	0.2	<0.01	<0.01		
LNS 135	0.05	1.2	0.2	<0.015	<0.01		
L-61	0.07	1.2	0.3	<0.015	<0.01		
L-50M	0.07	1.7	0.3	<0.015	<0.01		
LNS 140A	0.06	1.2	0.2	<0.015	<0.01	0.45	
LNS 164	0.07	1.7	0.3	<0.015	<0.01	0.45	0.80

MECHANICAL PROPERTIES, TYPICAL, ALL WELD METAL

Wire grade	Condition*	Yield strength (N/mm ²)	Tensile strength (N/mm ²)	Elongation (%)	Impact ISO-V(J)			
					-20°C	-40°C	-50°C	-60°C
L-60	AW	390	470	30	100			
LNS 135	AW	410	490		100	50		
L-61	AW	440	530	29	130	80		
	SR	400	510	31		115	65	
L-50M	AW	470	570	258		100		
	SR	415	520	29		140		110
LNS 140A	AW	460	560	26		80		
LNS 164	AW	650	710	20	50			
	SR	590	670	24	100	65		

AW : As welded - SR : Stress relieved

839: rev. C-EN03-18/06/15

All information in this data sheet is accurate to the best of our knowledge at the time of printing. Please refer to www.lincolnelectric.eu for any updated information.
Fumes: Safety Data Sheets (SDS) are available on our website.

EXAMPLES OF MATERIALS TO BE WELDED

Code	Type / Steel grades	Multirun							
		L-60	LNS 135	L-61	L-50M	LNS 133U	LNS 140A (L-70)	LNS 164 (L-84)	
		AW	AW	AW	AW	SR	AW	SR	AW
Ship plates									
	A to D	✓	✓	✓	✓		✓		
	AH[32],DH[36], DH[40]	✓			✓	✓	✓	✓	
General structural steels									
EN 10025 part 2	S185, S235, S275	✓	✓	✓	✓	✓			
	S355	✓	✓	✓	✓	✓	✓	✓	✓
Cast steels									
EN 10213-2	GP240R	✓	✓	✓	✓	✓			
Pipe materials									
EN 10208-2	L210, L240, L290	✓	✓	✓	✓	✓			
	L360	✓	✓	✓	✓	✓	✓	✓	
	L415				✓		✓	✓	
	L445, L480						✓	✓	
API 5LX	X42, X46	✓	✓	✓	✓	✓			
	X52	✓	✓	✓	✓	✓	✓	✓	
	X56, X60				✓		✓	✓	✓
	X65, X70						✓	✓	✓
EN 10216-1/10217-1	P235, P275	✓	✓	✓	✓	✓			
	P355	✓	✓	✓	✓	✓	✓	✓	✓
Boiler & pressure vessel steels									
EN 10028-1	P235GH, P265GH, P295GH	✓	✓	✓	✓	✓	✓	✓	
	P355GH	✓	✓	✓	✓	✓	✓	✓	✓
Fine grained steels									
EN 10025 part 3/part 4	S275	✓	✓	✓	✓	✓			
	S355	✓	✓	✓	✓	✓	✓	✓	✓
	S420				✓		✓	✓	✓
	S460							✓	✓
High yield strength steels									
EN 10025 part 6	S460, S500						✓	✓	

FLUX CHARACTERISTICS

Current type
Basicity (Boniszewski)
Solidification speed
Density (kg/dm³)
Grain size (ISO 14174)

DC/AC
2.4
Medium
1.2
2-20

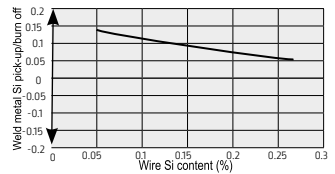
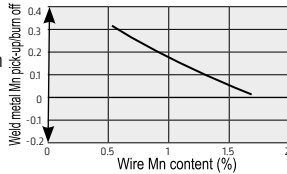

PACKAGING AND AVAILABLE SIZES

Unit Net weight (kg)

Bag 25

SAW

Lincolnweld® 842-H™

CLASSIFICATION

Flux	Flux/wire
ISO 14174 S A FB 155 AC H4	AWS A5.17 / A5.23
Lincolnweld® 842-H™ / L-61	F7A6/F6P8-EM12K-H4
Lincolnweld® 842-H™ / L-50M (LNS 133U)	F7A8/F7P8-EH12K-H4
Lincolnweld® 842-H™ / LNS 164 (LA 84)	F9A8/ F9P8-EF3-F3-H4
Lincolnweld® 842-H™ / LNS 165 (LA 85)	F8A8/ F8P8-ENi5-Ni5-H4
Lincolnweld® 842-H™ / LNS 140A	F8A4/ F7P4-EA2-A2-H4

GENERAL DESCRIPTION

Designed to meet the specific welding requirements of the offshore construction industry where consistency in operability, impact toughness, and diffusible hydrogen is critical.

Ultra-Low Diffusible Hydrogen – Less than 3 mL/100g of deposited weld metal in DC and AC polarities.

Consistent impact toughness capable of exceeding CVN values of 160 J at -60° C in the body and cap pass for consistent CTOD toughness.

Excellent AC and DC operation – High current capacity for single or multiple arc configurations.

High Operator Appeal – Excellent slag detachment and wash-out.

APPROVALS

Wire grade	ABS	DNV	LR	GL	TÜV	DB
L-50M (LNS 133U)	5YQM420 H5 (AC)	V YM42 H5 (AC)	5Y42M H5 (AC)	6Y42M H5 (AC)	✓	✓
LNS 164 (LA 84)	5YQM550 H5 (AC)	V YM55 H5 (AC)	5Y55M H5 (AC)	6Y55M H5 (AC)	✓	
LNS 165 (LA 85)	5YQM500 H5 (AC)	V YM50 H5 (AC)	5Y50M H5 (AC)	6Y50M H5 (AC)	✓	

CHEMICAL COMPOSITION (W%), TYPICAL, ALL WELD METAL

Wire grade	C	Mn	Si	P	S	Mo	Ni
L-61	0.09	1.0	0.20	<0.02	<0.015		
L-50M (LNS 133U)	0.10	1.5	0.30	<0.02	<0.015		
LNS 164 (LA 84)	0.10	1.6	0.25	<0.02	<0.015	0.5	0.8
LNS 165 (LA 85)	0.06	1.35	0.2	<0.02	<0.015	0.2	0.9
LNS 140A (L70)	0.06	0.9	0.2	<0.02	<0.015	0.4	

MECHANICAL PROPERTIES, TYPICAL, ALL WELD METAL

Wire grade	Condition	Yield strength (N/mm ²)	Tensile strength (N/mm ²)	Elongation (%)	Impact ISO-V(J)		
					-40°C	-51°C	-60°C
L-61	AW	430	520	33		300	
	SR	360	480	38			350
L-50M (LNS 133U)	AW	480	580	31			190
	SR	420	550	32			160
LNS 164 (LA 84)	AW	640	710	25			140
	SR	610	690	27			120
LNS 165 (LA 85)	AW	530	610	29			185
	SR	530	620	30			150
LNS 140A (L70)	AW	470	550	27	90		
	SR	440	530	30	80		

AW : As welded - SR : Stress relieved

Lincolnweld® 842-H™ rev. C-EN02-01/02/16

All information in this data sheet is accurate to the best of our knowledge at the time of printing. Please refer to www.lincolnelectric.eu for any updated information.
Fumes: Safety Data Sheets (SDS) are available on our website.

Lincolnweld® 842-H™

EXAMPLES OF MATERIALS TO BE WELDED

Code	Type / Steel grades	Multirun									
		L-61	L-50M (LNS 133U)	LNS 164 (LA 84)		LNS 165 (LA 85)		LNS 140A (L 70)			
		AW	AW	SR	AW	SR	AW	SR	AW	SR	
Ship plates											
	A to E	✓	✓	✓							
	AH[32], DH[36], EH[36]	✓	✓	✓	✓	✓	✓	✓	✓	✓	✓
General structural steels											
EN 10025 part 2	S185, S235, S275	✓	✓	✓							
	S355	✓	✓	✓	✓	✓	✓	✓	✓	✓	✓
Cast steels											
EN 10213-2	GP240R	✓	✓	✓							
Pipe materials											
EN 10208-2	L210, L240, L290	✓	✓	✓							
	L360	✓	✓	✓	✓	✓	✓	✓	✓	✓	✓
	L415		✓				✓	✓	✓	✓	✓
	L445, L480						✓	✓			
API 5LX	X42, X46	✓	✓	✓							
	X52	✓	✓	✓	✓	✓	✓	✓	✓	✓	✓
	X56, X60		✓		✓	✓	✓	✓	✓	✓	✓
	X65, X70				✓	✓	✓	✓			
EN 10216-1/10217-1	P235, P275	✓	✓	✓	✓	✓	✓	✓	✓	✓	✓
	P355	✓	✓	✓	✓	✓	✓	✓	✓	✓	✓
Fine grained steels											
EN 10025 part 3/part 4	S275	✓	✓	✓							
	S355	✓	✓	✓	✓	✓	✓	✓	✓	✓	✓
	S420		✓		✓	✓	✓	✓	✓	✓	✓
	S460				✓	✓	✓	✓	✓	✓	✓
	S500				✓	✓	✓	✓			

FLUX CHARACTERISTICS

Current type	DC/AC
Basicity (Boniszewski)	2.3
Solidification speed	Medium
Density (kg/dm³)	1.3
Grain size (ISO 14174)	2 - 20

SUGGESTIONS FOR USE

Suitable for deep groove	Single and multi-wire systems
Low temperatures requirements	Off-shore and on-shore applications
Highly restrained constructions	Nuclear components

PACKAGING AND AVAILABLE SIZES

Unit	Net weight (kg)
Plastic pail	22.7

8500

CLASSIFICATION

Flux	Flux/wire			
ISO 14174 S A FB 1 54 AC H5	8500 / L-61	AWS A5.17 / A5.23	ISO 14171-A : MR	ISO 14171-A : TR
	8500 / L-50M (LNS 133U)	F7A6/F6P8-EM12K	S 38 4 FB S2Si	S 4T 0 FB S2Si
	8500 / LNS 140A	F7A6/F7P8-EH12K	S 42 6 FB S3Si	S 4T 2 FB S3Si
	8500 / LNS 160	F8A6-EA2-A2	S 46 4 FB S2Mo	
	8500 / LNS 162	F7A8/P8-ENi1-Ni1	S 42 5 FB S2Ni1*	
	8500 / LNS 165 (LA85)	F7A8/P8-ENi2-Ni2	S 42 6 FB S2Ni2*	
	8500 / LNS T55	F8A8/F7P8-ENi5-Ni5	S 50 6 FB SZ	
			S 50 5 FB TZ	

* Nearest classification

GENERAL DESCRIPTION

Basic flux designed for carbon and low alloy steels

Excellent welding characteristics over a wide range of welding procedures

Superior mechanical properties

Impact properties are consistent throughout the weld joint, including the cap location

Excellent CTOD values

APPROVALS

Wire grade	BV	ABS	LRS	DNV	GL	RMRS
L-61					3YM/2YT	
L-50M (LNS 133U)	A3YT/A5YM	3YT/5YM	5Y40M/3Y40T	5Y40M/3Y40T		
LNS 140A (L-70)		3YM			3Y40M/4Y40T	3YM/4YT

CHEMICAL COMPOSITION (W%), TYPICAL, ALL WELD METAL

Wire grade	C	Mn	Si	P	S	Mo	Ni
L-61	0.08	1.0	0.2	<0.02	<0.015		
L-50M (LNS 133U)	0.07	1.4	0.3	<0.02	<0.015		
LNS 140A (L-70)	0.08	0.9	0.2	0.03	<0.025	0.4	
LNS 160	0.07	1.0	0.1	0.02	0.015		1.0
LNS 162	0.08	1.0	0.1	0.02	0.015		2.0
LNS 165 (LA 85)	0.07	1.3	0.2	0.02	0.015	0.2	0.9
LNS T55	0.08	1.7	0.7	<0.015	<0.015		

MECHANICAL PROPERTIES, TYPICAL, ALL WELD METAL

Wire grade	Condition*	Yield strength (N/mm ²)	Tensile strength (N/mm ²)	Elongation (%)	Impact ISO-V(J)		
					-20°C	-40°C	-60°C
L-61	MR	430	510	28	150	100	50
L-50M (LNS 133U)	MR	440	540	28		110	
	SR	>420	>500	30		150	
	MR	440	540	28		55	
LNS 140A (L-70)	MR	440	540	28		150	
	AW	430	510	30		150	50
LNS 160	SR	400	510	30		150	50
	AW	470	560			150	50
	SR	450	530			150	50
LNS 165 (LA 85)	AW	530	600	25		120	50
	SR	480	580	30		120	50
	AW	530	620		120	80	
LNS T55	SR	500	570			70	

* MR : Multirun - TR : Two-run - AW : As welded - SR : Stress relieved

8500: rev. C-EN24-01/02/16

All information in this data sheet is accurate to the best of our knowledge at the time of printing. Please refer to www.lincolnelectric.eu for any updated information.
Fumes: Safety Data Sheets (SDS) are available on our website.

8500

EXAMPLES OF MATERIALS TO BE WELDED

Code	Type / Steel grades	Multirun														
		L-61		L-50M (LNS 133U)			LNS 140A (L-70)		LNS 160		LNS 162		LNS 165		LNS T55	
		AW	AW	SR	AW	SR	AW	SR	AW	SR	AW	SR	AW	SR		
Ship plates																
	A to E	✓	✓	✓										✓	✓	
	AH(32),DH(36), EH(36)	✓	✓	✓	✓	✓	✓	✓	✓	✓	✓	✓	✓	✓	✓	
General structural steels																
EN 10025 part 2	S185, S235, S275	✓	✓	✓										✓	✓	
	S355	✓	✓	✓	✓	✓	✓	✓	✓	✓	✓	✓	✓	✓	✓	
Cast steels																
EN 10213-2	GP240R	✓	✓	✓										✓	✓	
Pipe materials																
EN 10208-2	L210, L240, L290	✓	✓	✓										✓	✓	
	L360	✓	✓	✓	✓	✓	✓	✓	✓	✓	✓	✓	✓	✓	✓	
	L415		✓		✓	✓						✓	✓	✓	✓	
	L445, L480											✓	✓			
API 5LX	X42, X46	✓	✓	✓												
	X52	✓	✓	✓	✓	✓	✓	✓	✓	✓	✓	✓	✓	✓	✓	
	X56, X60		✓		✓	✓						✓	✓	✓	✓	
	X65, X70											✓	✓			
EN 10216-1/10217-1	P235, P275	✓	✓	✓										✓	✓	
	P355	✓	✓	✓	✓	✓	✓	✓	✓	✓	✓	✓	✓	✓	✓	
Boiler & pressure vessel steels																
EN 10028-1	P235GH, P265GH, P295GH	✓	✓	✓	✓	✓										
Fine grained steels																
EN 10025 part 3/4	S275	✓	✓	✓										✓	✓	
	S355	✓	✓	✓	✓	✓	✓	✓	✓	✓	✓	✓	✓	✓	✓	
	S420		✓		✓	✓						✓	✓	✓	✓	
	S460											✓	✓			

FLUX CHARACTERISTICS

Current type	DC/AC
Basicity (Boniszewski)	2.8
Solidification speed	Medium
Density (kg/dm ³)	1.3
Grain size (ISO 14174)	2 - 20

SUGGESTIONS FOR USE

Suitable for deep groove	Single and multi-wire systems
Low temperatures requirements	Off-shore and on-shore applications
Highly restrained constructions	Nuclear components

PACKAGING AND AVAILABLE SIZES

Unit	Net weight (kg)
Bag	25
Sahara ReadyBag™ (SRB)	25
Metal drum	250

SAW

CLASSIFICATION

Flux	Flux/wire			
ISO 14174		AWS A5.17 / A5.23	ISO 14171-A : MR	ISO 14171-A : TR
S A AB 1 56 AC H5	860 / L-60	F6A2-EL12	S 35 2 AB S1	
	860 / LNS 135	F6A2-EM12	S 35 2 AB S2	S 3T 0 AB S2
	860 / L-61	F7A2-EM12K	S 38 2 AB S2Si	S 3T 0 AB S2Si
	860 / L-50M (LNS 133U)	F7A2/F7P2-EH12K	S 42 2 AB S3Si	
	860 / L-70	F7A2-EA1-A2	S 42 2 AB S2Mo	S 4T 2 AB S2Mo
	860 / LNS 140A	F7A2-EA2-A2	S 42 2 AB S2Mo	S 4T 2 AB S2Mo
	860 / LNS 163	F7A4-EG-G	S 42 4 AB S2Ni1Cu	
	860 / LNS T55	F7A2/F7P4-EC1	S 50 3 AB SZ	

GENERAL DESCRIPTION

Multi purpose neutral agglomerated flux

Good impact values in both multi-run (with L-60/L-61/L-50M) and two-run (with LNS 140A) techniques

High restraint cracking resistant

APPROVALS

Wire grade	BV	ABS	LRS	DNV	GL	RMRS	RINA	CRS	TÜV
L-60									✓
LNS 135					3M/3T				✓
L-61	A3YM/A2YT	YM/2YT	3YM/2YT	3YM/2YT	3YM/2YT	3YM/2YT	3M/3YM/2YT	3YM/2YT	✓
LNS 140A (L-70)	A3YTM		3Y40M/3YT	3Y40TM	3YM/2YT				✓
LNS 150									✓
LNS 163									✓

CHEMICAL COMPOSITION (W%), TYPICAL, ALL WELD METAL

Wire grade	C	Mn	Si	P	S	Mo
L-60	0.05	1.0	0.25	<0.025	<0.020	
LNS 135	0.06	1.3	0.3	<0.025	<0.020	
L-61	0.10	1.2	0.3	<0.025	<0.020	
L-50M (LNS 133U)	0.07	1.7	0.5	<0.025	<0.020	
LNS 140A (L-70)	0.05	1.3	0.3	<0.025	<0.020	0.4
LNS T55	0.06	1.8	0.7	<0.020	<0.015	

MECHANICAL PROPERTIES, TYPICAL, ALL WELD METAL

Wire grade	Condition*	Yield strength (N/mm ²)	Tensile strength (N/mm ²)	Elongation (%)	Impact ISO-V(J)	
					0°C	-20°C
L-60	AW	360	480	30	80	50
LNS 135	AW	390	490	33	100	50
L-61	AW	430	510	32	100	60
L-50M (LNS 133U)	SR	400	505	32		115
	AW	460	530	28	120	80
LNS 140A (L-70)	SR	420	520			115
	AW	520	570	26		70
LNS T55	SR	510	580	30		50
	AW	520	610			70
LNS 163	SR	470	560			70
	AW	460	540	27		55

* AW : As welded - SR : Stress relieved

860: rev. C-EN24-01/02/16

860

EXAMPLES OF MATERIALS TO BE WELDED

Code	Type / Steel grades	Multirun								
		L-60	LNS 135	L-61	L-50M (LNS 133U)	LNS 140A (L-70)	LNS T55			
		AW	AW	AW	AW	SR	AW	SR	AW	SR
Ship plates										
	A to D	✓	✓	✓	✓		✓			
	AH(32),DH(36), DH(40)	✓			✓	✓	✓	✓	✓	✓
General structural steels										
EN 10025 part 2	S185, S235, S275	✓	✓	✓	✓	✓				
	S355	✓	✓	✓	✓	✓	✓	✓	✓	✓
Cast steels										
EN 10213-2	GP240R	✓	✓	✓	✓	✓				
Pipe materials										
EN 10208-2	L210, L240, L290	✓	✓	✓	✓	✓				
	L360	✓	✓	✓	✓	✓	✓	✓	✓	✓
	L415				✓		✓	✓	✓	✓
	L445, L480						✓	✓		
API 5LX	X42, X46	✓	✓	✓	✓	✓				
	X52	✓	✓	✓	✓	✓	✓	✓	✓	✓
	X56, X60				✓		✓	✓	✓	✓
	X65, X70						✓	✓		
EN 10216-1/10217-1	P235, P275	✓	✓	✓	✓	✓				
	P355	✓	✓	✓	✓	✓	✓	✓	✓	✓
Boiler & pressure vessel steels										
EN 10028-1	P235GH, P265GH, P295GH	✓	✓	✓	✓	✓	✓	✓	✓	✓
	P355GH	✓	✓	✓	✓					
Fine grained steels										
EN 10025 part 3/4	S275	✓	✓	✓	✓	✓				
	S355	✓	✓	✓	✓	✓		✓	✓	✓
	S420				✓		✓	✓	✓	✓
	S460						✓			
High yield strength steels										
EN 10025 part 6	S460, S500						✓			

FLUX CHARACTERISTICS

Current type	DC/AC
Basicity (Boniszewski)	1.1
Solidification speed	High
Density (kg/dm ³)	1.4
Grain size (ISO 14174)	1 - 16

PACKAGING AND AVAILABLE SIZES

Unit	Net weight (kg)
Bag	25
Sahara ReadyBag™ (SRB)	25
Big Bag	1000

CLASSIFICATION

Flux	Flux/wire		
ISO 14174		AWS A5.17 / A5.23	ISO 14171-A : MR
S A FB 1 66 AC H5	888 / L-61	F7A6-EM12K	S 38 5 FB S2Si
	888 / L-50M (LNS 133U)	F7A8/F6P8-EH12K	S 42 6 FB S3Si
	888 / LNS 140A	F8A4-EA2-A2	S 46 4 FB S2Mo
	888 / L-70	F8A4-EA1-A2	S 46 4 FB S2Mo
	888 / LNS 160	F7A8/P8-ENi1-Ni1	S 42 5 FB S2Ni1*
	888 / LNS 162	F7A8/F7P8-ENi2-Ni2	S 42 6 FB S2Ni2*
	888 / LNS 164	F9A6/F9P4-EF3-F3	S 50 4 FB S3Ni1Mo
	888 / LNS 165	F8A6/F7P8-ENi5-Ni5	S 50 4 FB Sz
	888 / LNS 150	F7P6-EB2-B2	S 50 2 FB CrMo1
	888 / LNS 151	F8P6-EB3-B3	
	888 / LA-100	F10A4-EM2-M2	S 50 4 FB SZ

GENERAL DESCRIPTION

Basic flux designed for carbon and low alloy steels
 Easy slag removal in deep groove
 Robust mechanical properties including CTOD values
 Bruscato factor typically below 12 ppm with LNS150 & LNS151 wires
 Excellent in multi arc configurations
 Only available in Sahara ReadyBag™

APPROVALS

Wire grade	TÜV
L-61	✓

CHEMICAL COMPOSITION (W%), TYPICAL, ALL WELD METAL

Wire grade	C	Mn	Si	P	S	Ni	Mo	Cr	Bruscato factor
L-61	0.08	1.05	0.37	<0.02	<0.015				
L-50M (LNS 133U)	0.07	1.45	0.55	<0.02	<0.015				
LNS 140A (L-70)	0.07	1.0	0.35	<0.02	<0.015		0.4		
LNS 160	0.07	1.2	0.4	<0.02	<0.015	0.95			
LNS 162	0.07	1.1	0.4	<0.02	<0.015	2.1			
LNS 164	0.08	1.7	0.5	<0.02	<0.01	0.9	0.5		
LNS 165	0.06	1.50	0.5	<0.02	<0.015	0.97	0.2		
LNS 150	0.069	0.90	0.5	<0.02	<0.015		0.56	1.34	<10 ppm
LNS 151	0.062	0.85	0.3	<0.02	<0.015		0.93	2.15	<10 ppm
LA-100	0.06	1.60	0.7	<0.02	<0.015	1.8	0.42	0.08	

MECHANICAL PROPERTIES, TYPICAL, ALL WELD METAL

Wire grade	Condition*	Yield strength (N/mm ²)	Tensile strength (N/mm ²)	Elongation (%)	Impact ISO-V(J)			
					-20°C	-40°C	-50°C	-60°C
L-61	AW	415	515	31		135	100	
L-50M (LNS 133U)	AW	480	580	29			90	70
	SR	430	550	31		105		65
LNS 160	AW	470	550	26		115		
	SR	410	510	27		160		120
LNS 162	AW	500	580	25		100		55
	SR	440	550	25		160		120
LNS 164	AW	650	750	21		65		30
	SR	610	700	23		65		30
LNS 165	AW	530	620	26		70		40
	SR	495	595	27				70
LNS 150	SR	420	580	26	100			
LNS 151	SR	530	645	23				
LA-100	AW	680	760	25				

* AW : As welded - SR : Stress relieved

All information in this data sheet is accurate to the best of our knowledge at the time of printing. Please refer to www.lincolnelectric.eu for any updated information.
 Fumes: Safety Data Sheets (SDS) are available on our website.

888: rev. C-EN26-01/02/16

EXAMPLES OF MATERIALS TO BE WELDED

Steel grades/Code	Type	Multirun													
		L-61	L-50M (LNS 133U)	L-70	LNS 164	LNS 165	LNS 150	LNS 151	LNS 160	LNS 162	LA 100				
		AW -50°C	AW -60°C	SR-60°C	AW	AW-40°C	AW-40°C	SR-60°C	SR-50°C	SR-50°C	AW	SR	AW	SR	AW-40°C
Ship plates															
	A to E	✓	✓	✓											
	AH(32),DH(36),EH(36)	✓	✓	✓	✓	✓	✓				✓	✓	✓	✓	
General structural steels															
EN 10025 part 2	S185, S235, S275	✓	✓	✓											
	S355	✓	✓	✓	✓	✓	✓				✓	✓	✓	✓	
Cast steels															
EN 10213-2	GP240R	✓	✓	✓											
Pipe materials															
EN 10208-2	L210, L240, L290	✓	✓	✓											
	L360	✓	✓	✓	✓	✓	✓				✓	✓	✓	✓	
	L415		✓		✓	✓	✓								
	L445, L480				✓	✓	✓								
EN 10216-1/10217-1	P235, P275	✓	✓	✓											
	P355	✓	✓	✓	✓	✓	✓				✓	✓	✓	✓	
Boiler & pressure vessel steels															
EN 10028-1	P235GH, P265GH, 295GH	✓	✓	✓											
EN 10028-2 (High temperature steel)	16 Mo 3				✓										
	13CrMo 4-5								✓	✓					
	10CrMo 9-10								✓	✓					
EN 10028-4/10222-3 (Low temperature steel)	11MnNi5-3, 13MnNi6-3					✓	✓				✓	✓	✓	✓	✓
Fine grained steels															
EN 10025 part 3/4	S275	✓	✓	✓											
	S355	✓	✓	✓	✓	✓	✓				✓	✓	✓	✓	
	S420		✓		✓	✓	✓						✓	✓	
	S460				✓	✓	✓								
High yield strength steels															
EN 10025 part 6	S460, S500				✓	✓	✓				✓	✓	✓	✓	

FLUX CHARACTERISTICS

Current type	AC / DC
Basicity (Boniszewski)	2.3
Solidification speed	High
Grain size (ISO 14174)	2 - 20

SUGGESTIONS FOR USE

Boiler and pressure vessels
Off-shore applications
Wind towers
Structural fabrications

PACKAGING AND AVAILABLE SIZES

Unit	Net weight (kg)
Sahara ReadyBag™ (SRB)	25

960

CLASSIFICATION

Flux	Flux/wire			
ISO 14174 S A AB 1 66 AC H5	960 / L-61	AWS A5.17 / A5.23	ISO 14171-A : MR	ISO 14171-A : TR
	960 / L-50M (LNS133 U)	F7A2-EM12K	S 38 2 AB S2Si	S 3T 2 AB S2Si
	960 / LNS 163	F7A2-EH12K	S 38 2 AB S3Si	S 3T 2 AB S3Si
		F7A4-EG-G	S 42 4 AB S2NiCu	

GENERAL DESCRIPTION

General purpose neutral flux
 Attractive as the "one-flux" in the shop
 Very good results in semi-automatic submerged arc welding
 Very good operating characteristics (deslagging - wash in - aspect)

CHEMICAL COMPOSITION (W%), TYPICAL, ALL WELD METAL

Wire grade	C	Mn	Si	P	S
L-61	0.07	1.3	0.4	<0.03	<0.025
L-50M(LNS 133U)	0.07	1.6	0.6	<0.03	<0.025

MECHANICAL PROPERTIES, TYPICAL, ALL WELD METAL

Wire grade	Condition*	Yield strength (N/mm ²)	Tensile strength (N/mm ²)	Elongation (%)	Impact ISO-V(J)	
					-20°C	-40°C
L-61	AW	420	510	28	50	
L-50M(LNS 133U)	AW	430	530	28	70	
LNS 163	AW	460	540	27		55

* AW : As welded

960: rev. C-EN24-01/02/16

960

EXAMPLES OF MATERIALS TO BE WELDED

Code	Type / Steel grades	Multirun		Two-run	
		L-61	L-50M (LNS 133U)	L-61	L-50M (LNS 133U)
Ship plates					
	A to E	✓	✓	✓	✓
	AH(32),DH(36), EH(36)	✓	✓	✓	✓
General structural steels					
EN 10025 part 2	S185, S235, S275	✓	✓	✓	✓
	S355	✓	✓	✓	✓
Cast steels					
EN 10213-2	GP240R	✓	✓	✓	✓
Pipe materials					
EN 10208-2	L210, L240, L290	✓	✓	✓	✓
	L360	✓	✓	✓	✓
	L415		✓		✓
API 5LX	X42, X46	✓	✓	✓	✓
	X52	✓	✓	✓	✓
	X56, X60		✓		✓
EN 10216-1/10217-1	P235, P275	✓	✓	✓	✓
	P355	✓	✓	✓	✓
Boiler & pressure vessel steels					
EN 10028-1	P235GH, P265GH, P295GH	✓	✓	✓	✓
	P355GH	✓	✓	✓	✓
Fine grained steels					
EN 10025 part 3/4	S275	✓	✓	✓	✓
	S355	✓	✓	✓	✓
	S420		✓		✓

FLUX CHARACTERISTICS

Current type	DC / AC
Basicity (Boniszewski)	1.0
Solidification speed	high
Density (kg/dm ³)	1.4
Grain size (ISO 14174)	1 -16

SUGGESTIONS FOR USE

Wire	Characteristics
L-61	General purpose
L-50M(LNS 133U)	For dirty plates

Applications

Butt welds (single pass and multi-run)
Fillet welds

PACKAGING AND AVAILABLE SIZES

Unit	Net weight (kg)
Bag	25
Sahara ReadyBag™ (SRB)	25

980

CLASSIFICATION

Flux	Flux/wire			
ISO 14174		AWS A5.17 / A5.23	ISO 14171-A : MR	ISO 14171-A : TR
S A AR/AB 1 57 AC H5	980 / L-61	F7A2-EM12K	S 38 2 AR/AB S2Si	S 3T 2 AR/AB S2Si
	980 / L-50M (LNS 133U)	F7A2-EH12K	S 38 2 AR/AB S3Si	S 4T 2 AR/AB S3Si

GENERAL DESCRIPTION

Outstanding slag removal, also in narrow grooves
 Multi purpose flux
 Suitable for semi-automatic submerged arc welding
 Attractive as the "one-flux" in the shop

CHEMICAL COMPOSITION (W%), TYPICAL, ALL WELD METAL

Wire grade	C	Mn	Si	P	S
L-61	0.06	1.5	0.3	<0.02	<0.02
L-50M(LNS 133U)	0.07	1.7	0.4	<0.02	<0.02

MECHANICAL PROPERTIES, TYPICAL, ALL WELD METAL

Wire grade	Condition*	Yield strength (N/mm ²)	Tensile strength (N/mm ²)	Elongation (%)	Impact ISO-V(J)
					-20°C
L-61	MR	420	520	29	50
L-50M(LNS 133U)	MR	460	550	29	60

* MR : Multirun

980: rev. C-EN25-01/02/16

All information in this data sheet is accurate to the best of our knowledge at the time of printing. Please refer to www.lincolnelectric.eu for any updated information.
 Fumes: Safety Data Sheets (SDS) are available on our website.

980

EXAMPLES OF MATERIALS TO BE WELDED

Code	Type / Steel grades	Multirun	
		L-61	L-50M (LNS 133U)
Ship plates			
	A to E	✓	✓
	AH(32),DH(36), EH(36)	✓	✓
General structural steels			
EN 10025 part 2	S185, S235, S275	✓	✓
	S355	✓	✓
Cast steels			
EN 10213-2	GP240R	✓	✓
Pipe materials			
EN 10208-2	L210, L240, L290	✓	✓
	L360	✓	✓
	L415		✓
API 5LX	X42, X46	✓	✓
	X52	✓	✓
	X56, X60		✓
EN 10216-1/10217-1	P235, P275	✓	✓
	P355	✓	✓
Boiler & pressure vessel steels			
EN 10028-1	P235GH, P265GH, P295GH	✓	✓
	P355GH	✓	✓
Fine grained steels			
EN 10025 part 3/part 4	S275	✓	✓
	S355	✓	✓
	S420		✓

FLUX CHARACTERISTICS

Current type	DC / AC
Basicity (Boniszewski)	0.6
Solidification speed	high
Density (kg/dm ³)	1.4
Grain size (ISO 14174)	1 -16

SUGGESTIONS FOR USE

Wire	Applications
L-61	Lower cost combination
L-50M(LNS 133U)	For the best operating characteristics For the best impact values in multi-pass

PACKAGING AND AVAILABLE SIZES

Unit	Net weight (kg)
Bag	25

995N

CLASSIFICATION

Flux	Flux/wire		
ISO 14174 S A AB 1 67 AC H5	995N / LNS 140A	AWS A5.23	ISO 14171-A : TR
	995N / LNS 140TB (LA-81)	F9TA6-G-EA2TiB	S 4T 2 AB S2Mo
	995N / LNS 133TB	F9TA6-G-EG	S 5T 5 AB S2MoTiB

GENERAL DESCRIPTION

Neutral agglomerated flux designed for longitudinal multi-arc welding pipe mill station
 High end pipe mill applications up to X80
 Outstanding welding characteristics and bead profile
 Better results on pipe thickness over 12mm
 Nitrogen controlled weld metal providing good impact toughness on arctic grade pipes
 Very low diffusible hydrogen level in the weld deposit

CHEMICAL COMPOSITION (W%), TYPICAL, ALL WELD METAL

Base material	Wire grade	C	Mn	Si	P	S	Mo	Ti	B	N
X65	LNS 140A (L-70)	0.07	1.45	0.3	<0.025	<0.025	0.2	-	-	0.005
X80	LNS 140TB (LA-81)	0.06	1.6	0.35	<0.025	<0.025	0.2	0.015	0.002	0.004

Remark: the chemical composition from butt welds in pipe depends on the chemical composition of base material.
 Proced : tandem AC/AC application on X65 plate 12,7 mm thick.

MECHANICAL PROPERTIES, TYPICAL, ALL WELD METAL

Wire grade	Condition*	Yield strength (N/mm ²)	Tensile strength (N/mm ²)	Elongation (%)	Impact ISO-V(J)				Hardness
					-20°C	-40°C	-50°C	-60°C	
Procedure 1									
LNS 140A (L-70)	TR	580	680	30	95	65			230
LNS 140TB (LA-81)	TR	630	700	27	115	75	50		235
Procedure 2									
LNS 140TB (LA-81)	TR	600	720	25	100	65		45	220-235
Procedure 3									
LNS 133TB	TR	600	700	27		120		90	

Remark: the mechanical properties from butt welds in pipe depends on the chemical composition of base material.
 Procedure 1: tandem in 12,5mm X65; Procedure 2: multiwire weld (4/5 wires) in 19-25mm X65 ; Procedure 3 : AWS
 test plate

* TR : Two-run

995N: rev. C-EN25-15/07/15

995N

EXAMPLES OF MATERIALS TO BE WELDED

Code	Type / Steel grades	Two-run		
		LNS 140TB (LA-81)	LNS 140A (L-70)	LNS 133TB
Ship plates				
	A to E	✓	✓	✓
	A 32 to FH40	✓	✓	✓
General structural steels				
EN 10137	500 to 550 A & AL	✓	✓	✓
EN 10025 part 3/4	S275 to S460 all qualities	✓	✓	✓
EN 10149	S315 to S650 all qualities	✓	✓	✓
EN 10025 part 2	S185 to S355 all qualities	✓	✓	✓
	E295 to E360	✓	✓	✓
Boiler & pressure vessel steels				
EN 10028	P235 to P460G all qualities	✓	✓	✓
	P235 to P275		✓	✓
	A37 to A52 all qualities	✓	✓	✓
	PF24 to PF36 all qualities	✓	✓	✓
	P265 to P460 all qualities	✓	✓	✓
	A37 to A52, CP	✓	✓	✓
	X42 to X70	✓	✓	✓
	X42 to X80	✓		✓

FLUX CHARACTERISTICS

Current type	DC / AC
Basicity (Boniszewski)	1.3
Solidification speed	Medium
Density (kg/dm ³)	1.0
Grain size (ISO 14174)	2 -20

SUGGESTIONS FOR USE

One run on each side in one or multi wire systems for high welding speed and excellent mechanical properties.

PACKAGING AND AVAILABLE SIZES

Unit	Net weight (kg)
Bag	25
Sahara ReadyBag™ (SRB)	25
Big Bag	500 / 600 / 1000

998N / 998N-P

CLASSIFICATION

Flux	Flux/wire		
ISO 14174 S A AB 1 67 AC H5	998N / LNS 140A	AWS A5.23	ISO 14171-A : TR
	998N / LNS140TB (LA-81)	F9TA6-G-EA2TiB	S 4T 2 AB S2Mo
	998N / LNS133TB	F9TA6-G-EG	S 5T 5 AB S2MoTiB

GENERAL DESCRIPTION

Flux designed for longitudinal multi-arc welding pipe mill station also suitable for spiral welds

High end pipe mill applications up to X80

Superior resistance to undercuts on thin metal sheet work at high speed

Designed to operate on all the range of pipe thickness (6 to 50 mm)

Nitrogen controlled weld metal providing good impact toughness on arctic grade pipes

Superior resistance to surface defects

Very low diffusible hydrogen level in the weld deposit

998N-P is a coarser size distribution of 998N for flux consumption reduction

CHEMICAL COMPOSITION (W%), TYPICAL, ALL WELD METAL

Base material	Wire grade	C	Mn	Si	P	S	Mo	Ti	B	N
X65	LNS 140TB (LA-81)	0.067/0.076	1.41/1.51	0.28/0.34	0.017/0.020	0.003/0.004	0.22/0.27	0.024/0.034	0.0028/0.0036	0.005/0.01
X80	LNS 140TB (LA-81)	0.045/0.06	1.6/1.64	0.35/0.4	0.016/0.017	0.004/0.005	0.3/0.35	0.031/0.034	0.0029/0.0032	0.005/0.006

Remark: the chemical composition from butt welds in pipe depends on the chemical composition of base material.

Proced1: triple arc application on X65 plate 15,9 mm thick; Proced2: tandem applications on X80 plate 12,7mm thick.

MECHANICAL PROPERTIES, TYPICAL, ALL WELD METAL

Wire grade	Condition*	Yield strength (N/mm ²)	Tensile strength (N/mm ²)	Elongation (%)	Impact ISO-V(J)				Hardness
					-20°C	-40°C	-50°C	-60°C	
Procedure 1									
LNS 140A (L-70)	AW	570	680	27					230
LNS 140TB (LA-81)	AW	610	700	27	115	75	50		235
Procedure 2									
LNS 140TB (LA-81)	AW	640	730	24	160	120	90	70	220-235
Procedure 3									
LNS 133TB	TR	610	730	26			120	80	

Remark: the mechanical properties from butt welds in pipe depends on the chemical composition of base material.

Procedure 1: tandem in 12,5mm X65; Procedure 2: multiwire weld (4/5 wires) in 19-25mm X65 ; Procedure 3 : AWS test plate

* AW : As welded

998N: rev. C-EN24-01/02/16

998N / 998N-P

EXAMPLES OF MATERIALS TO BE WELDED

Code	Type / Steel grades	Two-run		
		LNS 140TB (LA-81)	LNS 140A (L-70)	LNS 133TB
Ship plates				
	A to E	✓	✓	✓
	A 32 to FH40	✓	✓	✓
General structural steels				
EN 10137	500 to 550 A & AL	✓	✓	✓
EN 10025 part 3/4	S275 to S460 all qualities	✓	✓	✓
EN 10149	S315 to S650 all qualities	✓	✓	✓
EN 10025 part 2	S185 to S355 all qualities	✓	✓	✓
	E295 to E360	✓	✓	✓
Boiler & pressure vessel steels				
EN 10028	P235 to P460G all qualities	✓	✓	✓
	P235 to P275	✓	✓	✓
	A37 to A52 all qualities	✓	✓	✓
	PF24 to PF36 all qualities	✓	✓	✓
	P265 to P460 all qualities	✓	✓	✓
	A37 to A52, CP	✓	✓	✓
	X42 to X70	✓	✓	✓
	X42 to X80	✓	✓	✓

FLUX CHARACTERISTICS

Current type	DC / AC
Basicity (Boniszewski)	1.3
Solidification speed	fast
Density (kg/dm ³)	1.3
Grain size (ISO 14174)	2 -20

PACKAGING AND AVAILABLE SIZES

Unit	Net weight (kg)
Bag	25
Sahara ReadyBag™ (SRB)	25
Metal drum	200
Big Bag	500 / 600 / 1000

P223

CLASSIFICATION

Flux	Flux/wire		
ISO 14174		AWS A5.17 / A5.23	ISO 14171-A : TR
S A AB 1 67 AC H5	P223 / L-61	F7A4-EM12K	S 4T 2 AB S2Si
	P223 / L-50M [LNS 133U]	F7A5-EH12K	S 4T 2 AB S3Si
	P223 / LNS 140A	F8A4-EA2-A2	S 4T 4 AB S2Mo
	P223 / LNS 133TB	F8TA4-G-EG	

GENERAL DESCRIPTION

Aluminate basic agglomerated flux

Good impact values in two-run and multi-run technique

Low hydrogen content

Very suitable for longitudinal and spiral pipe welding

Usable up to 3 wire systems

Fine grain version available for the thinnest wall and fastest welding speed

CHEMICAL COMPOSITION (W%), TYPICAL, ALL WELD METAL

Wire grade	C	Mn	Si	P	S	Mo	Ni
L-61	0.08	1.4	0.2	<0.02	<0.015		
L-50M [LNS 133U]	0.07	1.7	0.3	<0.02	<0.015		
LNS 140A [L-70]	0.08	1.4	0.2	0.03	<0.025	0.4	
LNS 160	0.07	1.3	0.25	0.02	0.015		1.0
LNS 162	0.08	1.3	0.25	0.02	0.015		2.0
LNS 165 [LA-85]	0.07	1.5	0.3	0.02	0.015	0.2	0.9
LNS T55	0.08	1.7	0.7	<0.015	<0.015		

Remark: the chemical composition from butt welds in pipe depends on the chemical composition of base material.

MECHANICAL PROPERTIES, TYPICAL, ALL WELD METAL

Wire grade	Condition*	Yield strength [N/mm ²]	Tensile strength [N/mm ²]	Impact ISO-V(J)	
				-20°C	-40°C
L-61	TR	450	550	60	
L-50M [LNS 133U]	TR	470	570	80	
LNS 140A [L-70]	TR	500	600		50
LNS 133TB	TR	510	610		60

* TR : Two-run

P223: rev. C-EN23-11/05/16

P223

EXAMPLES OF MATERIALS TO BE WELDED

Code	Type / Steel grades	Two-run	
		LNS 140A (L-70)	LNS 133TB
General structural steels			
EN 10025 part 6	500A	✓	✓
EN 10025 part 3/part 4	S275 to 460 N, NL	✓	✓
EN 10149	S315 to S500MC & NC	✓	✓
EN 10025 part 2	S185, S235, S275, S355	✓	✓
Pipe material			
API 5LX	X 42 to X70	✓	✓
Boiler & pressure vessel steels			
EN 10028-1	P235 to P460 all qualities	✓	✓
EN 10207	P235 to P275 S & SL	✓	✓
A36-601 & NF A36-605	A37 to A52 CP, AP & F	✓	✓
EN 10222	P285 & P420 all qualities	✓	✓
Offshore plates			
A36-212	PF 24 to PF 36 all qualities	✓	✓

FLUX CHARACTERISTICS

Current type	DC / AC
Basicity (Boniszewski)	1.6
Solidification speed	High
Density (kg/dm ³)	1.2
Grain size (ISO 14174)	2 -20

SUGGESTIONS FOR USE

Single/ multi wire welding
Longitudinal and spiral pipe welding.

PACKAGING AND AVAILABLE SIZES

Unit	Net weight (kg)
Bag	25
Sahara ReadyBag™ (SRB)	25
Big Bag	500
Big Bag	600
Big Bag	100

P230

CLASSIFICATION

Flux	Flux/wire			
ISO 14174		AWS A5.17 / A5.23	ISO 14171-A : MR	ISO 14171-A : TR
S A AB 1 67 AC H5	P230 / LNS 135	F7A4/F7P6-EM12	S 38 4 AB S2	S 4T 2 AB S2
	P230 / L-61	F7A4/F6P5-EM12K	S 38 4 AB S2Si	
	P230 / L-50M (LNS 133U)	F7A5/F7P5-EH12K	S 46 5 AB S3Si	
	P230 / LNS 140A	F8A4-EA2-G	S 46 4 AB S2Mo	S 4T 4 AB S2Mo
	P230 / L-70	F8A4-EA1-G	S 46 4 AB S2Mo	S 4T 4 AB S2Mo
	P230 / LNS 160	F7A8/F7P8-ENi1-Ni1	S 46 4 AB S2Ni1*	
	P230 / LNS 162	F7A8/F7P8-ENi2-Ni2	S 46 6 AB S2Ni2*	
	P230 / LNS T55	F7A4/F7P5-EC1	S50 4 AB Tz	

GENERAL DESCRIPTION

Aluminate basic agglomerated flux
Low hydrogen content

One flux to combine with a wide range of wire electrodes

Good impact values in two-run and multi-run technique

Selection of wires provides application possibilities from -40 to +400°C

APPROVALS

Wire grade	BV	ABS	LRS	DNV	GL	RMRS	RINA	TÜV
L-61		4YTM	4YTM				4YTM	X
L-50M (LNS 133U)	A4YM/A3YT		4Y40M/3Y40T	4YM				X
LNS 140A (L-70)	A4YTM	4YTM/2YT	4YM		4Y40TM	3YTM	4YTM	X
LNS 135								X
LNS 160								X
LNS 162								X
LNS T55								X

CHEMICAL COMPOSITION (W%), TYPICAL, ALL WELD METAL

Wire grade	C	Mn	Si	P	S	Mo	Ni
L-61	0.06	1.4	0.4	<0.03	<0.02		
LNS 135	0.07	1.4	0.25	<0.03	<0.02		
L-50M (LNS 133U)	0.08	1.8	0.5	<0.03	<0.02		
LNS 140A (L-70)	0.07	1.4	0.3	<0.03	<0.02	0.5	
LNS 160	0.07	1.4	0.3	<0.03	<0.02		1.1
LNS 162	0.08	1.2	0.3	<0.03	<0.02		2.1
LNS T55	0.07	1.8	0.8	0.02	0.015		

MECHANICAL PROPERTIES, TYPICAL, ALL WELD METAL

Wire grade	Condition*	Yield strength (N/mm ²)	Tensile strength (N/mm ²)	Elongation (%)	Impact ISO-V(J)		
					-20°C	-40°C	-60°C
LNS 135	AW	400	500	30	50		
L-61	AW	450	520	30	100		
	SR	400	490	30	140	80	
L-50M (LNS 133U)	AW	480	580	30		80	
	SR	460	540	28		70	
LNS 140A (L-70)	MR	540	620	28	70		
	TR		620			60	
LNS 160	AW	490	570	28		120	45
	SR	430	550	28		140	75
LNS 162	AW	500	590	28		120	50
	SR	460	570	28		150	80
LNS T55	AW	540	630	28	90	60	
	SR	520	610	28	80	50	

* MR : Multirun - TR : Two-run - AW : As welded - SR : Stress relieved

P230-1; rev. C-EN25-11/05/16

All information in this data sheet is accurate to the best of our knowledge at the time of printing. Please refer to www.lincolnelectric.eu for any updated information.
 Fumes: Safety Data Sheets (SDS) are available on our website.

P230

EXAMPLES OF MATERIALS TO BE WELDED

Code	Type / Steel grades	Multi-run			
		LNS 135	L-61	L-50M [LNS 133U]	LNS 140A [L-70]
Ship plates					
	A to D	✓	✓	✓	✓
	AH[32],DH[40]	✓	✓	✓	✓
General structural steels					
EN 10025 part 6	500A				✓
EN 10025 part 3/part 4	S275 to 460 N, NL	✓	✓	✓	✓
	S275 to 420 N, NL, M & ML		✓	✓	✓
	S275 to 460 N, NL, M & ML			✓	✓
EN 10149	S315 & S355 MC & NC	✓	✓	✓	✓
	S315 to S420MC & NC		✓	✓	✓
	S315 to S460MC & NC			✓	✓
	S315 to S500MC & NC				✓
Boiler & pressure vessel steels					
EN 10028-2	P295GH, P355GH, 16Mo3	✓	✓		
EN 10022-2	17Mo3, 14Mo6	✓	✓		

FLUX CHARACTERISTICS

Current type	DC (+-)/AC
Basicity [Boniszewski]	1.6
Solidification speed	High
Density (kg/dm ³)	1.2
Grain size [ISO 14174]	2 -20

SUGGESTIONS FOR USE

- Excellent multi application flux on the shop floor
- Excellent welding behaviour in single arc and tandem application
- Very good mechanical properties at low temperature in either two-run or multi run technique.

PACKAGING AND AVAILABLE SIZES

Unit	Net weight (kg)
Bag	25
Sahara ReadyBag™ (SRB)	25

P230

CLASSIFICATION

Flux	Flux/wire			
ISO 14174	AWS A5.17 / A5.23	ISO 14171-A / ISO 26304	ISO 21952-A	
S A AB 1 67 AC H5	P230 / LNS 150	F8P2-EB2-B2R	S CrMo1	
	P230 / LNS 151	F9PZ-EB3-B3R	S CrMo2	
	P230 / LNS 163		S 38 4 AB S2 NiCu	
	P230 / LNS 164	F9A6-EF1*-F3	S 50 4 AB S3NiMo1	
	P230 / LNS 168		S 69 4 AB S3Ni2.5CrMo	

GENERAL DESCRIPTION

Aluminate basic agglomerated flux

Low hydrogen content

One flux to combine with a wide range of wire electrodes

Good impact values in two-run and multi-run technique

Selection of wires provides application possibilities from -40 to +400°C

APPROVALS

Wire grade	TÜV
LNS 164	✓

CHEMICAL COMPOSITION (W%), TYPICAL, ALL WELD METAL

Wire grade	C	Mn	Si	P	S	Mo	Ni	Cr	Cu
LNS 150	0.08	1.1	0.3	<0.02	<0.01	0.5		0.9	
LNS 151	0.12	0.8	0.3	<0.02	<0.01	1.0		2.6	
LNS 163	0.07	1.1	0.6	<0.02	0.02		0.7		0.7
LNS 164	0.07	1.5	0.3	<0.02	<0.01	0.5	1.0		
LNS 168	0.09	1.7	0.4	<0.02	<0.02	0.4	2.4	0.25	

MECHANICAL PROPERTIES, TYPICAL, ALL WELD METAL

Wire grade	Condition*	Yield strength (N/mm ²)	Tensile strength (N/mm ²)	Elongation (%)	Impact ISO-V(J)		
					0°C	-20°C	-40°C
LNS 150	SR	535	620	25	70	90**	60**
LNS 151	SR	560	640	24		30	
LNS 163	AW	450	600	20	60	70	
LNS 164	AW	630	710	22	90	80	50
	SR	630	710	24	70	60	35
LNS 168	AW	710	840	20		65	min. 47

* SR : Stress relieved - AW : As welded - **SR = 2h/720°C

P230-2: rev. C-EN25-11/05/16

All information in this data sheet is accurate to the best of our knowledge at the time of printing. Please refer to www.lincolnelectric.eu for any updated information.
Fumes: Safety Data Sheets (SDS) are available on our website.

P230

EXAMPLES OF MATERIALS TO BE WELDED

Code	Type / Steel grades				
		LNS 150	LNS 151	LNS 164	LNS 168
Pipe materials					
EN 10208-2	L415			✓	
	L445, L480			✓	
API 5LX	X56, X60			✓	
	X65, X70			✓	
Gaz de France	X63			✓	
Boiler & pressure vessel steels					
EN 10028-2	13CrMo 4-5	✓	✓		
High temperature steel	10CrMo 9-10	✓	✓		
EN 10028-4/10222-3	13MnNi6-3				
Low temperature steel	11MnNi5-3				
Fine grained steels					
EN 10025 part 3/part 4	S420			✓	
EN 10025 part 6	S460			✓	
High yield strength steels					
EN 10025 part 6	S460, S690				✓

FLUX CHARACTERISTICS

Current type	DC / AC
Basicity (Boniszewski)	1.6
Solidification speed	High
Density (kg/dm ³)	1.2
Grain size (ISO 14174)	2 -20

SUGGESTIONS FOR USE

- Excellent multi application flux on the shop floor
- Excellent welding behaviour in single arc and tandem application
- Very good mechanical properties at low temperature in either two-run or multi run technique.

PACKAGING AND AVAILABLE SIZES

Unit	Net weight (kg)
Bag	25
Sahara ReadyBag™ (SRB)	25

P240

CLASSIFICATION

Flux	Flux/wire		
ISO 14174		AWS A5.17 / A5.23	ISO 14171-A : MR
S A FB 1 55 AC H5	P240 / L-61 (LNS129)	F7A6-EM12K	S 42 4 FB S2Si
	P240 / L-50M (LNS133U)	F7A8/P8-EH12K	S 42 6 FB S3Si
	P240 / LNS 160	F7A10/P10-ENi1-Ni1	S 46 6 FB S2Ni1*
	P240 / LNS 162	F7A10/P10-ENi2-Ni2	S 46 6 FB S2Ni2*
	P240 / LNS 165 (LA-85)	F8A8/P8-ENi5-Ni5	S 50 6 FB Sz
	P240 / LNS 150 (LA-92)	F8P2-EB2-B2R	
	P240 / LNS 151 (LA-93)	F9P0-EB3-B3R	
	P240 / LNS 168	F10A5-EM2-M2	S 69 4 FB S3NiCr2.5Mo

GENERAL DESCRIPTION

Highly basic fluoride agglomerated flux
 Good impact values suitable for offshore constructions
 Consistently good CTOD values with CMn and Ni-alloyed wires
 Low hydrogen content
 Suitable for single/multi wire welding

APPROVALS

Wire grade	BV	ABS	LRS	DNV	CRS	TÜV
L-50M (LNS 133U)	A5YM	5YM	5YM	5YM	5YM	✓
LNS 162						✓
LNS 160						✓
LNS 164						✓
LNS 165		5Y46M	5Y46M	5Y46M		✓
LNS 168			4Y69			

CHEMICAL COMPOSITION (W%), TYPICAL, ALL WELD METAL

Wire grade	C	Mn	Si	P	S	Mo	Ni	Cr
L-61	0.08	1.0	0.35	< 0.010	< 0.010			
L-50M (LNS 133U)	0.08	1.6	0.35	< 0.020	< 0.015			
LNS 160	0.08	1.0	0.25	< 0.020	< 0.015		1.0	
LNS 162	0.08	1.013	0.25	< 0.020	< 0.015		2.2	
LNS 165	0.08	1.2	0.35	< 0.020	< 0.015	0.15	0.9	
LNS 150	0.08	0.7	0.3	< 0.015	< 0.010	0.15		1.1
LNS 151	0.10	1.5	0.3	< 0.015	< 0.010	1.0		2.5
LNS 168	0.08		0.4	< 0.015	< 0.015	0.4	2.4	0.3

MECHANICAL PROPERTIES, TYPICAL, ALL WELD METAL

Wire grade	Condition*	Yield strength [N/mm ²]	Tensile strength [N/mm ²]	Elongation [%]	Impact ISO-V(J)			
					-20°C	-40°C	-50°C	-60°C
L-61	AW	440	530	30	115	75		
L-50M (LNS 133U)	AW	460	560	28				40
	SR	420	540	28				40
	AW	470	550	28				80
LNS 160	SR	430	490	32				100
	AW	480	560	26				100
LNS 162	SR	460	530	30				140
	AW	520	600	25				60
LNS 165	SR	510	580	24				60
	SR	520	610	24				100
LNS 151	SR	550	640	24				50
LNS 168	AW	720	800	20				55

AW : As welded - SR : Stress relieved

P240: rev. C-EN276-11/05/16

All information in this data sheet is accurate to the best of our knowledge at the time of printing. Please refer to www.lincolnelectric.eu for any updated information.
 Fumes: Safety Data Sheets (SDS) are available on our website.

P240

EXAMPLES OF MATERIALS TO BE WELDED

Code	Type / Steel grades	Multi-run					
		L-50M (LNS 133U)	LNS 160	LNS 162	LNS 165	LNS 150	LNS 151
Ship plates							
	A to E	✓	✓	✓	✓		
	AH32 to EH40	✓	✓	✓	✓		
General structural steels							
EN 10025 part 6 (A 36-204)	500 A & AL				✓		
EN 10025 part 3/part 4	S275 to S460 all qualities	✓	✓	✓	✓		
EN 10149 (A36-231)	S315 & S355 MC & NC	✓	✓	✓	✓		
	S315 to S500 MC & NC				✓		
EN 10025 part 2	S185 to E360 all qualities	✓	✓	✓	✓		
Boiler & pressure vessel steels							
EN 10028 (A 36-205)	P235 to P460 all qualities	✓	✓	✓	✓		
EN 10207 (A36-220)	P235 to P275 all qualities	✓	✓	✓	✓		
A36-601 & NF A36-605	A37 to A52 all qualities	✓	✓	✓	✓		
EN 10028-2 (Elevated temperature steel)	13CrMo 4-5					✓	✓
	10CrMo 9-10					✓	✓
Steel for dangerous material transportation							
A 36-215	P265 to P460 all qualities	✓	✓	✓	✓		
Low temperature steels							
A 36-215	P285 to P420 all qualities	✓	✓	✓	✓		

FLUX CHARACTERISTICS

Current type	DC / AC
Basicity (Boniszewski)	3.0
Density (kg/dm ³)	1.1
Grain size (ISO 14174)	2 -20

SUGGESTIONS FOR USE

Boiler and pressure vessels
Off-shore applications
Nuclear components
Low temperature applications
Highly restraint constructions

PACKAGING AND AVAILABLE SIZES

Unit	Net weight (kg)
Sahara ReadyBag™ (SRB)	25

SAW

P2000

CLASSIFICATION

Flux	Wire						
ISO 14174		ISO 14343-A	AWS A5.9/A5.9M			ISO 18274	AWS A5.14/ A5.14M
S A AF 2 64 DC H5	LNS 304L	S 19 9 L	ER308L	LNS NiCro 60/20		S Ni 6625	ERNiCrMo-3
	LNS 309L	S 24 12 L	ER309L	LNS NiCroMo 60/16		S Ni 6276	ERNiCrMo-4
	LNS 316L	S 19 12 3 L	ER316L	LNS NiCro 70/19		S Ni 6082	ERNiCr-3
	LNS 4462	S 22 9 3 N L	ER2209				
	LNS 318	S 19 12 3 Nb	ER318				
	LNS 347	S 19 9 Nb	ER347				
	LNS Zeron® 100X	S 25 9 4 N L	ER2594				
	LNS 4455	S 20 16 3 Mn L	ER316LMn				
	LNS 4500	S 20 25 5 Cu L	ER385				
	LNS 304H	S 19 9 H	ER308H				
LNS 307	S 18 8 Mn	ER307*					

GENERAL DESCRIPTION

Stainless steel welding flux
 Excellent slag release
 Low flux consumption
 Favorite choice with duplex and stabilized grades

APPROVALS

Wire grade	TÜV
LNS 304L	✓
LNS 316L	✓
LNS 318L	✓
LNS 347	✓
LNS 4455	✓

CHEMICAL COMPOSITION (W%), TYPICAL, ALL WELD METAL

Wire grade	C	Mn	Si	Cr	Ni	Mo	N	Nb	Cu	W	FN
LNS 304L	0.015	1.5	0.5	19	10						08-10
LNS 309L	0.015	1.5	0.5	23	13						10-20
LNS 316L	0.015	1.5	0.5	18	12	2.5					08-10
LNS 4462	0.015	1.5	0.5	22	8	3.0	0.1				40-60
LNS 318	0.04	1.5	0.5	19	11	2.5		0.5			08-10
LNS 347	0.03	1.4	0.5	19	10			0.6			08-10
LNS Zeron® 100X	0.03	0.6	0.5	25	9.5	3.6		0.2	0.7	0.6	30-60
LNS NiCro 60/20	0.006	0.1	0.4	21.5	64.5	8.7	3.8			0.8	
LNS 4455	0.025	6	0.5	18.5	15	2.6	0.15				
LNS 4500	0.03	1.5	0.6	19	25	4.1			1.2		

MECHANICAL PROPERTIES, TYPICAL, ALL WELD METAL

Wire grade	Condition*	Yield strength (N/mm ²)	Tensile strength (N/mm ²)	Elongation (%)	Impact ISO-V(J)			
					+20°C	-20°C	-40°C	-196°C
LNS 304L	AW	380	550	35		80		
LNS 309L	AW	425	580	33			80	
LNS 316L	AW	425	560	33				50
LNS 4462	AW	550	800	27				50
LNS Zeron® 100X	AW	670	880	21		70	45	
LNS NiCro 60/20	AW	520	780	40				100
LNS 347	AW	470	620	30	90			35
LNS 4455	AW	360	640	30				
LNS 310	AW	440	600	28				

AW : As welded

P2000: rev. C-EN25-10/01/16

All information in this data sheet is accurate to the best of our knowledge at the time of printing. Please refer to www.lincolnelectric.eu for any updated information.
 Fumes: Safety Data Sheets (SDS) are available on our website.

P2000

EXAMPLES OF MATERIALS TO BE WELDED

AISI	Mat.nr.	EN 10088-1/2	ASTM/AISI	UNS	Wire
304L	1.4306	X2CrNi19-11	(TP) 304L	S30403	LNS 304L
304LN	1.4311	X2CrNiN18-10	(TP) 304LN	S30453	LNS 304L
316LN	1.4406	X2CrNiMoN17-11-2	(TP) 316LN	S31653	LNS 316L
316L	1.4404	X2CrNiMo17-12-2	(TP) 316L	S31603	LNS 316L
316L	1.4435	X2CrNiMo18-14-3	(TP) 316L	S31603	LNS 316L
316LN	1.4429	X2CrNiMoN17-13-3			LNS 316L
304	1.4301	X4CrNi18-10	(TP) 304	S30409	LNS 304L
321	1.4541	X6CrNiTi18-10	(TP) 321	S32100	LNS 304L/347
316	1.4401	X4CrNiMo17-12-2	(TP) 316	S31600	LNS 316L
316	1.4436	X4CrNiMo17-13-3			LNS 316L
347	1.4550	X6CrNiNb18-10	(TP) 347	S34700	LNS 304L/347
318	1.4580	X6CrNiMoNb17-12-2	316Cb	S31640	LNS 316L/318
318	1.4583	X10CrNiMoNb18-12(DIN)			LNS 316L/318
317LN	1.4439	X2CrNiMoN17-13-5	316LN	S31726	4439Mn
	1.4539	X1NCrNiMoCu25-20-5			4500
	1.3952	X2CrNiMoN18-14-3(DIN)			4455
	1.4462	X2CrNiMoN22-5-3			4462
			Zeron® 100	S32760	LNS Zeron® 100 X
	2.4856	NiCr22Mo9Nb(DIN)		N06625	LNS NiCro 60/20
	1.5637	12Ni14 (DIN)			LNS NiCro 60/20
	1.5680	12Ni19 (DIN)			LNS NiCro 60/20
	1.5662	X8Ni9 (DIN)			LNS NiCro 60/20

FLUX CHARACTERISTICS

Current type	DC
Basicity (Boniszewski)	1.6
Solidification speed	High
Density (kg/dm ³)	1.2
Grain size (ISO 14174)	2 -20

SUGGESTIONS FOR USE

General stainless steel welding flux
 Applicable in the boiler and pressure vessel industry as well as pipe fabrication
 Due to low Si-content very good impact toughness at low temperature

PACKAGING AND AVAILABLE SIZES

Unit	Net weight (kg)
Sahara ReadyBag™ (SRB)	25

P2007

CLASSIFICATION

Flux	Wire					
ISO 14174		ISO 14343-A	AWS A5.9/ A5.9M		ISO 18274	AWS A5.14/ A5.14M
S A AF 2 64 AC H5	LNS 304L	S 19 9 L	ER308L	LNS NiCro 60/20	S Ni 6625	ERNiCrMo-3
	LNS 309L	S 24 12 L	ER309L	LNS NiCroMo 60/16	S Ni 6276	ERNiCrMo-4
	LNS 316L	S 19 12 3 L	ER316L	LNS NiCro 70/19	S Ni 6082	ERNiCr-3
	LNS 4462	S 22 9 3 N L	ER2209			
	LNS 318	S 19 12 3 Nb	ER318			
	LNS 347	S 19 9 Nb	ER347			
	LNS Zeron® 100X	S 25 9 4 N L	ER2594			
	LNS 4455	S 20 16 3 Mn L	ER316LMn			
	LNS 4500	S 20 25 5 Cu L	ER385			
	LNS 304H	S 19 9 H	ER308H			
	LNS 307	S 18 8 Mn	ER307*			

GENERAL DESCRIPTION

Stainless steel welding flux
 Excellent slag release
 Homogeneous stainless steel colour bead appearance
 Straight edges on butt welds applications
 Excellent behaviour on 9% Nickel steel
 Suitable in AC current

APPROVALS

Wire grade	ABS	LRS	TÜV
LNS 304L	✓	✓	
LNS 309L	✓	✓	
LNS 316L	✓	✓	
LNS 4462	5YQ550	S31803	✓

CHEMICAL COMPOSITION (W%), TYPICAL, ALL WELD METAL

Wire grade	C	Mn	Si	Cr	Ni	Mo	N	Nb	Cu	W	FN
LNS 304L	0.015	1.5	0.5	19	10						08-10
LNS 309L	0.015	1.5	0.5	23	13						10-20
LNS 316L	0.015	1.5	0.5	18	12	2.5					08-10
LNS 4462	0.015	1.5	0.5	22	8	3.0	0.1				40-60
LNS 318	0.04	1.5	0.5	19	11	2.5		0.5			08-10
LNS 347	0.03	1.4	0.5	19	10			0.6			08-10
LNS Zeron® 100X	0.03	0.6	0.5	25	9.5	3.6		0.2	0.7	0.6	30-60
LNS NiCro 60/20	0.006	0.1	0.4	21.5	64.5	8.7	3.8			0.8	
LNS 4455	0.025	6	0.5	18.5	15	2.6	0.15				
LNS 4500	0.03	1.5	0.6	19	25	4.1			1.2		

AW : As welded

P2007:rev.C-EN04-01/02/16

All information in this data sheet is accurate to the best of our knowledge at the time of printing. Please refer to www.lincolnelectric.eu for any updated information.
 Fumes: Safety Data Sheets (SDS) are available on our website.

P2007

MECHANICAL PROPERTIES, TYPICAL, ALL WELD METAL

Wire grade	Condition*	Yield strength (N/mm ²)	Tensile strength (N/mm ²)	Elongation (%)	Impact ISO-V(J)			
					-20°C	-40°C	-50°C	-196°C
LNS 304L	AW	390	550	35	80	75		40
LNS 309L	AW	400	580	33		70		
LNS 316L	AW	400	560	33	75	70		45
LNS 347	AW	400	650	34			65	
LNS 4462	AW	585	765	27		75		
LNS Zeron® 100X	AW	670	880	21	70	45		
LNS NiCro 60/20	AW	520	780	40				100
LNS 4439Mn		375	630	33				

EXAMPLES OF MATERIALS TO BE WELDED

AISI	Mat.nr.	EN 10088-1/2	ASTM/ACI	UNS	Wire
304L	1.4306	X2CrNi19-11	(TP) 304L	S30403	LNS 304L
304LN	1.4311	X2CrNiN18-10	(TP) 304LN	S30453	LNS 304L
316LN	1.4406	X2CrNiMoN17-11-2	(TP) 316LN	S31653	LNS 316L
316L	1.4404	X2CrNiMo17-12-2	(TP) 316L	S31603	LNS 316L
316L	1.4435	X2CrNiMo18-14-3	(TP) 316L	S31603	LNS 316L
316LN	1.4429	X2CrNiMoN17-13-3			LNS 316L
304	1.4301	X4CrNi18-10	(TP) 304	S30409	LNS 304L
321	1.4541	X6CrNiTi18-10	(TP) 321	S32100	LNS 304L/347
316	1.4401	X4CrNiMo17-12-2	(TP) 316	S31600	LNS 316L
316	1.4436	X4CrNiMo17-13-3			LNS 316L
347	1.4550	X6CrNiNb18-10	(TP) 347	S34700	LNS 304L/347
318	1.4580	X6CrNiMoNb17-12-2	316Cb	S31640	LNS 316L/318
318	1.4583	X10CrNiMoNb18-12(DIN)			LNS 316L/318
317LN	1.4439	X2CrNiMoN17-13-5	316LN	S31726	4439Mn
	1.4539	X1NCrNiMoCu25-20-5			4500
	1.3952	X2CrNiMoN18-14-3(DIN)			4455
	1.4462	X2CrNiMoN22-5-3			4462
	2.4856	NiCr22Mo9Nb(DIN)	Zeron® 100	S32760	LNS Zeron® 100 X
	1.5637	12Ni14 (DIN)		N06625	LNS NiCro 60/20
	1.5680	12Ni19 (DIN)			LNS NiCro 60/20
	1.5662	X8Ni9 (DIN)			LNS NiCro 60/20

FLUX CHARACTERISTICS

Current type	DC (+/-)
Basicity (Boniszewski)	1.6
Solidification speed	High
Density (kg/dm ³)	1.2
Grain size (ISO 14174)	2 - 20

SUGGESTIONS FOR USE

General stainless steel welding flux
 Applicable in the boiler and pressure vessel industry as well as pipe fabrication
 Due to low Si-content very good impact toughness at low temperature

PACKAGING AND AVAILABLE SIZES

Unit	Net weight (kg)
Sahara ReadyBag™ (SRB)	25
Drum	40

P2000S

CLASSIFICATION

Flux	Wire	
ISO 14174		ISO 14343-A
S A AF 2 64Cr DC H5	LNS 309L	S 24 12 L
	LNS 4462	S 22 9 3 N L
	LNS Zeron® 100X	S 25 9 4 N L

GENERAL DESCRIPTION

Compensates Cr-burn off and increases the Cr-content in the weldmetal
 Welding stainless steel to carbon steel
 To be used to weld first layers in carbon steel with over-alloyed wires
 Applicable where a higher weldmetal ferrite is needed

APPROVALS

Wire grade	TÜV
LNS 309L	✓
LNS 4462	✓

CHEMICAL COMPOSITION (W%), TYPICAL, ALL WELD METAL

Wire grade	C	Mn	Si	Cr	Ni	Mo	N	Cu	W	FN
LNS 309L	0.015	1.5	0.5	25	13					15-20
LNS 4462	0.015	1.5	0.5	24	8	3.0	0.1			40-60
LNS Zeron® 100X	0.02	0.5	0.4	26	9	3.7	0.2	0.7	0.6	30-60

MECHANICAL PROPERTIES, TYPICAL, ALL WELD METAL

Wire grade	Yield strength (N/mm ²)	Tensile strength (N/mm ²)	Elongation (%)	Impact ISO-V(J)	
				-40°C	
LNS 309L	450	600	33	80	
LNS 4462	700	850	27	50	
LNS Zeron® 100X	670	880	25	45	

P2000S: rev. C-EN23-01/02/16

P2000S

EXAMPLES OF MATERIALS TO BE WELDED

Dissimilar
Duplex

SUGGESTIONS FOR USE

Especially developed for welding stainless steel to carbon steel. Also to be used in welding root runs in clad steel as well as root runs in Nitrogen alloyed fully austenitic steels to avoid hot cracking

FLUX CHARACTERISTICS

Current type	DC (+/-)
Basicity (Boniszewski)	1.6
Solidification speed	High
Density (kg/dm ³)	1.2
Grain size (ISO 14174)	1-16

PACKAGING AND AVAILABLE SIZES

Unit	Net weight (kg)
Bag	25
Sahara ReadyBag™ (SRB)	25

SAW

Lined area for notes.

PIPELINER® RANGE**Cellulosic Electrodes**

PIPELINER® 6P+	604
PIPELINER® 7P+	606
PIPELINER® 8P+	608

Basic Electrodes

PIPELINER® 16P	610
PIPELINER® 18P	612

High Strength, Basic Electrodes

PIPELINER® LH-D80	614
PIPELINER® LH-D90	616
PIPELINER® LH-D100	618

Solid Wires

PIPELINER® 70S-G	620
PIPELINER® 80S-G	621
PIPELINER® 80Ni1	622

Flux-cored Wires

PIPELINER® G60M-E	624
PIPELINER® G70M	626
PIPELINER® G70M-E	628
PIPELINER® G80M	630
PIPELINER® G80M-E	632
PIPELINER® G90M-E	634
PIPELINER® NR®-207+	636
PIPELINER® NR®-208XP	638

Pipeliner® 6P+

CLASSIFICATION

AWS A5.1	E6010	A-Nr	1
ISO 2560-A	E 42 3 C 2 5	F-Nr	3
		9606 FM	1

GENERAL DESCRIPTION

All-position cellulosic pipe electrode designed for all position pipe welding, including vertical down root pass welding
 Designed for root pass welding of pipe up to and including X80, fill and cap pass welding up to and including X60
 Light slag with little slag interference for easy arc control
 Easy slag release and smooth bead appearance
 Deep penetration with maximum dilution
 X-ray quality welds, even out of position

WELDING POSITIONS (ISO/ASME)



PA/1G



PB/2F



PC/2G



PF/3Gu



PG/3Gd



PE/4G



PH/5Gu



PJ/5Gd

CURRENT TYPE

DC +/-

CHEMICAL COMPOSITION (W%), TYPICAL, ALL WELD METAL

C	Mn	Si	P	S
0.11	0.55	0.18	0.009	0.009

MECHANICAL PROPERTIES, TYPICAL, ALL WELD METAL

Condition	Yield strength (N/mm ²)	Tensile strength (N/mm ²)	Elongation (%)	Impact ISO-V(J) -29°C/-30°C
Required: AWS A5.1 ISO 2560-A	min. 331	min. 430	min. 22	min. 27
Typical values	min. 420 450	500-640 570	min. 20 27	min. 47 70

PACKAGING AND AVAILABLE SIZES

	Diameter (mm)	2.5	3.2	4.0
	Length (mm)	300	350	350
Metal can	Net weight/unit (kg)	4.7	4.5	4.5

Identification Imprint: 6010 Tip Color: none

Pipeliner® 6P+ rev. C-EN23-01/02/16

All information in this data sheet is accurate to the best of our knowledge at the time of printing. Please refer to www.lincolnelectric.eu for any updated information.
 Fumes: Safety Data Sheets (SDS) are available on our website.

Pipeliner® 6P+

EXAMPLES OF MATERIALS TO BE WELDED

Steel grades/Code	Type
Pipe material	
API 5LX	X42, X46, X52, X56, X60
EN 10208-2	L290 up to L415

CALCULATION DATA

Sizes Diam. x length (mm)	Current range (A)	Current type
2.5x300	50-85	DC+/-
3.2x350	75-135	DC+/-
4.0x350	100-175	DC+/-

*Stub end 35mm

WELDING PARAMETERS, OPTIMUM FILL PASSES

Diameter (mm)	Welding positions	
	PH/5Gup	PJ/5Gdown
3.2	90A	110A
4.0	130A	150A

REMARKS / APPLICATION ADVICE

Preheating pipe material L415 (X56-X60) required (acc. EN 1011-2).

Pipeclamps to be removed after finishing root pass, start welding hot pass (within 5 min) after root pass

Use electrodes directly from Metal cans

Pipeliner[®] 7P+

CLASSIFICATION

AWS A5.1	E7010-P1	A-Nr	1
ISO 2560-A	E 42 3 Z C 2 5	F-Nr	3
		9606 FM	1

GENERAL DESCRIPTION

Cellulosic electrode for vertical down pipe welding
 Suitable for hot, fill and cap pass of up to X60 grade pipe
 Clean, visible weld puddle
 Deep penetration and excellent puddle control
 Root pass welding up to X80 grade pipe

WELDING POSITIONS (ISO/ASME)



PA/1G



PB/2F



PC/2G



PF/3Gu



PG/3Gd



PE/4G



PH/5Gu



PJ/5Gd

CURRENT TYPE

DC +

APPROVALS

ABS

+

CHEMICAL COMPOSITION (W%), TYPICAL, ALL WELD METAL

C	Mn	Si	P	S	Ni	Mo
0.15	0.6	0.1	0.015	0.015	0.85	0.1

MECHANICAL PROPERTIES, TYPICAL, ALL WELD METAL

	Condition	Yield strength (N/mm ²)	Tensile strength (N/mm ²)	Elongation (%)	Impact ISO-V(J)	
					-29°C	-40°C
Required: AWS A5.1 ISO 2560-A Typical values	AW	min. 415 min. 420 470	min. 490 500-640 570	min. 22 min. 20 24	27 47 80	70

PACKAGING AND AVAILABLE SIZES

	Diameter (mm)	3.2	4.0	5.0
	Length (mm)	350	350	450
Metal can	Net weight/unit (kg)	22.7	22.7	22.7

Identification Imprint: 7010-P1

Tip Color:

Pipeliner[®] 7P+ rev. C-EN02-01/02/16

All information in this data sheet is accurate to the best of our knowledge at the time of printing. Please refer to www.lincolnelectric.eu for any updated information.
 Fumes: Safety Data Sheets (SDS) are available on our website.

Pipeliner[®] 7P+

EXAMPLES OF MATERIALS TO BE WELDED

Steel grades/Code	Type
Pipe material	
API 5LX	X42, X46, X52, X56, X60
EN 10208-2	L290 up to L415

CALCULATION DATA

Sizes Diam. x length (mm)	Current range (A)	Current type
3.2x350	65-130	DC+
4.0x350	100-165	DC+
5.0x450	130-210	DC+

*Stub end 35mm

WELDING PARAMETERS, OPTIMUM FILL PASSES

Diameter (mm)	Welding positions	
	PJ/5Gdown	
3.2	110A	
4.0	150A	
5.0	165A	

REMARKS / APPLICATION ADVICE

Preheating pipe material L360-L415 (X52-X60) required (acc. EN 1011-2).
 Pipeclamps to be removed after finishing root pass, start welding hot pass (within 5 min) after root pass
 Use electrodes directly from Metal cans

Pipeliner[®] 8P+

CLASSIFICATION

AWS A5.5	E8010-P1	A-Nr	10
ISO 2560-A	E 46 4 1Ni C 2 5	F-Nr	3
		9606 FM	1

GENERAL DESCRIPTION

Designed for vertical down welding of pipes up to and including X70
 Excellent resistance to porosity, X-ray quality welds
 High stacking efficiency: fill joints in fewer passes
 Exceptional mechanical properties
 Root pass welding up to X80 grade pipe

WELDING POSITIONS (ISO/ASME)



PA/1G



PB/2F



PC/2G



PF/3Gu



PG/3Gd



PE/4G



PH/5Gu



PJ/5Gd

CURRENT TYPE

DC +

APPROVALS

ABS

+

CHEMICAL COMPOSITION (W%), TYPICAL, ALL WELD METAL

C	Mn	Si	Ni	Mo	P	S
0.17	0.7	0.25	0.8	0.2	0.01	0.01

MECHANICAL PROPERTIES, TYPICAL, ALL WELD METAL

	Condition	Yield strength (N/mm ²)	Tensile strength (N/mm ²)	Elongation (%)	Impact ISO-V(J)		
					-29°C	-40°C	-46°C
Required: AWS A5.5 ISO 2560-A Typical values	AW	min. 460 min. 460 495	min. 550 530-680 590	min. 19 min. 20 24	min. 27 80	min. 47 60	50

PACKAGING AND AVAILABLE SIZES

	Diameter (mm)	3.2	4.0	5.0
	Length (mm)	350	350	350
Metal can	Net weight/unit (kg)	4.5	4.5	4.5

Identification Imprint: 8010-P1 PIPELINER 8P+ Tip Color: none

Pipeliner[®] 8P+ rev. C-EN22-01/02/16

All information in this data sheet is accurate to the best of our knowledge at the time of printing. Please refer to www.lincolnelectric.eu for any updated information.
 Fumes: Safety Data Sheets (SDS) are available on our website.

Pipeliner[®] 8P+

EXAMPLES OF MATERIALS TO BE WELDED

Steel grades/Code	Type
Pipe material	
API 5LX	X56, X60, X65, X70
EN 10208-2	L360 up to L485

CALCULATION DATA

Sizes Diam. x length (mm)	Current range (A)	Current type
3.2x350	65-120	DC+
4.0x350	100-165	DC+
5.0x350	130-210	DC+

*Stub end 35mm

WELDING PARAMETERS, OPTIMUM FILL PASSES

Diameter (mm)	Welding positions	
	PH/5Gup	PJ/5Gdown
3.2	90A	110A
4.0	130A	150A
5.0	150A	165A

REMARKS / APPLICATION ADVICE

Preheating pipe material L360 - L485 (X56 - X70) required (acc. EN 1011-2).
 Pipeclamps to be removed after finishing root pass, start welding hot pass (within 5 min) after root pass
 Use electrodes directly from Metal cans
 Use PIPELINER 6P+ for lower hardness in the root pass when required

Pipeliner® 16P

CLASSIFICATION

AWS A5.1	E7016 H4	A-Nr	1
ISO 2560-A	E 42 3 B 1 2 H5	F-Nr	4
		9606 FM	1

GENERAL DESCRIPTION

Designed for vertical up root pass welding of pipes up to and including X100
 Suitable for hot, fill, and cap pass welding for up to and including X60
 Excellent low temperature impact properties
 Square burnoff makes welding easier, especially in critical pipe welding applications
 Open gap root pass welding with 2.5 and 3.2 mm electrodes using DC - / + polarity

WELDING POSITIONS (ISO/ASME)



PA/1G



PB/2F



PC/2G



PF/3Gu



PE/4G



PH/5Gu

CURRENT TYPE

AC/DC+

CHEMICAL COMPOSITION (W%), TYPICAL, ALL WELD METAL

C	Mn	Si	P	S
0.06	1.3	0.5	0.013	0.009

MECHANICAL PROPERTIES, TYPICAL, ALL WELD METAL

Condition	Yield strength (N/mm ²)	Tensile strength (N/mm ²)	Elongation (%)	Impact ISO-V(J)	
				-29°C/ -30°C	-40°C
Required: AWS A5.1 ISO 2560-A Typical values	min. 400 min. 420 470	min. 490 500-640 590	min. 22 min. 20 26	min. 27 min. 47 120	90

PACKAGING AND AVAILABLE SIZES

	Diameter (mm)	2.5	3.2	4.0
	Length (mm)	350	350	350
Metal can	Net weight/unit (kg)	22.7	22.7	22.7

Identification Imprint: 7016 H4 PIPELINER 16P Tip Color: none

Pipeliner®16P: rev. C-EN23-01/02/16

All information in this data sheet is accurate to the best of our knowledge at the time of printing. Please refer to www.lincolnelectric.eu for any updated information.
 Fumes: Safety Data Sheets (SDS) are available on our website.

Pipeliner[®] 16P

EXAMPLES OF MATERIALS TO BE WELDED

Steel grades/Code	Type
Pipe material	
API 5LX	X42, X46, X52, X56, X60
EN 10208-2	L290 up to L415

CALCULATION DATA

Sizes Diam. x length (mm)	Current range (A)	Current type
2.5x350	55-105	DC+
3.2x350	75-135	DC+
4.0x350	120-170	DC+

*Stub end 35mm

WELDING PARAMETERS, OPTIMUM FILL PASSES

Diameter (mm)	Welding positions				
	PA/1G	PB/2F	PC/2G	PF/3Gup	PE/4G
2.5	80A	85A	85A	85A	80A
3.2	120A	115A	115A	115A	110A
4.0	170A	180A	180A	180A	160A

REMARKS / APPLICATION ADVICE

Preheating pipe material L360 - L415 [X52 - X60] required (acc. EN 1011-2).

Pipeliner® 18P

CLASSIFICATION

AWS A5.5	E 8018-G-H4R	A-Nr	10
ISO 2560-A	E 50 6 MnNi B 3 2 H5	F-Nr	4
		9606 FM	2

GENERAL DESCRIPTION

Designed for vertical up fill and cap pass welding of welding of high strength pipe up to and including X70
 Excellent low temperature impact properties down to -60°C
 Square burnoff makes welding easier, especially in critical pipe welding applications

WELDING POSITIONS (ISO/ASME)



PA/1G



PB/2F



PC/2G



PF/3Gu



PE/4G



PH/5Gu

CURRENT TYPE

AC / DC + / -

CHEMICAL COMPOSITION (W%), TYPICAL, ALL WELD METAL

C	Mn	Si	P	S	Ni
0.05	1.5	0.5	0.010	0.009	0.95

MECHANICAL PROPERTIES, TYPICAL, ALL WELD METAL

Condition	Yield strength [N/mm ²]	Tensile strength [N/mm ²]	Elongation [%]	Impact ISO-V(J)	
				-40°C	-60°C
Required: AWS A5.5 ISO 2560-A Typical values	min. 460 min. 500 550	min. 550 560-720 640	min. 19 min. 18 24	140	min. 47 80

PACKAGING AND AVAILABLE SIZES

	Diameter (mm)	3.2	4.0
	Length (mm)	350	350
Metal can	Pieces / unit	139	75
	Net weight/unit (kg)	4.2	4.0

Identification Imprint: 8018-G H4R PIPELINER 18P Tip Color: none

Pipeliner®18P: rev. C-EN23-01/02/16

All information in this data sheet is accurate to the best of our knowledge at the time of printing. Please refer to www.lincolnelectric.eu for any updated information.
 Fumes: Safety Data Sheets (SDS) are available on our website.

Pipeliner® 18P

EXAMPLES OF MATERIALS TO BE WELDED

Steel grades/Code	Type
Pipe material	
API 5LX	X 56, X60, X65, X70, X80
EN 10208-2	L360 up to L485

CALCULATION DATA

Sizes Diam. x length (mm)	Current range (A)	Current type	Arc time - per electrode at max. current - (S)*	Energy E(kJ)	Dep. rate H(kg/h)	Weight/ 1000 pcs (kg)	Electrodes/ kg weld- metal B	kg electrodes/ kg weldmetal 1/N
3.2x350	80-145	DC+	66	220	1.2	377	48	1.79
4.0x350	120-185	DC+	77	355	1.6	54.1	29	1.59

*Stub end 35mm

WELDING PARAMETERS, OPTIMUM FILL PASSES

Diameter (mm)	Welding positions					
	PA/1G	PB/2F	PC/2G	PF/3Gup	PE/4G	PH/5Gup
3.2	140A	120A	145A	120A	120A	120A
4.0	150A	140A	150A	140A	140A	140A

REMARKS / APPLICATION ADVICE

Preheating pipe material L360 - L485 (X56 - X70) required (acc. EN 1011-2).

Pipeliner® LH-D80

CLASSIFICATION

AWS A5.5	E8045-P2 H4R	A-Nr	1
ISO 2560-A	E 46 4 Z B 4 5 H5	F-Nr	4
		9606 FM	1/2

GENERAL DESCRIPTION

Specifically designed for vertical down

Basic covered low hydrogen electrode primarily designed for vertical down hot, fill and cap pass pipe welding

Recommended for pipe grades up to and including X70

Low temperature impact properties down to -46°C.

Unique "hot start" tip helps initiate the arc and quickly establish puddle control

Slag design allows for easy control of weld puddle

WELDING POSITIONS (ISO/ASME)



PG/3Gd



PJ/5Gd

CURRENT TYPE

AC / DC + / -

CHEMICAL COMPOSITION (W%), TYPICAL, ALL WELD METAL

C	Mn	Si	P	S
0.05	1.15	0.45	0.009	0.009

MECHANICAL PROPERTIES, TYPICAL, ALL WELD METAL

Condition	Yield strength (N/mm ²)	Tensile strength (N/mm ²)	Elongation (%)	Impact ISO-V(J)	
				-30°C	-46°C
Required: AWS A5.5 ISO 2560-A	min. 460	min. 550	min. 19	min. 27	min. 27
Typical values	490	530-680	27	80	50-95

PACKAGING AND AVAILABLE SIZES

	Diameter (mm)	3.2	4.0	4.5
	Length (mm)	350	350	350
Metal can	Net weight/unit (kg)	4.5	4.5	4.5

Identification Imprint: LH-D80 8018-G Tip Color: none

Pipeliner® LH-D80: rev. C-EN23-01/02/16

All information in this data sheet is accurate to the best of our knowledge at the time of printing. Please refer to www.lincolnelectric.eu for any updated information.
Fumes: Safety Data Sheets (SDS) are available on our website.

Pipeliner® LH-D80

EXAMPLES OF MATERIALS TO BE WELDED

Steel grades/Code	Type
Pipe material	
API 5LX	X60, X65, X70
EN 10208-2	L415 up to L485

CALCULATION DATA

Sizes Diam. x length (mm)	Current range (A)	Current type
3.2x350	120-170	DC+
4.0x350	170-250	DC+
4.5x350	200-300	DC+

*Stub end 35mm

WELDING PARAMETERS, OPTIMUM FILL PASSES

Diameter (mm)	Welding positions PJ/5Gdown
3.2	140-170A
4.0	180-240A
4.5	200-260A

Pipeliner® LH-D90

CLASSIFICATION

AWS A5.5	E9045-P2 H4R	A-Nr	10
ISO 18275-A	E 55 4 ZB 4 5 H5	F-Nr	4
		9606 FM	2

GENERAL DESCRIPTION

Basic covered low hydrogen electrode primarily designed for vertical down hot, fill and cap pass pipe welding
 Recommended for pipe grades up to and including API 5L Grade X80
 High deposition rates and excellent low temperature impact properties down to -46°C.
 Unique "hot start" tip helps initiate the arc and quickly establish puddle control
 Slag design allows for easy control of weld puddle

WELDING POSITIONS (ISO/ASME)



PG/3Gd



PJ/5Gd

CURRENT TYPE

AC / DC + / -

CHEMICAL COMPOSITION (W%), TYPICAL, ALL WELD METAL

C	Mn	Si	P	S	Ni	Cr	Mo
0.05	1.30	0.5	0.009	0.009	0.25	0.05	0.2

MECHANICAL PROPERTIES, TYPICAL, ALL WELD METAL

Condition	Yield strength (N/mm ²)	Tensile strength (N/mm ²)	Elongation (%)	Impact ISO-V(J)		
				-29°C	-40°C	-46°C
Required: AWS A5.5 ISO 18275-A Typical values	min. 530 min. 550 575	min. 620 610-780 645	min. 17 min. 18 27	min. 27 95	min. 47	60

PACKAGING AND AVAILABLE SIZES

	Diameter (mm)	3.2	4.0
	Length (mm)	350	350
Metal can	Net weight/unit (kg)	4.5	4.5

Identification Imprint: LH-D90 Tip Color: none

Pipeliner® LH-D90: rev. C-EN24-01/02/16

All information in this data sheet is accurate to the best of our knowledge at the time of printing. Please refer to www.lincolnelectric.eu for any updated information.
 Fumes: Safety Data Sheets (SDS) are available on our website.

Pipeliner® LH-D90

EXAMPLES OF MATERIALS TO BE WELDED

Steel grades/Code	Type
Pipe material	
API 5LX	X65, X70, X80
EN 10208-2	L415 up to L555

CALCULATION DATA

Sizes Diam. x length (mm)	Current range (A)	Current type
3.2x350	120-170	DC+
4.0x350	170-250	DC+
4.5x350	200-300	DC+

*Stub end 35mm

WELDING PARAMETERS, OPTIMUM FILL PASSES

Diameter (mm)	Welding positions PJ/5Gdown
3.2	140-170A
4.0	180-240A
4.5	200-260A

Pipeliner® LH-D100

CLASSIFICATION

AWS A5.5	E10045-P2 H4R	A-Nr	10
		F-Nr	4
		9606 FM	2

GENERAL DESCRIPTION

Basic covered low hydrogen electrode primarily designed for vertical down hot, fill and cap pass pipe welding
 Recommended for pipe grades up to and including API 5L Grade X90
 High deposition rates and excellent low temperature impact properties down to -46°C.
 Unique "hot start" tip helps initiate the arc and quickly establish puddle control
 Slag design allows for easy control of weld puddle

WELDING POSITIONS (ISO/ASME)



PG/3Gd



PJ/5Gd

CURRENT TYPE

AC / DC + / -

CHEMICAL COMPOSITION (W%), TYPICAL, ALL WELD METAL

C	Mn	Si	P	S	Ni	Mo
0.05	1.55	0.45	0.009	0.009	0.9	0.45

MECHANICAL PROPERTIES, TYPICAL, ALL WELD METAL

Condition	Yield strength [N/mm ²]	Tensile strength [N/mm ²]	Elongation [%]	Impact ISO-V(J)		
				-29°C	-46°C	
Required: AWS A5.5 Typical values	AW	min. 600 650	min. 690 730	min. 16 24	min. 27 100	70

PACKAGING AND AVAILABLE SIZES

	Diameter (mm)	3.2	4.0
	Length (mm)	350	350
Metal can	Net weight/unit (kg)	4.5	4.5

Identification Imprint: LH-D100 10018-G Tip Color: none

Pipeliner® LH-D100: rev. C-EN24-01/02/16

All information in this data sheet is accurate to the best of our knowledge at the time of printing. Please refer to www.lincolnelectric.eu for any updated information.
 Fumes: Safety Data Sheets (SDS) are available on our website.

Pipeliner® LH-D100

EXAMPLES OF MATERIALS TO BE WELDED

Steel grades/Code	Type
Pipe material	
API 5LX	X70, X80, X90
EN 10208-2	L415 up to L620

CALCULATION DATA

Sizes Diam. x length (mm)	Current range (A)	Current type
3.2x350	120-170	DC+
4.0x350	170-250	DC+
4.5x350	200-300	DC+

*Stub end 35mm

WELDING PARAMETERS, OPTIMUM FILL PASSES

Diameter (mm)	Welding positions PJ/5Gdown
3.2	20-170A
4.0	170-250A
4.5	200-300A

Pipeliner[®] 70S-G

CLASSIFICATION

AWS A5.18	ER70S-G	A-Nr	1	Mat-Nr	1.5112
EN ISO 14341-A	G 38 3 M G2Si / G 38 3 C G2Si	F-Nr	6		
		9606 FM	1		

GENERAL DESCRIPTION

Specially intended and packaged for the needs of semiautomatic and automatic root pass pipe welding
 Fluid puddle provides good wash-in at the weld toes and uniform bead shape
 Clean weld deposit
 Foil bag packaging guards against moisture
 Consistent X-ray quality welds
 Primarily intended for all position welding on pipe steels such as API 5L X42 through X60
 Suitable for welding root passes for up to and including API 5L X80

WELDING POSITIONS (ISO/ASME)



PA/1G



PB/2F



PC/2G



PF/3Gu



PE/4G

SHIELDING GASES (ACC. ISO 14175)

M21	Mixed gas Ar+ >15-25% CO ₂
C1	Active gas 100% CO ₂

CHEMICAL COMPOSITION (W%) TYPICAL WIRE

C	Mn	Si	P	S
0.07	1.25	0.55	0.01	0.02

MECHANICAL PROPERTIES, TYPICAL, ALL WELD METAL

	Shielding gas	Condition	Yield strength (N/mm ²)	Tensile strength (N/mm ²)	Elongation (%)	Impact ISO-V(J) -29°C
Typical values	C1	AW	425	525	25	80

EXAMPLES OF MATERIALS TO BE WELDED

Steel grades/Code	Type
Pipe material	
API 5LX	X42, X46, X52, X60
EN 10208-2	L290 up to L415

PACKAGING AND AVAILABLE SIZES

Diameter (mm)	1.1	1.3
4.5 kg plastic spool S200	X	X
11.34 kg coil 22RR	X	X

 PIPELINER[®] 70S-G; rev. C-EN24-01/02/16

Pipeliner® 80S-G

CLASSIFICATION

AWS A5.18	ER80S-G	A-Nr	1	Mat-Nr	1.5130
EN ISO 14341-A	G 50 3 M G4S1i	F-Nr	6		
		9606 FM	1/2		

GENERAL DESCRIPTION

Specially intended and packaged for the needs of semiautomatic and automatic root pass pipe welding
 Fluid puddle provides good wash-in at the weld toes and uniform bead shape
 Clean weld deposit
 Foil bag packaging guards against moisture
 Consistent X-ray quality welds
 Primarily intended for all position welding on pipe steels such as API 5L X65 through X80

WELDING POSITIONS



ISO/ASME

PA/1G

PB/2F

PC/2G

PF/3Gu

PE/4G

SHIELDING GASES (ACC. ISO 14175)

M21 Mixed gas Ar+ >15-25% CO₂

CHEMICAL COMPOSITION (W%) TYPICAL WIRE

C	Mn	Si	P	S
0.09	1.55	0.60	0.012	0.007

MECHANICAL PROPERTIES, TYPICAL, ALL WELD METAL

	Shielding gas	Condition	Yield strength [N/mm ²]	Tensile strength [N/mm ²]	Elongation [%]	Impact ISO-V(J) -29°C
Typical values	M21	AW	634	710	23	140

EXAMPLES OF MATERIALS TO BE WELDED

Steel grades/Code	Type
Pipe material	
API 5LX	X42, X46, X52, X60
EN 10208-2	L450 up to L555

PACKAGING AND AVAILABLE SIZES

Diameter (mm)	1.1	1.3
4.5 kg plastic spool S200	X	X
11.34 kg coil 22RR	X	X

PIPELINER® 80S-G: rev. C-EN24-01/02/16

Pipeliner® 80Ni1

CLASSIFICATION

AWS A5.28	ER80S-G	A-Nr	1	Mat-Nr	1.5112
EN ISO 14341-A	G 3Ni1	F-Nr	6		
		9606 FM	1/2		

GENERAL DESCRIPTION

Pipeliner® 80Ni1 micro-alloyed MIG wire is designed for semi-automatic or automatic welding of root, hot, fill and cap passes on up to X80 grade pipe and root passes on up to X100 grade pipe. Capable of producing Charpy V-Notch impact properties of 70 J @ -50°C with M20/M21 shielding gas. Pipeliner® 80Ni1 is designed for tough pipeline jobs. For an electrode that meets the expanding demands of higher strength pipe and severe conditions - choose Pipeliner® 80Ni1.

WELDING POSITIONS (ISO/ASME)



PA/1G



PB/2F



PC/2G



PG/3Gd



PE/4G



PJ/5Gd

SHIELDING GASES (ACC. ISO 14175)

M20/M21 C1	75 - 95% Argon / Balance CO ₂ 100% CO ₂
---------------	---

CHEMICAL COMPOSITION (W%), TYPICAL, WIRE

C	Mn	Si	P	S	Ni	Mo	Ti	Al
0.07	1.55	0.70	0.11	0.10	0.90	<0.01	0.08	<0.01

MECHANICAL PROPERTIES, TYPICAL, ALL WELD METAL

Condition	Yield strength (N/mm ²)	Tensile strength (N/mm ²)	Elongation (%)	Impact ISO-V(J)	
				-29°C	-50°C
Required: AWS A5.28		min. 550			
AW C1	600	665	28	80	45
AW M20	650	730	27	110	70

PACKAGING AND AVAILABLE SIZES

Diameter (mm)	1.0	1.2
4.5 kg plastic spool S200	X	X
11.34 kg coil 22RR	X	X

Pipeliner®80Ni1: rev. C-EN03-01/02/16

All information in this data sheet is accurate to the best of our knowledge at the time of printing. Please refer to www.lincolnelectric.eu for any updated information.
Fumes: Safety Data Sheets (SDS) are available on our website.

Pipeliner® 80Ni1

EXAMPLES OF MATERIALS TO BE WELDED

Steel grades/Code	Type
Pipe material	
API 5LX	X42, X46, X52, X56, X60, X65, X70, X80
EN 10208-2	L290 up to L555

CALCULATION DATA

Diameter (mm)	Electrical stick-out (mm)	Wire Feed Speed (cm/min)	Current (A)	Arc Voltage (V)	Deposition rate (kg/h)
1.0	19	250-1400	105-320	19-31	1.0-5.2
1.2	19	320-1270	145-360	19-31	1.7-6.5

Pipelin[®]er G60M-E

CLASSIFICATION

AWS A5.20	E71T1-1M-JH4	A-Nr	Mat-Nr
AWS A5.36	E71T-1M21A4-CS1-JH4	F-Nr	
EN ISO 17632-A	T 46 4 P M 1 H5	9606 FM	

GENERAL DESCRIPTION

Flux cored wire for mechanized and semiautomatic welding with increased deposition rate (kg/h)
 Perfect bead profile for fill and cap passes, easy to remove reduces cleaning time and improves operating factor
 Concentrated and deeply penetrating arc helps to achieve defect free welds
 Focused and clearly visible arc column offers easier welding and reduces operator training time
 Stable mechanical properties over wide range of heat input, CVN > 47J at -40°C
 Very low hydrogen (HDM <4 ml/100g) and long term resistance against moisture pick-up

WELDING POSITIONS (ISO/ASME)

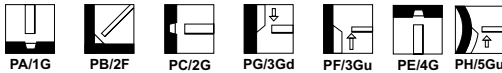

CURRENT TYPE

DC +
 M21 : Mixed gas Ar+ (>15-25%) CO₂
 Amount : 15-25 l/min

APPROVALS

Shielding gas	ABS
M21	+

CHEMICAL COMPOSITION (W%), TYPICAL, ALL WELD METAL

Shielding gas	C	Mn	Si	Ni	P	S	HDM
M21	0.04	1.35	0.25	0.45	0.013	0.008	3ml/100g

MECHANICAL PROPERTIES, TYPICAL, ALL WELD METAL

	Shielding gas	Condition	Yield strength (N/mm ²)	Tensile strength (N/mm ²)	Elongation (%)	Impact ISO-V(J)		
						-20°C	-30°C	-40°C
Required: AWS A5.20 ISO 17632-A			min. 400 min. 460	min. 480 530-680	min. 22 min. 20			min. 47
Typical values	M21	AW	485	540	23	135	120	85

PACKAGING AND AVAILABLE SIZES

Diameter (mm)	1.2
5.0 kg plastic spool S200	X
15 Kg spool B300	X
15 Kg spool S300 Al bag	X

Pipelin[®]er G60ME: rev. C-EN04-11/05/16

Pipeliner® G60M-E

EXAMPLES OF MATERIALS TO BE WELDED

Steel grades/Standard	Type
General structural steels	
EN10027-1	S235 - S460; J2, K2, N and NL, M and ML
Ship plates	
ASTM, ABS, DNV	Grade A, D, EH32 to 40; NV A,D,E 32-40; NV A,D,E 420-460
Pipe material	
ISO 3183	L245-L415N, L245-L450Q, L245M - L450M
API 5LX	X42, X46, X52, X60, X65
Boiler & pressure vessel steels	
EN 10028-3	P235-460, N, NH, NL
EN 10028-2	P235-355GH
Fine grained steels	
EN 10025-2, -3, -4	S235, S275; S355, S420, S420, S460, S460, S460, S460 N, NL, M, ML
EN 10025	S355G, S420G grades
EN 10025-2, -3, -4	S235, S275; S355, S420, S420, S460, S460, S460, S460 N, NL, M, ML
EN 10025 -6	S460Q, QL

CALCULATION DATA

Diameter (mm)	Electrical stick-out (mm)	Wire Feed Speed (cm/min)	Current (A)	Arc Voltage (V)	Deposition rate (kg/h)	kg wire/kg weldmetal
1.2	20	445	120	21-23	1.75	1.13
		700	160	22-24	2.54	1.13
		955	200	25-27	3.45	1.13
		1270	240	27-29	4.73	1.13
		1590	270	30-32	6.2	1.13

WELDING PARAMETERS, OPTIMUM FILL AND CAP PASSES IN SHIELDING GAS AR + [$>15-25$]% CO₂

Diameter (mm)	Welding positions				
	PA/1G	PB/2F	PC/2G	PF/3Gup	PE/4G
1.2	130-280A	150-280A	150-230A	160-240A	150-220A
	22-32V	23-32V	23-30V	23-27V	23-28V

Pipeliner® G70M

CLASSIFICATION

AWS A5.20	E71T-1M-JH8 / E71T-9M-JH8	A-Nr	1
EN ISO17632-A	T 46 4 P M 2 H10	F-Nr	6
		9606 FM	1

GENERAL DESCRIPTION

Mix gas shielded flux cored wire for semi-automatic and mechanized hot, fill and cap pass pipeline welding
Smooth, spray type arc transfer and low spatter level

Slag system provides for puddle support, good wetting and bead shape in all positions

All position single and multiple pass wire designed fo join pipe up to and including X70

Reliable weld metal properties

For the root pass, Pipeliner 70S-G is recommended

Excellent wire feeding

In diameter 1.3 mm [0.052"] the wire is called PIPELINER AUTOWELD® G70M, and is designed to use with mechanized pipe welding systems.

PIPELINER AUTOWELD® G70M has tightly controlled cast and helix to assure proper wire placement every time

WELDING POSITIONS (ISO/ASME)



PA/1G



PB/2F



PC/2G



PG/3Gd



PE/4G



PJ/5Gd

CURRENT TYPE

DC +	
M21	: Mixed gas Ar+ (>15-25%) CO ₂
Amount	: 15-25 l/min

CHEMICAL COMPOSITION (W%), TYPICAL, ALL WELD METAL

Shielding gas	C	Mn	Si	P	S	Ni
M21	0.05	1.45	0.40	0.013	0.011	0.35

MECHANICAL PROPERTIES, TYPICAL, ALL WELD METAL

	Shielding gas	Condition	Yield strength	Tensile strength	Elongation	Impact ISO-V(J)
			[N/mm ²]	[N/mm ²]		-40°C
Required: AWS A5.20			min. 400	min. 480	min. 22	min. 27
ISO 17632-A			min. 460	530-680	min. 20	min. 47
Typical values	M21	AW	560	645	26	125

PACKAGING AND AVAILABLE SIZES

Diameter (mm)	1.1	1.3
4.5 kg plastic spool S200	X	X
11.34 kg coil 22RR	X	X

Pipeliner® G70M; rev. C-EN23-01/02/16

Pipeliner® G70M

EXAMPLES OF MATERIALS TO BE WELDED

Steel grades/Code	Type
Pipe material	
API 5LX	X42, X46, X52, X56, X60, X65, X70
EN 10208-2	L290 up to L485

CALCULATION DATA

Diameter (mm)	Electrical stick-out (mm)	Wire Feed Speed (cm/min)	Current (A)	Arc Voltage (V)	Deposition rate (kg/h)	kg wire/ kg weldmetal
1.1	19	440-1020	130-275	23-30	1.8-5.4	1.21
1.3	19	380-1140	155-315	22-31	1.6-4.9	1.22

Pipeliner® G70M-E

CLASSIFICATION

AWS A5.29 : E81T1-GM-H4
 EN ISO : T 50 5 Z P M 2 H5
 17632-A

GENERAL DESCRIPTION

All position gas shielded 1% Ni, 0.15% Mo flux cored wire
 Specifically designed for pipeline applications
 Superior weldability, low spatter, good bead appearance
 Outstanding operators appeal
 Exceptional mechanical properties (CVN >47J at -50°C)
 Very low hydrogen (HDM <5 ml/100g)
 Superior product consistency with optimal alloy control
 Excellent wire feeding

WELDING POSITIONS (ISO/ASME)



PA/1G



PB/2F



PC/2G



PG/3Gd



PE/4G



PJ/5Gd



PH/5Gu

CURRENT TYPE

DC +
 M21 : Mixed gas Ar+ (>15-25%) CO₂
 Amount : 15-25 l/min

CHEMICAL COMPOSITION (W%), TYPICAL, ALL WELD METAL

Shielding gas	C	Mn	Si	P	S	Ni	Mo
M21	0.06	1.5	0.2	0.013	0.010	0.95	0.15

MECHANICAL PROPERTIES, TYPICAL, ALL WELD METAL

	Shielding gas	Condition	Yield strength (N/mm ²)	Tensile strength (N/mm ²)	Elongation (%)	Impact ISO-V(J)		
						-20°C	-40°C	-50°C
Required: AWS A5.29 ISO 17632-A			min. 470 min. 500	550-690 560-720	min. 19 min. 18			min. 47
Typical values	M21	AW	580	630	23	100	90	70

PACKAGING AND AVAILABLE SIZES

Diameter (mm)	1.2
4.5 kg plastic spool S200	X
15 Kg spool B300	X

Pipeliner® G70ME: rev. C-EN07-09/05/16

All information in this data sheet is accurate to the best of our knowledge at the time of printing. Please refer to www.lincolnelectric.eu for any updated information.
 Fumes: Safety Data Sheets (SDS) are available on our website.

Pipeliner® G70M-E

EXAMPLES OF MATERIALS TO BE WELDED

Steel grades/Standard	Type
Pipe material	
EN 10208	L360, L360NB, L360QB, L360MB, L415MB, L415NB, L450MB, L485MB
API 5LX	X52, X60, X65, X70
Fine grained steels	
EN 10025 part 3	S275, S355, S420, S460
EN 10025 part 6	S355, S420, S460, S500N, S460NL, S500NL, S500NC, S550NC

CALCULATION DATA

Diameter (mm)	Electrical stick-out (mm)	Wire Feed Speed (cm/min)	Current (A)	Arc Voltage (V)	Deposition rate (kg/h)	kg wire/kg weldmetal
1.2	20	445	130	20-22	1.6	1.20
		700	180	23-25	2.5	1.20
		950	220	25-27	3.4	1.20
		1270	265	27-29	4.5	1.20
		1590	305	30-32	5.9	1.20

WELDING PARAMETERS, OPTIMUM FILL PASSES IN SHIELDING GAS Ar + [-15-25]% CO₂

Diameter (mm)	Welding positions					
	PA/1G	PB/2F	PC/2G	PF/3Gup	PJ/5Gdown	PE/4G
1.2	230-280A	230-280A	200-240A	200-240A	200-240A	160-220A
	26-32V	26-32V	25-32V	25-28V	25-28V	23-28V

Pipeliner® G80M

CLASSIFICATION

AWS A5.29 : E101T1-GM-H8
EN 12535 : T 62 3 P M 2 H10

GENERAL DESCRIPTION

Mix gas shielded flux cored wire for semi-automatic and mechanized hot, fill and cap pass pipeline welding
Smooth, spray type arc transfer and low spatter level

Slag system provides for puddle support, good wetting and bead shape in all positions

All position single and multiple pass wire designed fo join pipe up to and including X80

For the root pass, the use of PIPELINER 70S-G or 80S-G is recommended

Reliable weld metal properties

Excellent wire feeding

In diameter 1.3 mm [0.052"] the wire is called PIPELINER AUTOWELD® G80M, and is designed to use with mechanized pipe welding systems.

PIPELINER AUTOWELD® G80M has tightly controlled cast and helix to assure proper wire placement every time

WELDING POSITIONS (ISO/ASME)



PA/1G



PB/2F



PC/2G



PG/3Gd



PE/4G



PJ/5Gd

CURRENT TYPE

DC +
M21 : Mixed gas Ar+ (>15-25%) CO₂
Amount : 15-25 l/min

CHEMICAL COMPOSITION (W%), TYPICAL, ALL WELD METAL

Shielding gas	C	Mn	Si	P	S	Ni	Cr	Mo
M21	0.04	1.75	0.4	0.015	0.01	0.95	0.11	0.25

MECHANICAL PROPERTIES, TYPICAL, ALL WELD METAL

	Shielding gas	Condition	Yield strength	Tensile strength	Elongation	Impact ISO-V(J)	
			(N/mm ²)	(N/mm ²)	(%)	-29°C/-30°C	-40°C
Required: AWS A5.29 EN 12535			min. 605 620	690-825 700-890	min. 16 min. 18		min. 47
Typical values	M21	AW	680	720	24	55	47

PACKAGING AND AVAILABLE SIZES

Diameter (mm)	1.1	1.3
4.5 kg plastic spool S200	X	X
11.34 kg coil 22RR	X	X

Pipeliner®G80M: rev. C-EN24-01/02/16

Pipeliner® G80M

EXAMPLES OF MATERIALS TO BE WELDED

Steel grades/Code	Type
Pipe material	
API 5LX	X70, X80
EN 10208-2	L485 up to L555

CALCULATION DATA

Diameter (mm)	Electrical stick-out (mm)	Wire Feed Speed (cm/min)	Current (A)	Arc Voltage (V)	Deposition rate (kg/h)	kg wire/ kg weldmetal
1.1	19	440-1020	130-275	23-30	1.8-4.1	1.21
1.3	19	380-1140	155-315	22-31	1.6-4.9	1.22

Pipeliner® G80M-E

CLASSIFICATION

AWS A5.29 : E91T1-GM-H4
 EN ISO : T 55 4 Z P M 2 H5
 18276-A

GENERAL DESCRIPTION

All position gas shielded 1% Ni and 0.4%Mo alloyed flux cored wire for offshore and pipeline applications
 Superior weldability, low spatter, good bead appearance and outstanding operators appeal
 Exceptional mechanical properties
 Very low hydrogen (HDM <5 ml/100g)
 Superior product consistency with optimal alloy control
 Excellent wire feeding
 Specific design to withstand high heat input procedures

WELDING POSITIONS



PA/1G



PB/2F



PC/2G



PG/3Gd



PE/4G



PJ/5Gd



PH/5Gu

CURRENT TYPE

DC +
 M21 : Mixed gas Ar+ (>15-25%) CO₂
 Amount : 15-25 l/min

CHEMICAL COMPOSITION (W%), TYPICAL, ALL WELD METAL

Shielding gas	C	Mn	Si	P	S	Ni	Mo
M21	0.06	1.4	0.3	0.013	0.01	0.95	0.4

MECHANICAL PROPERTIES, TYPICAL, ALL WELD METAL

	Shielding gas	Condition	Yield strength [N/mm ²]	Tensile strength [N/mm ²]	Elongation [%]	Impact ISO-V(J)	
						-40°C	-40°C
Required: AWS A5.29			min. 540	620-760	min. 17		
EN ISO 18276-A			min. 550	640-820	min. 18		min. 47
Typical values	M21	AW	695	740	21		65

PACKAGING AND AVAILABLE SIZES

Diameter (mm)	
1.2	
4.5 kg plastic spool S200	X
15 Kg spool B300	X

Pipeliner®G80ME: rev. C-EN07-11/05/16

All information in this data sheet is accurate to the best of our knowledge at the time of printing. Please refer to www.lincolnelectric.eu for any updated information.
 Fumes: Safety Data Sheets (SDS) are available on our website.

Pipelin[®]er G80M-E

EXAMPLES OF MATERIALS TO BE WELDED

Steel grades/Code	Type
Pipe material	
API 5LX	X60, X65, X70, X80
EN 10208-2	L360 up to L555

CALCULATION DATA

Diameter (mm)	Electrical stick-out (mm)	Wire Feed Speed (cm/min)	Current (A)	Arc Voltage (V)	Deposition rate (kg/h)	kg wire/kg weldmetal
1.2	20	445	130	20-22	1.6	1.20
		700	180	23-25	2.5	1.20
		950	220	25-27	3.4	1.20
		1270	265	27-29	4.5	1.20
		1590	305	30-32	5.9	1.20

WELDING PARAMETERS, OPTIMUM FILL PASSES IN SHIELDING GAS Ar + [-15-25]% CO₂

Diameter (mm)	Welding positions					
	PA/1G	PB/2F	PC/2G	PF/3Gup	PJ/5Gdown	PE/4G
1.2	230-280A	230-280A	200-240A	200-240A	200-240A	160-220A
	26-32V	26-32V	25-32V	25-28V	25-28V	23-28V

Pipeliner® G90M-E

CLASSIFICATION

AWS A5.29 : E11T1-GM-H4
 EN ISO : T 69 4 Z P M 2 H5
 18276-A

GENERAL DESCRIPTION

All position gas shielded rutile flux cored wire, for high strength steel grades like grade X70-X80
 Outstanding operator appeal
 Excellent mechanical properties (CVN >50J at -40°C)
 Very low hydrogen (HDM <5 ml/100g)
 Superior product consistency with optimal alloy control
 Excellent wire feeding

WELDING POSITIONS (ISO/ASME)



PA/1G



PB/2F



PC/2G



PG/3Gd



PE/4G



PJ/5Gd



PH/5Gu

CURRENT TYPE

DC +
 M21 : Mixed gas Ar+ (>15-25%) CO₂
 Amount : 15-25 l/min

CHEMICAL COMPOSITION (W%), TYPICAL, ALL WELD METAL

Shielding gas	C	Mn	Si	P	S	Ni	Mo
M21	0.06	1.5	0.2	0.015	0.010	2.0	0.5

MECHANICAL PROPERTIES, TYPICAL, ALL WELD METAL

	Shielding gas	Condition	Yield strength [N/mm ²]	Tensile strength [N/mm ²]	Elongation [%]	Impact ISO-V(J) -40°C
Required: AWS A5.29 EN ISO 18276-A			min. 680 min. 690	760-900 770-970	min. 15 min. 17	min. 47
Typical values	M21	AW	740	790	19	65

PACKAGING AND AVAILABLE SIZES

Diameter [mm]	1.2	1.6
4.5 kg plastic spool S200	X	
15 Kg spool B300	X	X

Pipeliner®G90ME: rev. C-EN07-11/05/16

Pipelin[®] G90M-E

EXAMPLES OF MATERIALS TO BE WELDED

Steel grades/Code	Type
Pipe material	
API 5LX	X70, X80
EN 10208-2	L485 up to L555

CALCULATION DATA

Diameter (mm)	Electrical stick-out (mm)	Wire Feed Speed (cm/min)	Current (A)	Arc Voltage (V)	Deposition rate (kg/h)	kg wire/kg weldmetal
1.2	20	445	130	20-22	1.6	1.20
		700	180	23-25	2.5	1.20
		950	220	25-27	3.4	1.20
		1270	265	27-29	4.5	1.20
		1590	305	30-32	5.9	1.20
1.6	20	320	170	21-23	1.9	1.20
		510	235	22-24	3.1	1.20
		635	275	24-25	3.9	1.20
		760	310	25-27	4.7	1.20
		890	350	27-29	5.6	1.20
		1015	385	28-30	6.4	1.20
		1080	400	30-31	6.8	1.20

WELDING PARAMETERS, OPTIMUM FILL PASSES IN SHIELDING GAS Ar + [-15-25]% CO₂

Diameter (mm)	Welding positions				
	PA/1G	PB/2F	PC/2G	PF/3Gup	PE/4G
1.2	230-280A	230-280A	200-240A	200-240A	160-220A
	26-32V	26-32V	25-32V	25-28V	23-28V
1.6	250-350A	250-350A	230-280A	220-260A	170-240A
	24-29V	24-29V	24-28V	24-26V	22-26V

Pipeliner® NR® -207+

CLASSIFICATION

AWS A5.29 : E71T8-K6

GENERAL DESCRIPTION

Optimum performance on vertical down hot, fill and cap pass welding in pipe steels such as API 5L X42 through X70
 Self-shielded, flux cored. No need for external gas or flux
 Produces quality welds in moderate wind conditions with no tenting
 Superior arc characteristics and feedability
 Very good crack resistance, CTOD and Charpy-V impact properties.

WELDING POSITIONS (ISO/ASME)



PA/1G



PB/2F



PC/2G



PG/3Gd



PE/4G



PJ/5Gd

CURRENT TYPE

DC -

CHEMICAL COMPOSITION (W%), TYPICAL, ALL WELD METAL

C	Mn	Si	P	S	Ni	Al
0.05	1.22	0.25	0.01	0.01	0.82	1.1

MECHANICAL PROPERTIES, TYPICAL, ALL WELD METAL

Condition	Yield strength (N/mm ²)	Tensile strength (N/mm ²)	Elongation (%)	Impact ISO-V(J) -29°C
Required: AWS A5.29 Typical values	min. 400 435	485-620 545	min. 20 30	min. 27 160
AW				

PACKAGING AND AVAILABLE SIZES

Diameter (mm)	2.0
6.35 kg coil 14C	X

Pipeliner® NR® -207+ rev. C-EN24-01/02/16

All information in this data sheet is accurate to the best of our knowledge at the time of printing. Please refer to www.lincolnelectric.eu for any updated information.
 Fumes: Safety Data Sheets (SDS) are available on our website.

Pipelin[®] NR[®] -207+

EXAMPLES OF MATERIALS TO BE WELDED

Steel grades/Code	Type
Pipe material	
API 5LX	X42, X46, X52, X56, X60, X65, X70
EN 10208-2	L290 up to L485

CALCULATION DATA

Diameter (mm)	Electrical stick-out (mm)	Wire Feed Speed (cm/min)	Current (A)	Arc Voltage (V)	Deposition rate (kg/h)
2.0	19	170-330	210-305	18-21	2.0-3.7

Pipelin[®] NR[®]-208XP

CLASSIFICATION

AWS A5.29 : E81T8-G

GENERAL DESCRIPTION

Optimum performance on vertical down hot, fill and cap pass welding in pipe steels such as API 5L X42 through X80
 Self-shielded, flux cored. No need for external gas or flux
 Produces quality welds in moderate wind conditions with no tenting
 Great arc characteristics and superior feedability
 Superior Charpy-V impact properties, consistent down to -29°C.
 For cold temperature, cross country pipe applications

WELDING POSITIONS (ISO/ASME)



PA/1G



PB/2F



PC/2G



PG/3Gd



PE/4G



PJ/5Gd

CURRENT TYPE

DC -

CHEMICAL COMPOSITION (W%), TYPICAL, ALL WELD METAL

C	Mn	Si	P	S	Ni	Cr	Mo	Al
0.02	2.15	0.12	0.005	0.002	0.75	0.04	0.02	1.0

MECHANICAL PROPERTIES, TYPICAL, ALL WELD METAL

Condition	Yield strength (N/mm ²)	Tensile strength (N/mm ²)	Elongation (%)	Impact ISO-V(J)
				-29°C
Required: AWS A5.29 Typical values	min. 470 495	500-690 570	min. 19 27	200

PACKAGING AND AVAILABLE SIZES

Diameter (mm)	2.0
6.35 kg coil 14C	X

Pipelin[®] NR[®]-208XP; rev. C-EN01-01/02/16

All information in this data sheet is accurate to the best of our knowledge at the time of printing. Please refer to www.lincolnelectric.eu for any updated information.
 Fumes: Safety Data Sheets (SDS) are available on our website.

Pipeliner® NR®-208XP

EXAMPLES OF MATERIALS TO BE WELDED

Steel grades/Code	Type
Pipe material	
API 5LX	X42, X46, X52, X56, X60, X65, X70, X80
EN 10208-2	L290 up to L555

CALCULATION DATA

Diameter (mm)	Electrical stick-out (mm)	Wire Feed Speed (cm/min)	Current (A)	Arc Voltage (V)	Deposition rate (kg/h)
2.0	19	170-330	195-295	17-20	1.8-3.5

Where are most weld defects found?

Most weld defects are found in weld roots. If access is available from only one side of the weld, the defects are usually a result of poor fusion. In two-side welds, the defects are usually slag inclusions that result from insufficient back grinding or gouging. Grinding and gouging are themselves costly and unpleasant procedures and, of course, the metal removed must be replaced by more weld metal. If defects are found, weld roots are the most difficult and expensive regions to repair.

How can we minimise root defects?

Since defect free fully penetrated root welds can be made only by highly qualified welders if no supporting backing is used, the Lincoln Electric LNB ceramic backing strips can be your answer. LNB products are ceramic backing strips that are attached to the back of weld roots. The ceramic is formulated to provide a molten surface contact that supports the weld root and breaks free when the metal cools. The backing is not permanent and is therefore permissible where permanent backing is not admissible, because of fatigue or corrosion.



What are the major benefits of Lincoln Electric LNB backing materials?

- Weld roots can be made at higher currents, thereby ensuring good fusion.
- Quality of root welds is less dependent on welder skills.
- Minimised overhead welding. Deck welds can be made from above.
- Less re-positioning of work. Work pieces need not be moved to allow welding of the back of joints.
- Less defects. Better root fusion ensures lower defect levels.
- More tolerant of fit-up. The use of a bigger weld pool supported by the ceramic, allows larger and mis-matched gaps to be filled with sound weld metal.
- Purging with inert gas is not necessary to protect the back of the weld root.

What are the features of Lincoln Electric LNB materials?

- LNB products do not absorb moisture. They are made from high density, non-hygroscopic ceramics. In combination with Lincoln Electric low hydrogen consumables, they give maximum security when welding materials are susceptible to hydrogen induced cracking.
- LNB materials are inert and do not introduce undesirable elements into the weld pool.
- LNB products control weld back reinforcement. The weld metal that cools in contact with the ceramic is smooth, slightly convex and it usually needs no further cleaning or grinding.
- LNB products are easy to attach to the back of welds, and they will withstand normal preheat temperatures. Either aluminium adhesive tape or spring steel clips hold the ceramic in firm contact with the joint. The weld metal is not adversely effected by its contact with the ceramic strips.
- LNB strips can be used with many materials, like structural steels, low-alloy and stainless steels as well as many processes such as stick electrodes and most standard solid wires for CO₂ and mixed gas metal arc welding. In combination with Outershield, Cor-A-Rosta or other flux cored wires and Innershield self shielded wires, as well as submerged arc processes, they add substantially to the already high productivity.
- LNB ceramic backing strips are made in a variety of shapes and sizes that are suitable for most welds.
- No release of disagreeable gases during welding.

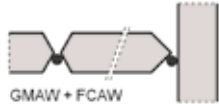
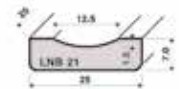
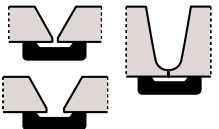
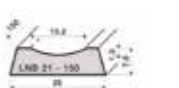
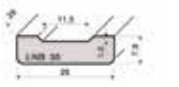
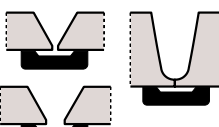
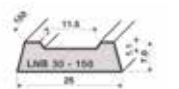
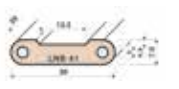
PRODUCT RANGE

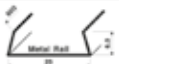
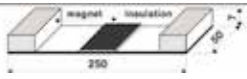
 <p>LNB 6 : D = 6 LNB 9 : D = 9 LNB 12 : D = 11,3</p> <p>Strip length 600 mm</p>	<p>Products</p> <table border="1"> <thead> <tr> <th>Item</th> <th>Pcs/box</th> <th>mtr/box</th> </tr> </thead> <tbody> <tr> <td>LNB 6 tape 640007</td> <td>100</td> <td>60</td> </tr> <tr> <td>LNB 9 tape 640014</td> <td>72</td> <td>43,2</td> </tr> <tr> <td>LNB 12 tape 640021</td> <td>60</td> <td>36</td> </tr> </tbody> </table> <p>Mainly for mild steel. For general steel structures</p>	Item	Pcs/box	mtr/box	LNB 6 tape 640007	100	60	LNB 9 tape 640014	72	43,2	LNB 12 tape 640021	60	36	 <p>GMAW + FCAW</p>
Item	Pcs/box	mtr/box												
LNB 6 tape 640007	100	60												
LNB 9 tape 640014	72	43,2												
LNB 12 tape 640021	60	36												
 <p>Strip length 600 mm</p>	<p>Products</p> <table border="1"> <thead> <tr> <th>Item</th> <th>Pcs/box</th> <th>mtr/box</th> </tr> </thead> <tbody> <tr> <td>LNB 21 tape 640083</td> <td>56</td> <td>33.6</td> </tr> </tbody> </table>	Item	Pcs/box	mtr/box	LNB 21 tape 640083	56	33.6							
Item	Pcs/box	mtr/box												
LNB 21 tape 640083	56	33.6												
 <p>Strip length 600 mm</p>	<p>Products</p> <table border="1"> <thead> <tr> <th>Item</th> <th>Pcs/box</th> <th>mtr/box</th> </tr> </thead> <tbody> <tr> <td>LNB 21-150 tape 640090</td> <td>56</td> <td>33.6</td> </tr> <tr> <td>LNB 21-150 rail 640021</td> <td>63</td> <td>37.8</td> </tr> </tbody> </table>	Item	Pcs/box	mtr/box	LNB 21-150 tape 640090	56	33.6	LNB 21-150 rail 640021	63	37.8	<p>To be used with LNM solid wires and metal cored wires like Outershield MC 710-H and Outershield MC 715-H</p>			
Item	Pcs/box	mtr/box												
LNB 21-150 tape 640090	56	33.6												
LNB 21-150 rail 640021	63	37.8												
 <p>Strip length 600 mm</p>	<p>Products</p> <table border="1"> <thead> <tr> <th>Item</th> <th>Pcs/box</th> <th>mtr/box</th> </tr> </thead> <tbody> <tr> <td>LNB 30 tape 640151</td> <td>56</td> <td>33.5</td> </tr> </tbody> </table>	Item	Pcs/box	mtr/box	LNB 30 tape 640151	56	33.5							
Item	Pcs/box	mtr/box												
LNB 30 tape 640151	56	33.5												
 <p>Strip length 600 mm</p>	<p>Products</p> <table border="1"> <thead> <tr> <th>Item</th> <th>Pcs/box</th> <th>mtr/box</th> </tr> </thead> <tbody> <tr> <td>LNB 30-150 tape 640168</td> <td>56</td> <td>33.6</td> </tr> <tr> <td>LNB 30-150 rail 640175</td> <td>63</td> <td>37.8</td> </tr> </tbody> </table>	Item	Pcs/box	mtr/box	LNB 30-150 tape 640168	56	33.6	LNB 30-150 rail 640175	63	37.8	<p>To be used with flux-cored wires like Outershield and Cor-A-Rosta</p>			
Item	Pcs/box	mtr/box												
LNB 30-150 tape 640168	56	33.6												
LNB 30-150 rail 640175	63	37.8												
 <p>Strip length 600 mm Strip length 1000 mm</p>	<p>Products</p> <table border="1"> <thead> <tr> <th>Item</th> <th>Pcs/box</th> <th>mtr/box</th> </tr> </thead> <tbody> <tr> <td>LNB 40 tape 640243</td> <td>48</td> <td>28.8</td> </tr> <tr> <td>LNB 41 rail 640229</td> <td>24</td> <td>24</td> </tr> </tbody> </table> <p>Elements are mounted on flexible wire Suitable for pipe and cylindrical parts Designed to bend easily</p>	Item	Pcs/box	mtr/box	LNB 40 tape 640243	48	28.8	LNB 41 rail 640229	24	24				
Item	Pcs/box	mtr/box												
LNB 40 tape 640243	48	28.8												
LNB 41 rail 640229	24	24												
	<p>Magnetic clamp, item 640236</p>													

PACKAGING SOLUTIONS

MIG & FLUX-CORED WIRES

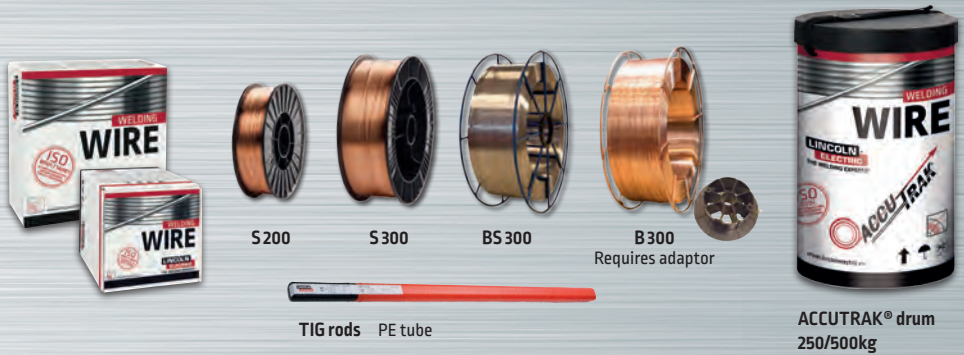

S200

S300

BS300

B300
Requires adaptor

TIG rods PE tube

ACCUTRAK® drum
250/500kg

SUBMERGED ARC FLUX AND WIRES

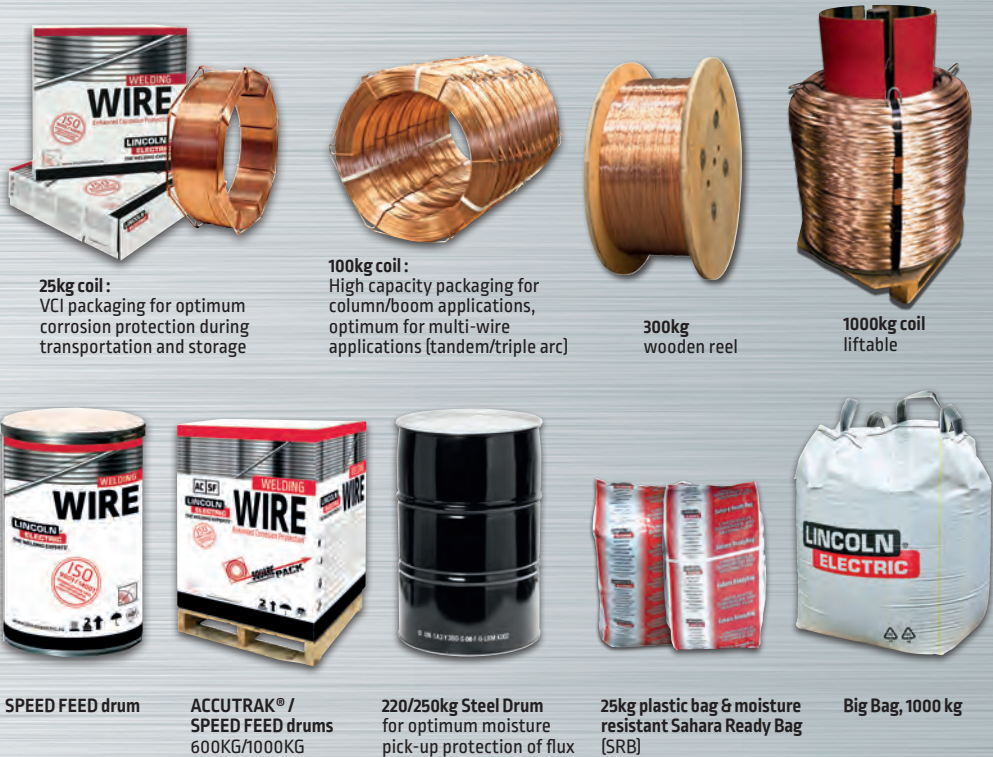

25kg coil:
VCI packaging for optimum
corrosion protection during
transportation and storage

100kg coil:
High capacity packaging for
column/boom applications,
optimum for multi-wire
applications (tandem/triple arc)

300kg
wooden reel

1000kg coil
lifttable

SPEED FEED drum

ACCUTRAK® /
SPEED FEED drums
600KG/1000KG

220/250kg Steel Drum
for optimum moisture
pick-up protection of flux

25kg plastic bag & moisture
resistant Sahara Ready Bag
[SRB]

Big Bag, 1000 kg



www.lincolnelectric.eu

CUSTOMER ASSISTANCE POLICY

The business of Lincoln Electric Europe is manufacturing and selling high quality welding equipment, consumables and cutting equipment. Our challenge is to meet the needs of the customer and to exceed their expectations. On occasion, purchasers may ask Lincoln Electric for advice or information about their use of our products. We respond to our customers based on the best information in our possession at that time. Lincoln Electric is not in a position to warrant or guarantee such advice and assumes no responsibility, with respect to such information or advice. We expressly disclaim any warranty of any kind, including any warranty of fitness for any customer's particular purpose, with respect to such information or advice. As a matter of practical consideration, we also cannot assume any responsibility for updating or correcting any such information or advice once it has been given, nor does the provision of information or advice create, expand or alter any warranty with respect to the sale of our products. Lincoln Electric is a responsive manufacturer, but the selection and use of specific products sold by Lincoln Electric is solely within the control of, and remains the sole responsibility of the customer. Many variables beyond the control of Lincoln Electric affect the results obtained in applying these types of fabrication methods and service requirements. Subject to change – this information is accurate to the best of our knowledge at the time of printing.